



EUROPEAN COMMISSION

**Integrated Pollution Prevention and Control**

Reference Document on the Best Available  
Techniques for

# **Waste Incineration**

August 2006

This document is one of a series of foreseen documents as below (at the time of writing, not all documents have been drafted):

<b>Reference Document on Best Available Techniques . . .</b>	<b>Code</b>
Large Combustion Plants	LCP
Mineral Oil and Gas Refineries	REF
Production of Iron and Steel	I&S
Ferrous Metals Processing Industry	FMP
Non Ferrous Metals Industries	NFM
Smitheries and Foundries Industry	SF
Surface Treatment of Metals and Plastics	STM
Cement and Lime Manufacturing Industries	CL
Glass Manufacturing Industry	GLS
Ceramic Manufacturing Industry	CER
Large Volume Organic Chemical Industry	LVOC
Manufacture of Organic Fine Chemicals	OFC
Production of Polymers	POL
Chlor – Alkali Manufacturing Industry	CAK
Large Volume Inorganic Chemicals - Ammonia, Acids and Fertilisers Industries	LVIC-AAF
Large Volume Inorganic Chemicals - Solid and Others industry	LVIC-S
Production of Speciality Inorganic Chemicals	SIC
Common Waste Water and Waste Gas Treatment/Management Systems in the Chemical Sector	CWW
Waste Treatments Industries	WT
<i>Waste Incineration</i>	<i>WI</i>
Management of Tailings and Waste-Rock in Mining Activities	MTWR
Pulp and Paper Industry	PP
Textiles Industry	TXT
Tanning of Hides and Skins	TAN
Slaughterhouses and Animals By-products Industries	SA
Food, Drink and Milk Industries	FDM
Intensive Rearing of Poultry and Pigs	ILF
Surface Treatment Using Organic Solvents	STS
Industrial Cooling Systems	CV
Emissions from Storage	ESB
<b>Reference Document . . .</b>	
General Principles of Monitoring	MON
Economics and Cross-Media Effects	ECM
Energy Efficiency Techniques	ENE

## EXECUTIVE SUMMARY

The BAT (Best Available Techniques) Reference Document (BREF) entitled Waste Incineration (WI) reflects an information exchange carried out under Article 16(2) of Council Directive 96/61/EC (IPPC Directive). This executive summary describes the main findings, a summary of the principal BAT conclusions and the associated consumption and emission levels. It should be read in conjunction with the preface, which explains this document's objectives; how it is intended to be used and legal terms. It can be read and understood as a standalone document but, as a summary, it does not present all the complexities of this full document. It is therefore not intended as a substitute for this full document as a tool in BAT decision making.

### Scope of this document

The scope of this document is based on Sections 5.1 and 5.2 of Annex 1 of the IPPC Directive 96/61/EC, in so far as they deal with incineration of waste. The scope chosen for the work was not restricted by the installation size limitations in the IPPC Directive, nor by the definitions of waste, recovery or disposal included therein. The selected scope therefore intended to provide a pragmatic view across the incineration sector as a whole, with a particular focus upon those installation and waste types that are most common. The scope of the Waste Incineration Directive was also a factor taken into account when deciding on the scope of the BREF document. The final contents of the BREF reflect the information that was submitted during the information exchange by the TWG.

The document deals only with the dedicated incineration of waste and not with other situations where waste is thermally treated, e.g. co-incineration processes such as cement kilns and large combustion plants.

Although incineration provides the main focus of the document, it also includes some information on waste pyrolysis and gasification systems.

This BREF document does not:

- deal with decisions concerning the selection of incineration as a waste treatment option
- compare waste incineration with other waste treatment options.

### Waste Incineration (WI)

Incineration is used as a treatment for a very wide range of wastes. Incineration itself is commonly only one part of a complex waste treatment system that altogether, provides for the overall management of the broad range of wastes that arise in society.

The incineration sector has undergone rapid technological development over the last 10 to 15 years. Much of this change has been driven by legislation specific to the industry and this has, in particular, reduced emissions to air from individual installations. Continual process development is ongoing, with the sector now developing techniques which limit costs, whilst maintaining or improving environmental performance.

The objective of waste incineration, in common with most waste treatments, is to treat waste so as to reduce its volume and hazard, whilst capturing (and thus concentrating) or destroying potentially harmful substances. Incineration processes can also provide a means to enable recovery of the energy, mineral and/or chemical content from waste.

Basically, waste incineration is the oxidation of the combustible materials contained in the waste. Waste is generally a highly heterogeneous material, consisting essentially of organic substances, minerals, metals and water. During incineration, flue-gases are created that will contain the majority of the available fuel energy as heat. The organic substances in the waste will burn when they have reached the necessary ignition temperature and come into contact with oxygen. The actual combustion process takes place in the gas phase in fractions of seconds and simultaneously releases energy. Where the calorific value of the waste and oxygen supply is sufficient, this can lead to a thermal chain reaction and self-supporting combustion, i.e. there is no need for the addition of other fuels.

Although approaches vary greatly, the incineration sector may approximately be divided into the following main sub-sectors:

- i. Mixed municipal waste incineration – treating typically mixed and largely untreated household and domestic wastes but may sometimes including certain industrial and commercial wastes (industrial and commercial wastes are also separately incinerated in dedicated industrial or commercial non-hazardous waste incinerators).
- ii. Pretreated municipal or other pretreated waste incineration – installations that treat wastes that have been selectively collected, pretreated, or prepared in some way, such that the characteristics of the waste differ from mixed waste. Specifically prepared refuse derived fuel incinerators fall in this sub-sector
- iii. Hazardous waste incineration - this includes incineration on industrial sites and incineration at merchant plants (that usually receive a very wide variety of wastes)
- iv. Sewage sludge incineration – in some locations sewage sludges are incinerated separately from other wastes in dedicated installations, in others such waste is combined with other wastes (e.g. municipal wastes) for its incineration
- v. Clinical waste incineration – dedicated installations for the treatment of clinical wastes, typically those arising at hospitals and other healthcare institutions, exist as centralised facilities or on the site of individual hospital etc. In some cases certain clinical wastes are treated in other installations, for example with mixed municipal or hazardous wastes.

Data in this document shows that, at the time of its compilation:

- Around 20 - 25 % of the municipal solid waste (MSW) produced in the EU-15 is treated by incineration (total MSW production is close to 200 million tonnes per year)
- The percentage of MSW treated by incineration in individual Member States of the EU-15 varies from 0 % to 62 %
- The total number of MSW installations in the EU-15 is over 400
- Annual MSW incineration capacity in individual European countries varies from 0 kg to over 550 kg per capita
- In Europe the average MSW incinerator capacity is just under 200000 tonnes per year.
- The average throughput capacity of the MSWI installations in each MS also varies. The smallest plant size average seen is 60000 tonnes per year and the largest close to 500000 tonnes per year
- Around 12 % of the hazardous waste produced in EU-15 is incinerated (total production close to 22 million tonnes per year).

Expansion of the MSW incineration sector is anticipated in Europe over the next 10 – 15 years as alternatives are sought for the management of wastes diverted from landfill by the Landfill Directive and both existing and new Member States examine and implement their waste management strategies in the light of this legislation.

## **Key environmental issues**

Waste and its management are a significant environmental issue. The thermal treatment of waste may therefore be seen as a response to the environmental threats posed by poorly or unmanaged waste streams. The target of thermal treatment is to provide for an overall reduction in the environmental impact that might otherwise arise from the waste. However, in the course of the operation of incineration installations, emissions and consumptions arise, whose existence or magnitude is influenced by the installation design and operation.

The potential impacts of waste incineration installations themselves fall into the following main categories:

- overall process emissions to air and water (including odour)
- overall process residue production
- process noise and vibration
- energy consumption and production
- raw material (reagent) consumption
- fugitive emissions – mainly from waste storage
- reduction of the storage/handling/processing risks of hazardous wastes.

Other impacts beyond the scope of this BREF document (but which can significantly impact upon the overall environmental impact of the whole chain of waste management) arise from the following operations:

- transport of incoming waste and outgoing residues
- extensive waste pretreatment (e.g. preparation of waste derived fuels).

The application and enforcement of modern emission standards, and the use of modern pollution control technologies, has reduced emissions to air to levels at which pollution risks from waste incinerators are now generally considered to be very low. The continued and effective use of such techniques to control emissions to air represents a key environmental issue.

Other than its role in ensuring effective treatment of otherwise potentially polluting unmanaged wastes, many waste incineration installations have a particular role as an energy-from-waste recovery process. Where policies have been implemented to increase the ability of, (most commonly municipal) waste incineration installations to recover the energy value of the waste, this increases the exploitation of this positive environmental contribution. A significant environmental opportunity for the industry is therefore to increase its potential as an energy supplier.

## **Applied processes and techniques**

Chapter 2 of this document provides a description of the processes and techniques that are applied in the waste incineration industry. It focuses upon the most commonly applied thermal treatment of incineration, but also includes information on gasification and pyrolysis. The following main activities and areas are described to varying degrees of detail:

- incoming waste reception
- storage of waste and raw materials
- pretreatment of waste (mainly on-site treatments and blending operations)
- loading of waste into the furnace
- techniques applied at the thermal treatment stage (furnace design etc.)
- the energy recovery stage (e.g. boiler and energy supply options)
- flue-gas cleaning techniques (grouped by substance)
- flue-gas cleaning residue management
- emissions monitoring and control
- waste water control and treatment (e.g. from site drainage, flue-gas treatment, storage)
- ash/bottom ash management and treatment (arising from the combustion stage).

Where techniques are specific to certain types of wastes, relevant sections are subdivided according to waste type.

### Consumptions and emissions

The emissions, and material and energy consumptions, that arise from waste incineration installations are described in Chapter 3. Available data are presented on installation emissions to air and water, noise, and residues. Information on raw material consumptions is also provided, along with a section that focuses upon energy consumption and output. Most of the data are whole installation data arising from industrial surveys. Some information about the techniques applied in order to achieve these emission levels is also included.

Although some European installations have yet to be upgraded, the industry is generally achieving operational levels that meet or improve upon the air emission limit values set in Directive 2000/76/EC.

In circumstances where CHP or heat (as heat or steam) can be supplied, it is possible for very large percentages of the energy value of the waste (approx. 80 % in some cases) to be recovered.

### Techniques to consider in the determination of BAT

Each technique described in Chapter 4 includes the available relevant information, on: the consumption and emission levels achievable using the technique; some idea of the costs and the cross-media issues associated with the technique, and; information on the extent to which the technique is applicable to the range of installations requiring IPPC permits - for example new, existing, large or small installations, and to various waste types. Management systems, process-integrated techniques and end-of-pipe measures are included.

The techniques that are included are those that are considered to have the potential to achieve, or contribute to, a high level of environmental protection in the waste incineration industry. The final BAT, as agreed by the TWG, is not covered in Chapter 4, but in Chapter 5. The inclusion of a technique in Chapter 4, but not in Chapter 5 should not be taken as an indication that the technique is not and cannot be BAT - the rationale for excluding the technique from Chapter 5 could, for example, be that the TWG felt that the technique not sufficiently widely applicable for it to be described as *BAT in general*. Furthermore, because it is not possible to be exhaustive and because the situation is dynamic, Chapter 4 cannot be considered to be entirely comprehensive. Other techniques may also provide for levels of performance that meet or exceed the BAT criteria later established in Chapter 5, and when applied locally those techniques may provide particular advantages in the situation in which they are used.

The techniques included are grouped in approximately the order in which they would appear in the majority of waste incineration installations. The table below gives the title of the chapter subsections and indicates the grouping to which the techniques are listed.

Chapter 4 section number	Title of section
4.1	General practices applied before thermal treatment
4.2	Thermal processing
4.3	Energy recovery
4.4	Flue-gas treatment
4.5	Process water treatment and control
4.6	Treatment techniques for solid residues
4.7	Noise
4.8	Environmental management tools
4.9	Good practice for public awareness and communication

**Table: Organisation chart for the information in Chapter 4**

Chapter 4 concentrates on techniques that provide particular advantages at each of the main stages generally seen in waste incineration installations. Dividing the techniques in this way does however mean that, although mentioned in some cases, the important aspect of the overall integration of all of the techniques in an installation (sometimes referred to in the BREF as their “inter-process compatibility”) is something which requires careful consideration when reading the individual sections of Chapter 4. The subsections on *operational data* and *applicability* are generally where such matters are given consideration. Overall compatibility was also been given further consideration when finally deriving the BAT conclusions in Chapter 5.

Chapter 4 does not generally describe in detail those techniques that, whilst they provide, or contribute to, a high level of environmental performance, are so common that their use may already be considered as standard. An example of this is that, because the applicability of the main combustor designs to the main waste streams is relatively well established, the techniques considered at this stage concentrate mainly on:

- a) the general issue of ensuring the combustion system selected is properly matched to the wastes fed to it, and
- b) on some aspects relating to improving combustion performance e.g. waste preparation, air supply control, etc.

### **BAT for the incineration of waste**

The BAT chapter (Chapter 5) identifies those techniques that the TWG considered to be BAT in a general sense, based on the information in Chapter 4, taking into account the Article 2(11) definition of best available techniques and the considerations listed in Annex IV of the Directive.

The BAT chapter does not set or propose emission limit values but suggests the operational consumption and emission values that are associated with the use of BAT. The introduction to Chapter 5 included in this BREF is specifically extended to clarify certain issues that were considered to be of particular relevance to the waste incineration industry, including the links between the Waste Incineration Directive (WID) and IPPC (see the PREFACE of the BREF). These additional specific issues include:

- the difference between WID emission limit values and BAT performance
- the relationship between BAT and site selection
- how to understand and use the BAT described in Chapter 5.

The following paragraphs summarise the key BAT conclusions but **reference must be made to the BAT chapter itself to be comprehensive**. The generic BAT are intended to apply to the whole sector (i.e. waste incineration, waste gasification and waste pyrolysis of whatever type of waste). Other BAT are given that apply to sub-sectors dealing primarily with specific waste streams. It is therefore anticipated that a specific installation would apply a combination of the generic and waste specific BAT, and that installations treating mixtures of waste, or wastes not specifically mentioned, would apply the generic BAT plus a suitable selection of the waste specific BAT. Further comment on the combining of the BAT is included in the introduction to Chapter 5.

### **Generic BAT**

A fundamental BAT stresses the importance of the selecting an installation design that is suited to the characteristics of the waste received at the installation in terms of both its physical and chemical characteristics. This BAT is fundamental to ensuring the installation may treat the waste received with a minimum of process disturbances – which themselves may give rise to additional environmental impacts. To this end there is also a BAT about the minimisation of planned and unplanned shutdowns.

BAT includes establishing and maintaining quality controls over the waste input. This aims to ensure that the waste characteristics remain suited to the design of the receiving installation. Such quality control procedures are compatible with the application of an environmental management system, which is also considered BAT.

There are several BAT regarding the conditions and management of the storage of incoming wastes prior to their treatment, so that this does not give rise to pollution and odour releases. Some specific techniques and conditions of storage are noted. A risk based approach that takes into account the properties of the waste concerned is considered BAT.

Consideration of the demonstrated ability of some installation designs to very efficiently treat highly heterogeneous wastes (e.g. mixed MSW), and the risks and cross-media effects associated with pretreatment, results in a conclusion that it is BAT to pretreat incoming wastes to the degree required to meet the design specification for the receiving installation, noting that to treat wastes beyond this requires balanced consideration of (possibly limited) benefits, operational factors and cross-media effects.

The design and operation of the combustion stage is identified as an important primary pollution prevention aspect, and therefore of great relevance to achieving the aims of the IPPC Directive. It is noted in the BAT chapter that flow modelling at the design stage may assist in ensuring that certain key design decisions are well informed. In operation, it is considered BAT to use various techniques (e.g. control of air supply and distribution) to control combustion. The BAT regarding the selection of a design that suits the waste received is of particular relevance here.

In general the use of the combustion operating conditions specified in Article 6 of Directive 2000/76/EC (WID) are considered to be compatible with BAT. However the TWG noted, that the use of conditions in excess of these (e.g. higher temperatures) could result in an overall deterioration in environmental performance, and that there were several examples of hazardous waste installations that had demonstrated an overall improvement in environmental performance when using lower operational temperatures than the 1100 °C specified in WID for certain hazardous wastes. The general BAT conclusion was that the combustion conditions (e.g. temperature) should be sufficient to achieve the destruction of the waste but, in order to limit potential cross-media impacts, generally not significantly in excess of those conditions. The provision of auxiliary burner(s) for achieving and maintaining operational conditions is considered to be BAT when waste is being burned.

When gasification or pyrolysis is used, in order to prevent the generation of waste by disposal of the reaction products of these techniques, it is BAT either, to recover the energy value from the products using a combustion stage, or to supply them for use. The BAT associated emission levels for releases to air from the combustion stage of such installations are the same as those established for incineration installations.

The recovery of the energy value of the waste is a key environmental issue for the sector, presenting an area where the sector may make a significant positive contribution. Several BAT cover this aspect, dealing with:

- specific techniques that are considered to be BAT
- the heat transfer efficiencies expected of boilers
- the use of CHP, district heating, industrial steam supply and electricity production
- the recovery efficiencies that may be anticipated.



With CHP and steam/heat supply generally offering the greatest opportunity for increasing energy recovery rates, policies affecting the availability of suitable customers for steam/heat generally play a far greater role in determining the efficiency achievable at an installation than the detail of its design. For mainly policy and economic reasons, electricity generation and supply is often the energy recovery option selected at individual installations. Options for CHP, district heating and industrial steam supply are only well exploited in a few European Member States – generally those that have high heat prices and/or that have adopted particular policies. The supply of energy for the operation of cooling systems and desalination plants is something that is done, but is in general poorly exploited – such an option may be of particular interest in warmer climate zones, and in general expands the options for the supply of waste derived energy.

The flue-gas treatments applied at waste incineration installations have been developed over many years in order to meet stringent regulatory standards and are now highly technically advanced. Their design and operation are critical to ensure that all emissions to air are well controlled. The BAT that are included:

- cover the process of selection of FGT systems
- describe several specific techniques which are considered to be BAT
- describe the performance levels that are anticipated from the application of BAT.

The performance ranges agreed by the wider TWG resulted in some split views. These were mainly from one Member State and the Environmental NGO, who believed that lower emission values than the ranges agreed by the remainder of the TWG could also be considered to be BAT.

The BAT regarding waste water control include:

- the in-process recirculation of certain effluents
- the separation of drainage for certain effluents
- the use of on-site effluent treatment for wet scrubber effluents
- BAT associated performance levels for emissions from scrubber effluent treatment
- the use of specific techniques.

The performance ranges agreed by the wider TWG resulted in some split views from one Member State and the Environmental NGO, who believed that lower emission values than the ranges given could also be considered to be BAT.

BAT regarding residue management include:

- a bottom ash burnout TOC level of below 3 %, with typical values falling between 1 and 2 %
- a list of techniques, which when suitably combined may attain these burnout levels
- the separate management of bottom ash from fly ash and a requirement to assess each stream produced
- the extraction of ferrous and non-ferrous metals from ash for their recovery (where present in ash to sufficient degree to make this viable)
- the treatment of bottom ashes and other residues using certain techniques - to the extent required for them to meet the acceptance criteria at the receiving recovery or disposal site.

In addition to these generic BAT, more specific BAT are identified for those sub-sectors of the industry treating mainly the following wastes:

- municipal wastes
- pretreated or selected municipal wastes
- hazardous wastes
- sewage sludge
- clinical waste.

The specific BAT provide, where it has been possible, more detailed BAT conclusions. These conclusions deal with the following waste stream specific issues:

- in-coming waste management, storage and pretreatment
- combustion techniques
- energy recovery performance.

### Emerging techniques

The section on emerging techniques is not comprehensive. A number of the techniques supplied by the TWG and included in earlier drafts of this document were transferred into this section. In the majority of cases the techniques included have only been demonstrated on a pilot or trial scale.

The degree of demonstration (as measured by overall throughput and operational hours) of pyrolysis and gasification on the main European waste streams is low compared with incineration and operational difficulties are reported at some installations. However, both gasification and pyrolysis are applied in the sector and therefore, according to the BREF definition, cannot be considered to be *emerging techniques*. For this reason the information concerning these techniques is included in Chapter 4.

### Concluding remarks

#### Information exchange

This BREF is based on several hundred sources of information, and over 7000 consultation comments supplied by a very large working group. Some of the information was overlapping and therefore, not all of the documents supplied are referenced in the BREF. Both industry and Member States supplied important information. Data quality was generally good, particularly for emissions to air, allowing valid comparisons to be made in some cases. This was not however uniformly the case, and data regarding costs was difficult to compare owing to inconsistencies in data compilation and reporting. The consumption and emissions data given are predominantly for whole installations or groups of techniques, rather than individual ones. This has led to some important BAT conclusions being expressed as quantitative overall performance targets, with certain technical options presented that when suitably combined, may give rise to that performance.

#### Level of consensus

There was a very good general level of consensus. There was full agreement, and no split views, in relation to the technique related BAT. There was also generally good consensus upon the quantitative BAT, although the operational emission levels associated with the use of BAT did give rise to some split views, with one Member State and the Environmental NGO recording split views in relation to many of the BAT associated emission levels for releases to both air and water.

**Recommendations for future work and R&D projects**

The information exchange and its result, i.e. this BREF, provide a step forward in achieving the integrated prevention and control of pollution from waste incineration. Further work could continue the process by providing:

- information regarding the techniques used to, and costs of, upgrading existing installations – such information may be derived from experience of implementing WID in Member States and might usefully be compared with the costs/performance at new installations
- the more detailed cost information that is required to undertake a more precise assessment of variations in technique affordability with plant size and waste type
- information regarding smaller installations – very little information was provided regarding small installations
- information regarding installations that treat industrial non-hazardous wastes and the impact on installations of treating mixtures of wastes e.g. sewage sludge or clinical waste with MSW
- a more detailed evaluation of the impact on pollution prevention of detailed combustion design features e.g. grate design
- further information on emerging techniques.
- ammonia consumption and emission (mainly to air and water) levels for different FGT systems (mainly wet, semi-wet and dry) and their relative NO<sub>x</sub> reduction efficiency
- the impact of the dust removal temperature range upon PCDD/F releases to air and residues
- further experiences with continuous emissions monitoring for Hg (to air and water).

Other important recommendations for further work beyond the scope of this BREF but arising from the information exchange are:

- the need for consideration of the overall impact of competition for waste treatment, in particular competition from industries co-incinerating wastes – a study of such might usefully include consideration of: relative reliability of, and risks to, the supply of the total waste management service; overall emissions and energy recovery according to various degrees of diversion, and; consider and identify key risk factors e.g. waste fuel quality assurance.
- it may be useful to assess the impact on adopted waste strategies (i.e. the balance of technologies used on a national scale), and on achieved thermal treatment installation efficiencies, of the degree of integration of energy and waste management policy in EU Member States (and other countries). Such studies may identify how policy on energy and waste interact and give examples, both positive and negative.
- the need to understand in more detail of the impact of absolute and relative energy prices (for electricity and heat) upon the typically achieved energy efficiency of installations, and the role and impact of subsidies and taxation schemes
- the identification of the typical barriers to developing new installations and the approaches that have proved successful
- the development of suitable standards for the use of bottom ash – such standards have proved helpful in improving markets for the use of bottom ash
- the costs and benefits of further reducing emissions from the waste incineration industry when compared to reductions at other industrial and anthropogenic sources of pollution.

The EC is launching and supporting, through its RTD programmes, a series of projects dealing with clean technologies, emerging effluent treatment and recycling technologies and management strategies. Potentially these projects could provide a useful contribution to future BREF reviews. Readers are therefore invited to inform the EIPPCB of any research results which are relevant to the scope of this document (see also the preface of this document).



---

## PREFACE

### 1. Status of this document

Unless otherwise stated, references to “the Directive” in this document means the Council Directive 96/61/EC on integrated pollution prevention and control. As the Directive applies without prejudice to Community provisions on health and safety at the workplace, so does this document.

This document forms part of a series presenting the results of an exchange of information between EU Member States and industries concerned on best available technique (BAT), associated monitoring, and developments in them. It is published by the European Commission pursuant to Article 16(2) of the Directive, and must therefore be taken into account in accordance with Annex IV of the Directive when determining “best available techniques”.

### 2. Relevant legal obligations of the IPPC Directive and the definition of BAT

In order to help the reader understand the legal context in which this document has been drafted, some of the most relevant provisions of the IPPC Directive, including the definition of the term “best available techniques”, are described in this preface. This description is inevitably incomplete and is given for information only. It has no legal value and does not in any way alter or prejudice the actual provisions of the Directive.

The purpose of the Directive is to achieve integrated prevention and control of pollution arising from the activities listed in its Annex I, leading to a high level of protection of the environment as a whole. The legal basis of the Directive relates to environmental protection. Its implementation should also take account of other Community objectives such as the competitiveness of the Community’s industry thereby contributing to sustainable development.

More specifically, it provides for a permitting system for certain categories of industrial installations requiring both operators and regulators to take an integrated, overall look at the polluting and consuming potential of the installation. The overall aim of such an integrated approach must be to improve the management and control of industrial processes so as to ensure a high level of protection for the environment as a whole. Central to this approach is the general principle given in Article 3 that operators should take all appropriate preventative measures against pollution, in particular through the application of best available techniques enabling them to improve their environmental performance.

The term “best available techniques” is defined in Article 2(11) of the Directive as “the most effective and advanced stage in the development of activities and their methods of operation which indicate the practical suitability of particular techniques for providing in principle the basis for emission limit values designed to prevent and, where that is not practicable, generally to reduce emissions and the impact on the environment as a whole.” Article 2(11) goes on to clarify further this definition as follows:

“techniques” includes both the technology used and the way in which the installation is designed, built, maintained, operated and decommissioned;

“available” techniques are those developed on a scale which allows implementation in the relevant industrial sector, under economically and technically viable conditions, taking into consideration the costs and advantages, whether or not the techniques are used or produced inside the Member State in question, as long as they are reasonably accessible to the operator;

“best” means most effective in achieving a high general level of protection of the environment as a whole.

Furthermore, Annex IV of the Directive contains a list of “considerations to be taken into account generally or in specific cases when determining best available techniques... bearing in mind the likely costs and benefits of a measure and the principles of precaution and prevention”. These considerations include the information published by the Commission pursuant to Article 16(2).

Competent authorities responsible for issuing permits are required to take account of the general principles set out in Article 3 when determining the conditions of the permit. These conditions must include emission limit values, supplemented or replaced where appropriate by equivalent parameters or technical measures. According to Article 9(4) of the Directive, these emission limit values, equivalent parameters and technical measures must, without prejudice to compliance with environmental quality standards, be based on the best available techniques, without prescribing the use of any technique or specific technology, but taking into account the technical characteristics of the installation concerned, its geographical location and the local environmental conditions. In all circumstances, the conditions of the permit must include provisions on the minimisation of long-distance or transboundary pollution and must ensure a high level of protection for the environment as a whole.

Member States have the obligation, according to Article 11 of the Directive, to ensure that competent authorities follow or are informed of developments in best available techniques.

### **3. Objective of this Document**

Article 16(2) of the Directive requires the Commission to organise “an exchange of information between Member States and the industries concerned on best available techniques, associated monitoring and developments in them”, and to publish the results of the exchange.

The purpose of the information exchange is given in recital 25 of the Directive, which states that “the development and exchange of information at Community level about best available techniques will help to redress the technological imbalances in the Community, will promote the worldwide dissemination of limit values and techniques used in the Community and will help the Member States in the efficient implementation of this Directive.”

The Commission (Environment DG) established an information exchange forum (IEF) to assist the work under Article 16(2) and a number of technical working groups have been established under the umbrella of the IEF. Both IEF and the technical working groups include representation from Member States and industry as required in Article 16(2).

The aim of this series of documents is to reflect accurately the exchange of information which has taken place as required by Article 16(2) and to provide reference information for the permitting authority to take into account when determining permit conditions. By providing relevant information concerning best available techniques, these documents should act as valuable tools to drive environmental performance.

### **4. Information Sources**

This document represents a summary of information collected from a number of sources, including in particular the expertise of the groups established to assist the Commission in its work, and verified by the Commission services. All contributions are gratefully acknowledged.

### **5. How to understand and use this document**

The information provided in this document is intended to be used as an input to the determination of BAT in specific cases. When determining BAT and setting BAT-based permit conditions, account should always be taken of the overall goal to achieve a high level of protection for the environment as a whole.

Chapters 1 and 2 provide general information on the industrial sector concerned and on the industrial processes used within the sector.

Chapter 3 provides data and information concerning current emission and consumption levels, reflecting the situation in existing installations at the time of writing.

Chapter 4 describes in more detail the emission reduction and other techniques that are considered to be most relevant for determining BAT and BAT-based permit conditions. This information includes the consumption and emission levels considered achievable by using the technique, some idea of the costs and the cross-media issues associated with the technique, and the extent to which the technique is applicable to the range of installations requiring IPPC permits, for example new, existing, large or small installations. Techniques that are generally seen as obsolete are not included.

Chapter 5 presents the techniques and the emission and consumption levels that are considered to be compatible with BAT in a general sense. The purpose is thus to provide general indications regarding the emission and consumption levels that can be considered as an appropriate reference point to assist in the determination of BAT-based permit conditions or for the establishment of general binding rules under Article 9(8). It should be stressed, however, that this document does not propose emission limit values. The determination of appropriate permit conditions will involve taking account of local, site-specific factors such as the technical characteristics of the installation concerned, its geographical location and the local environmental conditions. In the case of existing installations, the economic and technical viability of upgrading them also needs to be taken into account. Even the single objective of ensuring a high level of protection for the environment as a whole will often involve making trade-off judgements between different types of environmental impact, and these judgements will often be influenced by local considerations.

Although an attempt is made to address some of these issues, it is not possible for them to be considered fully in this document. The techniques and levels presented in the (BAT) chapter(s) to be added will therefore not necessarily be appropriate for all installations. On the other hand, the obligation to ensure a high level of environmental protection including the minimisation of long-distance or transboundary pollution implies that permit conditions cannot be set on the basis of purely local considerations. It is therefore of the utmost importance that the information contained in this document is fully taken into account by permitting authorities.

Since the best available techniques change over time, this document will be reviewed and updated as appropriate. All comments and suggestions should be made to the European IPPC Bureau at the Institute for Prospective Technological Studies at the following address:

Edificio Expo, c/Inca Garcilaso, s/n, E-41092 Seville, Spain  
Telephone: +34 95 4488 284  
Fax: +34 95 4488 426  
e-mail: [jrc-ipts-eippcb@ec.europa.eu](mailto:jrc-ipts-eippcb@ec.europa.eu)  
Internet: <http://eippcb.jrc.es>

## 6. Interface between the IPPC and the Waste Incineration Directives

The following presentation of the issues is related to the interface between Directive 2000/76/EC of 4 December 2000 on the incineration of waste (WI Directive) and Directive 96/61/EC of 24 September 1996 concerning integrated pollution prevention and control (IPPC Directive).

It should be noted that the ultimate interpretation of Community law is a matter for the European Court of Justice and therefore it cannot be excluded that interpretation by the Court may raise new issues in the future.

The WI Directive contains, among others, the following explicit reference to the IPPC Directive:

Recital 13 of the WI Directive states that “*Compliance with the emission limit values laid down by this Directive should be regarded as a necessary but not sufficient condition for compliance with the requirements of Directive 96/61/EC. Such compliance may involve more stringent emission limit values for the pollutants envisaged by this Directive, emission limit values for other substances and other media, and other appropriate conditions.*”

The recital makes clear that compliance with the emissions limit values laid down in the WI Directive does not remove the obligation to operate in compliance with all the provisions of the IPPC Directive, including a permit containing emission limit values or equivalent parameters and technical measures determined according to the provisions of Article 9(4) or Article 9(8) of the latter. As presented in the standard BREF preface, a certain flexibility is anchored in the provisions of Article 9(4) of the IPPC Directive as well as in the definition of BAT. However, if stricter conditions, compared to the conditions of the WI Directive, are determined by a competent authority or through general binding rules to be necessary to fulfil the requirements of the IPPC Directive for a particular permit, these stricter conditions shall apply.



---

# Best Available Techniques Reference Document on Waste Incineration

<b>EXECUTIVE SUMMARY</b> .....	<b>I</b>
<b>PREFACE</b> .....	<b>XI</b>
<b>SCOPE</b> .....	<b>XXXIII</b>
<b>1 GENERAL INFORMATION ON WASTE INCINERATION</b> .....	<b>1</b>
1.1 Purpose of incineration and basic theory .....	1
1.2 Overview of waste incineration in Europe .....	2
1.3 Plant sizes .....	5
1.4 Overview of legislation .....	6
1.5 Waste composition and process design .....	6
1.6 Key environmental issues .....	9
1.6.1 Process emissions to air and water .....	9
1.6.2 Installation residues production .....	10
1.6.3 Process noise and vibration .....	11
1.6.4 Energy production and consumption .....	12
1.6.5 Consumption of raw materials and energy by the installation .....	13
1.7 Economic information .....	13
<b>2 APPLIED TECHNIQUES</b> .....	<b>19</b>
2.1 Overview and introduction .....	19
2.2 Pretreatment, storage and handling techniques .....	20
2.2.1 Municipal solid wastes (MSW) .....	21
2.2.1.1 Collection and pretreatment outside the MSW incineration plant .....	21
2.2.1.2 Municipal solid waste pretreatment within the incineration plant .....	22
2.2.1.3 Waste delivery and storage .....	22
2.2.1.3.1 Waste control .....	22
2.2.1.3.2 Bunker .....	22
2.2.2 Hazardous wastes .....	23
2.2.2.1 Brief description of the sector .....	23
2.2.2.2 Waste acceptance .....	24
2.2.2.3 Storage .....	25
2.2.2.3.1 Storage of solid hazardous waste .....	26
2.2.2.3.2 Storage of pumpable hazardous waste .....	26
2.2.2.3.3 Storage for containers and tank containers .....	27
2.2.2.4 Feeding and pretreatment .....	27
2.2.3 Sewage sludge .....	28
2.2.3.1 Composition of sewage sludge .....	28
2.2.3.2 Pretreatment of sewage sludge .....	29
2.2.3.2.1 Physical dewatering .....	29
2.2.3.2.2 Drying .....	30
2.2.3.2.3 Sludge digestion .....	31
2.2.4 Clinical waste .....	31
2.2.4.1 Nature and composition of clinical wastes .....	31
2.2.4.2 Handling, pretreatment and storage of clinical waste .....	32
2.3 The thermal treatment stage .....	32
2.3.1 Grate incinerators .....	35
2.3.1.1 Waste feeder .....	36
2.3.1.2 Incineration grate .....	36
2.3.1.2.1 Rocking grates .....	37
2.3.1.2.2 Reciprocating grates .....	37
2.3.1.2.3 Travelling grates .....	38
2.3.1.2.4 Roller grates .....	38
2.3.1.2.5 Cooled grates .....	38
2.3.1.3 Bottom ash discharger .....	38
2.3.1.4 Incineration chamber and boiler .....	39
2.3.1.5 Incineration air feeding .....	41
2.3.1.6 Auxiliary burner .....	42
2.3.1.7 Incineration temperature, residence time, minimum oxygen content .....	42

2.3.1.8	Sewage sludge incineration in MSWI plants .....	42
2.3.1.9	Addition of clinical waste to a municipal waste incinerator .....	43
2.3.2	Rotary kilns .....	44
2.3.2.1	Kilns and post combustion chambers for hazardous waste incineration .....	45
2.3.2.2	Drum kiln with post-combustion chamber for hazardous waste incineration .....	45
2.3.3	Fluidised beds.....	47
2.3.3.1	Stationary (or bubbling) fluidised bed incineration .....	49
2.3.3.2	Circulating fluidised bed (CFB) for sewage sludge .....	51
2.3.3.3	Spreader-stoker furnace .....	51
2.3.3.4	Rotating fluidised bed.....	52
2.3.4	Pyrolysis and gasification systems .....	52
2.3.4.1	Introduction to gasification and pyrolysis.....	52
2.3.4.2	Gasification.....	53
2.3.4.2.1	Examples of gasification processes .....	55
2.3.4.3	Pyrolysis .....	56
2.3.4.3.1	Example of a pyrolysis process .....	58
2.3.4.3.2	Example of pyrolysis in combination with a power plant .....	59
2.3.4.4	Combination processes .....	61
2.3.4.4.1	Pyrolysis – incineration .....	61
2.3.4.4.2	Pyrolysis – gasification.....	64
2.3.4.4.3	Gasification – combustion .....	66
2.3.5	Other techniques.....	67
2.3.5.1	Stepped and static hearth furnaces.....	67
2.3.5.2	Multiple hearth furnaces .....	67
2.3.5.3	Multiple hearth fluidised bed furnace .....	70
2.3.5.4	Modular systems .....	70
2.3.5.5	Incineration chambers for liquid and gaseous wastes .....	71
2.3.5.6	Cycloid incineration chamber for sewage sludge .....	72
2.3.5.7	Example of process for the incineration of liquid and gaseous chlorinated wastes with HCl recovery.....	72
2.3.5.8	Example of a process for the incineration of highly chlorinated liquid wastes with chlorine recycling .....	74
2.3.5.9	Waste water incineration .....	75
2.3.5.10	Plasma technologies.....	77
2.3.5.11	Various techniques for sewage sludge incineration .....	79
2.4	The energy recovery stage .....	81
2.4.1	Introduction and general principles .....	81
2.4.2	External factors affecting energy efficiency.....	82
2.4.2.1	Waste type and nature.....	82
2.4.2.2	Influence of plant location on energy recovery .....	84
2.4.2.3	Factors taken into account when selecting the design of the energy cycle .....	86
2.4.3	Energy efficiency of waste incinerators .....	87
2.4.3.1	Energy inputs to waste incinerators .....	87
2.4.3.2	Energy outputs from waste incinerators .....	88
2.4.4	Applied techniques for improving energy recovery .....	88
2.4.4.1	Waste feed pretreatment .....	88
2.4.4.2	Boilers and heat transfer .....	89
2.4.4.2.1	Corrosion in boilers .....	91
2.4.4.3	Combustion air preheating.....	93
2.4.4.4	Water cooled grates .....	93
2.4.4.5	Flue-gas condensation .....	93
2.4.4.6	Heat pumps .....	95
2.4.4.6.1	Compressor driven heat pumps .....	95
2.4.4.6.2	Absorption heat pumps.....	96
2.4.4.6.3	Open heat pumps .....	96
2.4.4.6.4	Example data of different heat pumps .....	96
2.4.4.7	Flue-gas re-circulation.....	97
2.4.4.8	Reheating of flue-gases to the operation temperature FGT devices .....	97
2.4.4.9	Plume visibility reduction.....	97
2.4.4.10	Steam-water cycle improvements: effect on efficiency and other aspects.....	97
2.4.5	Steam generators and quench cooling for hazardous waste incinerators.....	98
2.4.6	Examples of energy recovery from fluidised bed incinerators .....	99
2.5	Applied flue-gas treatment and control systems .....	100

2.5.1	Summary of the application of FGT techniques .....	100
2.5.2	Overview of overall combined FGT system options .....	102
2.5.3	Techniques for reducing particulate emissions .....	102
2.5.3.1	Electrostatic precipitators .....	103
2.5.3.2	Wet electrostatic precipitators .....	103
2.5.3.3	Condensation electrostatic precipitators .....	104
2.5.3.4	Ionisation wet scrubbers .....	105
2.5.3.5	Fabric filters .....	105
2.5.3.6	Cyclones and multi-cyclones .....	106
2.5.4	Techniques for the reduction of acid gases (e.g. HCl, HF and SO <sub>x</sub> emissions) .....	107
2.5.4.1	Removal of sulphur dioxide and halogens .....	107
2.5.4.2	Direct desulphurisation .....	110
2.5.5	Techniques for the reduction of emissions of oxides of nitrogen .....	111
2.5.5.1	Primary techniques for NO <sub>x</sub> reduction .....	111
2.5.5.1.1	Air supply, gas mixing and temperature control .....	111
2.5.5.1.2	Flue-Gas Recirculation (FGR) .....	112
2.5.5.1.3	Oxygen injection .....	112
2.5.5.1.4	Staged combustion .....	112
2.5.5.1.5	Natural gas injection (re-burn) .....	112
2.5.5.1.6	Injection of water into furnace/flame .....	112
2.5.5.2	Secondary techniques for NO <sub>x</sub> reduction .....	112
2.5.5.2.1	Selective Non-Catalytic Reduction (SNCR) process .....	113
2.5.5.2.2	Selective Catalytic Reduction (SCR) process .....	115
2.5.6	Techniques for the reduction of mercury emissions .....	116
2.5.6.1	Primary techniques .....	116
2.5.6.2	Secondary techniques .....	116
2.5.7	Techniques for the reduction of other emissions of heavy metals .....	117
2.5.8	Techniques for the reduction of emissions of organic carbon compounds .....	117
2.5.8.1	Adsorption on activated carbon reagents in an entrained flow system .....	118
2.5.8.2	SCR systems .....	118
2.5.8.3	Catalytic bag filters .....	118
2.5.8.4	Re-burn of carbon adsorbents .....	119
2.5.8.5	Use of carbon impregnated plastics for PCDD/F adsorption .....	119
2.5.8.6	Static bed filters .....	120
2.5.8.7	Rapid quenching of flue-gases .....	120
2.5.9	Reduction of greenhouse gases (CO <sub>2</sub> , N <sub>2</sub> O) .....	121
2.5.9.1	Prevention of nitrous oxide emissions .....	121
2.5.10	Overview of flue-gas treatments applied at hazardous waste incinerators .....	121
2.5.11	Flue-gas treatment for sludge incinerators .....	122
2.6	Waste water treatment and control techniques .....	123
2.6.1	Potential sources of waste water .....	123
2.6.2	Basic design principles for waste water control .....	124
2.6.3	Influence of flue-gas treatment systems on waste water .....	125
2.6.4	Processing of waste water from wet flue-gas treatment systems .....	126
2.6.4.1	Physico-chemical treatment .....	126
2.6.4.2	Application of sulphides .....	127
2.6.4.3	Application of membrane technology .....	128
2.6.4.4	Stripping of ammonia .....	128
2.6.4.5	Separate treatment of waste water from the first and the last steps of the scrubber system .....	128
2.6.4.6	Anaerobic biological treatment (conversion of sulphates into elementary sulphur) .....	129
2.6.4.7	Evaporation systems for process waste water .....	129
2.6.4.7.1	In-line evaporation .....	129
2.6.4.7.2	Separate evaporation .....	130
2.6.4.8	Example of process producing hydrochloric acid with downstream cleaning .....	131
2.6.5	Waste water treatment at hazardous waste incinerators .....	131
2.7	Solid residue treatment and control techniques .....	133
2.7.1	Types of solid residues .....	133
2.7.2	Treatment and re-cycling of solid residues .....	135
2.7.3	Treatments applied to Flue-gas treatment residues .....	136
2.7.3.1	Solidification and chemical stabilisation of FGT residues .....	136
2.7.3.2	Thermal treatment of FGT residues .....	136
2.7.3.3	Extraction and separation of FGT residues .....	137

2.7.3.4	Chemical stabilisation of FGT residues .....	138
2.7.3.5	Other methods or practices for FGT residues .....	138
2.8	Monitoring and control techniques .....	138
2.8.1	Incineration control systems .....	138
2.8.2	Overview of emissions monitoring carried out .....	139
2.8.3	Experiences with continuous sampling of dioxin emissions .....	140
2.8.4	Experiences with continuous measurement of mercury emissions .....	141
2.8.5	Overview of safety devices and measures .....	142
<b>3</b>	<b>EMISSIONS AND CONSUMPTIONS.....</b>	<b>143</b>
3.1	Introduction .....	143
3.1.1	Substance partitioning in waste incineration .....	144
3.1.2	Examples of the dioxin balance for MSWI .....	146
3.1.3	Composition of crude flue-gas in waste incineration plants .....	147
3.1.4	Emissions of gases relevant to climate change .....	149
3.2	Emissions to air .....	150
3.2.1	Substances emitted to air .....	150
3.2.2	Municipal waste incineration plants .....	156
3.2.2.1	Summary data for emissions to air from MSWI .....	156
3.2.2.2	European air emissions survey data for MSWI .....	157
3.2.2.3	Emissions to air from fluidised bed incinerators .....	162
3.2.3	Hazardous waste incineration plants .....	162
3.2.3.1	Summary data of the emissions to air from HWI .....	162
3.2.3.2	European air emissions survey data for HWI .....	163
3.3	Emissions to water .....	174
3.3.1	Volumes of waste water arising from flue-gas treatment .....	174
3.3.2	Other potential sources of waste water from waste incineration plants .....	175
3.3.3	Installations free of process water releases .....	175
3.3.4	Plants with physico-chemical waste water treatment .....	175
3.3.5	Hazardous waste incineration plants - European survey data .....	179
3.3.5.1	General overview of emissions to water from European HWI .....	179
3.3.5.2	Overview by parameter of emissions to water from European HWI .....	180
3.4	Solid residues .....	186
3.4.1	Mass streams of solid residues in MSWI .....	186
3.4.2	Bottom ash composition and leachability .....	187
3.5	Energy consumption and production .....	192
3.5.1	Energy efficiency calculation for waste incineration installations .....	193
3.5.2	Waste net calorific value calculation .....	193
3.5.3	Equivalence factors .....	194
3.5.4	Data on the recovery of energy from waste .....	194
3.5.4.1	Electricity recovery data .....	195
3.5.4.2	Heat recovery data .....	196
3.5.4.3	Combined heat and power data .....	197
3.5.4.4	Boiler conversion efficiency data .....	197
3.5.5	Data on the consumption of energy by the process .....	198
3.5.6	Data comparing energy required by, and output from, the installation .....	199
3.6	Noise .....	201
3.7	Other operating resources .....	202
3.7.1	Water .....	202
3.7.2	Other operating resources .....	203
3.7.2.1	Neutralisers .....	203
3.7.2.2	NO <sub>x</sub> removal agents .....	203
3.7.2.3	Fuel oil and natural gas .....	204
3.7.2.4	Merchant hazardous waste incinerator plant survey data .....	204
<b>4</b>	<b>TECHNIQUES TO CONSIDER IN THE DETERMINATION OF BAT .....</b>	<b>205</b>
4.1	General practices applied before the thermal treatment stage .....	207
4.1.1	Suitability of process design for the waste(s) received .....	207
4.1.2	General housekeeping measures .....	208
4.1.3	Quality control of incoming wastes .....	208
4.1.3.1	Establishing installation input limitations and identifying key risks .....	208
4.1.3.2	Communication with waste suppliers to improve incoming waste quality control .....	210
4.1.3.3	Controlling waste feed quality on the incinerator site .....	211
4.1.3.4	Checking, sampling and testing incoming wastes .....	212

4.1.3.5	Detectors for radioactive materials.....	214
4.1.4	Waste storage.....	215
4.1.4.1	Sealed surfaces, controlled drainage and weatherproofing .....	215
4.1.4.2	Management of storage times.....	217
4.1.4.3	Baling or other containment of solid waste.....	218
4.1.4.4	Extraction of incineration air from storage areas for odour, dust and fugitive release control .....	219
4.1.4.5	Segregation of waste types for safe processing.....	221
4.1.4.6	Individual labelling of contained waste loads .....	222
4.1.4.7	The use of fire detection and control systems .....	223
4.1.5	Pretreatment of incoming waste.....	224
4.1.5.1	Pretreatment and mixing of wastes .....	224
4.1.5.2	Shredding of mixed municipal wastes.....	227
4.1.5.3	Shredding of drummed and packaged hazardous wastes .....	228
4.1.5.4	Feed equalising control system for solid hazardous wastes .....	229
4.1.5.5	Pre-combustion removal of recyclable metals.....	231
4.1.5.6	Pretreatment and targeted preparation of solid waste for combustion.....	232
4.1.6	Waste transfer and loading.....	233
4.1.6.1	Positioning and view of operator.....	233
4.1.6.2	Provision of storage space for items removed from the waste .....	233
4.1.6.3	Direct injection of liquid and gaseous hazardous wastes in rotary kilns .....	233
4.1.6.4	Reduction of air ingress into the combustion chamber during loading .....	234
4.2	Thermal processing.....	235
4.2.1	Combustion technology selection .....	235
4.2.2	Use of flow modelling .....	240
4.2.3	Combustion chamber design features .....	241
4.2.4	Design to increase turbulence in the secondary combustion chamber .....	243
4.2.5	Use of continuous rather than batch operation.....	244
4.2.6	Selection and use of suitable combustion control systems and parameters .....	245
4.2.7	Use of infrared cameras for combustion monitoring and control .....	247
4.2.8	Optimisation of air supply stoichiometry.....	249
4.2.9	Primary air supply optimisation and distribution.....	250
4.2.10	Preheating of primary and secondary air .....	252
4.2.11	Secondary air injection, optimisation and distribution.....	253
4.2.12	Replacement of part of the secondary air with re-circulated flue-gas.....	254
4.2.13	Application of oxygen enriched air.....	256
4.2.14	Cooling of grates.....	258
4.2.15	Water cooling of rotary kilns .....	260
4.2.16	Higher temperature incineration (slagging) .....	261
4.2.17	Increased agitation and residence time of the waste in the furnace .....	263
4.2.18	Adjustment of throughput to maintain good burnout and combustion conditions .....	265
4.2.19	Optimisation of time, temperature, turbulence of gases in the combustion zone, and oxygen concentrations .....	266
4.2.20	Use of automatically operated auxiliary burners .....	269
4.2.21	Reduction of grate riddling rate and/or return of cooled riddlings to the combustion chamber.....	270
4.2.22	Protection of furnace membrane walls and boiler first pass with refractory or other materials.....	272
4.2.23	Use of low gas velocities in the furnace and the inclusion of empty passes before the boiler convection section .....	274
4.2.24	Determination of calorific value of the waste and its use as a combustion control parameter .....	275
4.2.25	Low-NO <sub>x</sub> burners for liquid wastes.....	276
4.2.26	Fluidised bed gasification .....	276
4.2.27	High temperature combustion of gasification syngas with ash melting.....	279
4.3	Energy recovery .....	281
4.3.1	Optimisation of overall energy efficiency and energy recovery .....	281
4.3.2	Energy loss reduction: flue-gas losses .....	288
4.3.3	Increasing burnout of the waste .....	290
4.3.4	Reducing excess air volumes .....	290
4.3.5	Other energy loss reduction measures .....	291
4.3.6	Reduction of overall process energy consumption .....	292
4.3.7	Selection of turbine.....	294

4.3.8	Increased steam parameters and application of special materials to decrease corrosion in boilers.....	296
4.3.9	Reduction of condenser pressure (i.e. improve vacuum).....	299
4.3.10	Selection of cooling system.....	301
4.3.11	Optimisation of boiler architecture.....	302
4.3.12	Use of an integral furnace - boiler.....	304
4.3.13	Use of water walls in the first (empty) pass.....	305
4.3.14	Use of a platten type superheater.....	305
4.3.15	Reduction of flue-gas temperatures after the boiler.....	306
4.3.16	Use of flue-gas condensation scrubbers.....	308
4.3.17	Use of heat pumps to increase heat recovery.....	309
4.3.18	Special configurations of the water/steam cycle with external power plants.....	311
4.3.19	Efficient cleaning of the convection bundles.....	313
4.4	Flue-gas treatment.....	315
4.4.1	Factors to consider when selecting flue-gas treatment systems.....	315
4.4.1.1	General factors.....	315
4.4.1.2	Energy optimisation.....	316
4.4.1.3	Overall optimisation and the “whole system” approach.....	316
4.4.1.4	Technique selection for existing or new installations.....	316
4.4.2	Reduction of dust emissions.....	317
4.4.2.1	Application of a pre-dedusting stage before other flue-gas treatments.....	317
4.4.2.2	Application of an additional flue-gas polishing system.....	321
4.4.2.3	Application of double bag filtration.....	324
4.4.2.4	Selection of bag filter materials.....	326
4.4.3	Reduction of acid gas emissions.....	328
4.4.3.1	Wet scrubbing systems.....	328
4.4.3.2	Semi-wet scrubbing systems.....	332
4.4.3.3	Intermediate systems with some water addition and residue recirculation (flash dry systems).....	336
4.4.3.4	Dry FGT systems.....	339
4.4.3.5	Selection of alkaline reagent.....	342
4.4.3.6	Addition of wet scrubbing as a flue-gas polishing system after other FGT processes.....	344
4.4.3.7	Recirculation of FGT residues in the FGT system.....	345
4.4.3.8	Direct addition of alkaline reagents to the waste (direct desulphurisation).....	347
4.4.3.9	Use of acid gas monitoring for FGT process optimisation.....	348
4.4.4	Reduction in the emissions of nitrogen oxides.....	349
4.4.4.1	Selective catalytic reduction (SCR).....	349
4.4.4.2	Selective non-catalytic reduction (SNCR).....	355
4.4.4.3	Optimisation of reagent selection for SNCR NO <sub>x</sub> reduction.....	359
4.4.4.4	Replacement of secondary air with re-circulated flue-gas.....	360
4.4.5	Reduction of PCDD/F emissions.....	360
4.4.5.1	Primary techniques for prevention of PCDD/F.....	361
4.4.5.2	Prevention of reformation of PCDD/F in the FGT system.....	361
4.4.5.3	Destruction of PCDD/F using Selective Catalytic Reduction (SCR).....	363
4.4.5.4	Destruction of PCDD/F using catalytic filter bags.....	365
4.4.5.5	Destruction of PCDD/F by re-burn of adsorbents.....	367
4.4.5.6	Adsorption of PCDD/F by activated carbon injection or other reagents.....	368
4.4.5.7	Adsorption of PCDD/F in static beds.....	369
4.4.5.8	Use of carbon impregnated materials for PCDD/F adsorption in wet scrubbers.....	372
4.4.5.9	Use of carbon slurries in wet scrubbers.....	373
4.4.6	Reduction of mercury emissions.....	374
4.4.6.1	Low pH wet scrubbing and additive addition.....	374
4.4.6.2	Activated carbon injection for Hg adsorption.....	376
4.4.6.3	Use of condensing scrubbers for flue-gas polishing.....	378
4.4.6.4	Separation of mercury using a resin filter.....	380
4.4.6.5	Chlorite injection for elemental Hg control.....	380
4.4.6.6	Addition of hydrogen peroxide to wet scrubbers.....	381
4.4.6.7	Use of static activated carbon or coke filters.....	382
4.4.7	Other techniques and substances.....	382
4.4.7.1	Use of specific reagents for iodine and bromine reduction.....	382
4.5	Waste water treatment and control.....	384
4.5.1	General.....	384

4.5.2	Application of optimal incineration technology .....	384
4.5.3	Application of waste water free gas cleaning technology.....	384
4.5.4	Re-circulation of polluted waste water in wet gas cleaning systems .....	386
4.5.5	Additional cooling of feed water of wet gas cleaning systems .....	386
4.5.6	Use of boiler drain water as a water supply for scrubbers .....	387
4.5.7	Treatment of laboratory waste water in the scrubber.....	387
4.5.8	Re-circulation of effluents to the process in place of their discharge .....	388
4.5.9	Separate discharge of rainwater from roofs and other clean surfaces .....	389
4.5.10	Provision of storage/buffering capacity for waste water.....	390
4.5.11	Application of physico-chemical treatment to wet scrubber effluents and other contaminated waste water from the plant.....	391
4.5.12	Ammonia removal from effluents.....	392
4.5.13	Separate treatment of effluents arising from different wet scrubbing stages .....	393
4.5.14	Evaporation of wet scrubber effluent in the incineration process .....	394
4.5.15	Separate evaporation of wet scrubber effluent.....	394
4.5.16	Recovery of hydrochloric acid from wet scrubber effluents .....	394
4.5.17	Recovery of gypsum from wet scrubber effluent.....	395
4.6	Treatment techniques for solid residues.....	397
4.6.1	Improving the burnout of bottom ash .....	397
4.6.2	Segregation of the bottom ash from flue-gas treatment residues .....	399
4.6.3	Separation of the dust removal stage from other flue-gas treatments .....	400
4.6.4	Bottom ash - separation of metals.....	401
4.6.5	Bottom ash screening and crushing .....	402
4.6.6	Bottom ash treatment using ageing .....	403
4.6.7	Bottom ash treatment using dry treatment systems.....	405
4.6.8	Bottom ash treatment using wet treatment systems .....	408
4.6.9	Bottom ash treatment using thermal systems.....	410
4.6.10	High temperature (slagging) rotary kiln.....	412
4.6.11	FGT residue treatments.....	412
4.6.11.1	Cement solidification of FGT residues.....	412
4.6.11.2	Vitrification and melting of FGT residues .....	414
4.6.11.3	Acid extraction of boiler and fly ash.....	417
4.6.11.4	Treatment of FGT residues arising from dry sodium bicarbonate FGT process for use in the soda ash industry .....	418
4.6.11.5	Treatment of FGT residues arising from dry sodium bicarbonate FGT process using hydraulic binders .....	420
4.7	Noise .....	421
4.8	Environmental management tools.....	422
4.9	Good practice for public awareness and communication.....	429
<b>5</b>	<b>BEST AVAILABLE TECHNIQUES.....</b>	<b>431</b>
5.1	Generic BAT for all waste incineration .....	434
5.2	Specific BAT for municipal waste incineration .....	450
5.3	Specific BAT for pretreated or selected municipal waste incineration .....	451
5.4	Specific BAT for hazardous waste incineration.....	452
5.5	Specific BAT for sewage sludge incineration .....	453
5.6	Specific BAT for clinical waste incineration .....	453
<b>6</b>	<b>EMERGING TECHNIQUES.....</b>	<b>455</b>
6.1	Use of steam as a spraying agent in post combustion chamber burners instead of air .....	455
6.2	Application involving the reheating of turbine steam .....	455
6.3	Other measures in the crude flue-gas area for reducing dioxin emissions .....	456
6.4	Oil scrubber for the reduction of polyhalogenated aromatics and polyaromatic hydrocarbons (PAHs) in the flue-gases from incineration plants .....	456
6.5	Use of CO <sub>2</sub> in flue-gases for the production of sodium carbonate .....	457
6.6	Increased bed temperature, combustion control and oxygen addition in a grate incinerator.....	458
6.7	The PECK combination process for MSW treatment .....	459
6.8	FeSO <sub>4</sub> stabilisation of FGT residues .....	463
6.9	CO <sub>2</sub> stabilisation of FGT residues.....	464
6.10	Overview of some other emerging FGT residue treatment techniques .....	465
6.11	Application of membrane technology for use in waste water treatment plants for wet scrubber effluents.....	466
6.12	Combined dry sodium bicarbonate + SCR + scrubber FGT systems .....	466

<b>7</b>	<b>CONCLUDING REMARKS.....</b>	<b>471</b>
7.1	Timing of the work .....	471
7.2	Sources of information and information gaps.....	471
7.3	Degree of Consensus reached.....	474
7.4	Other specific notes and issues .....	474
7.4.1	Existence of installations with operational emission levels below those concluded as BAT .....	474
7.4.2	Comprehensiveness of Table 5.3 on selection criteria for FGT systems (BAT 37) .....	474
7.4.3	Use of dry FGT systems at certain hazardous waste incinerators (BAT75).....	475
7.4.4	Impacts of energy pricing and policies on energy efficiency .....	475
7.4.5	Competition and regulatory impacts across waste treating industrial sectors .....	475
7.4.6	Development and implementation of waste strategies .....	476
7.4.7	Markets and standards for bottom ash and other residues .....	476
7.4.8	Co-ordinated education and demonstration of health/environmental impacts.....	477
7.5	Suggested topics for future R&D projects.....	477
<b>8</b>	<b>REFERENCES.....</b>	<b>479</b>
<b>9</b>	<b>GLOSSARY .....</b>	<b>483</b>
<b>10</b>	<b>ANNEXES.....</b>	<b>489</b>
10.1	Economic overview of MSWI - Member State information.....	489
10.2	Economic overview – some technological aspects of MSWI.....	503
10.2.1	Discharge and storage costs for MSWI.....	505
10.2.2	Firing system and boiler costs for MSWI.....	506
10.2.3	Water-steam cycle costs for MSWI.....	507
10.2.4	Costs for some flue-gas treatment combinations used in MSWI.....	513
10.2.4.1	Dry flue-gas cleaning.....	514
10.2.4.2	Absorption and adsorption plants for the separation of HCl, HF and SO <sub>2</sub> .....	516
10.2.4.3	NaOH scrubber .....	518
10.2.4.4	Secondary NO <sub>x</sub> reduction using SCR or SNCR .....	519
10.2.4.5	Post treatment flue-gas polishing systems .....	520
10.2.5	Cost estimations for some complete MSWI plants.....	521
10.2.6	Costs of fluidised bed combustion for MSW .....	526
10.2.7	Gasification and pyrolysis system costs for MSW .....	528
10.3	Example installation descriptions .....	530
10.3.1	Examples of municipal waste incineration.....	531
10.3.1.1	Grate incinerator with SCR and steam distribution .....	531
10.3.1.2	Grate incinerator with SCR and CHP .....	536
10.3.1.3	Grate incinerator with SCR, CHP and bottom ash treatment.....	542
10.3.1.4	Grate incinerator with SNCR de-NO <sub>x</sub> , combined double filtration and wet scrubbing .....	546
10.3.1.5	Grate incinerator with semi-wet FGT, active carbon injection, ash recirculation, bottom ash treatment and (mainly) electricity generation.....	549
10.3.1.6	Grate incinerator with SNCR de-NO <sub>x</sub> , semi-wet FGT, active carbon injection and high steam parameters (60 bar/380 °C) electricity generation.....	550
10.3.1.7	Grate incinerator with SNCR (NH <sub>3</sub> ), semi-wet lime, active carbon and electricity generation .....	551
10.3.1.8	Grate incinerator with SNCR (NH <sub>3</sub> ), semi-wet lime, active carbon and electricity generation .....	552
10.3.2	Examples of the hazardous wastes installations .....	554
10.3.2.1	Rotary kiln with heat recovery, SNCR, EP, wet scrubber and static coke filter .....	554
10.3.2.2	Rotary kiln with SCR, EP, wet scrubber and static carbon filter .....	559
10.3.2.3	Rotary kiln with SNCR (urea), dry lime FGT, double bag filtration and dioxin absorption .....	561
10.3.3	Examples of sewage sludge installations.....	562
10.3.3.1	Bubbling fluidised bed with heat recovery, SNCR, EP, wet scrubbing and static coke filter .....	562
10.3.3.2	Bubbling FB with CHP, SNCR, flue-gas re-circulation, EP, wet scrubbing and bag filters with coke/calcium carbonate injection .....	565
10.3.3.3	Bubbling FB Plant with CHP, EP and wet scrubbing.....	567
10.3.4	Examples of combined incineration of various wastes.....	568
10.3.4.1	Circulating FB for selected/pre-treated wastes with heat recovery, dry and wet FGT, SCR and ash treatment.....	568



---

10.3.4.2	Fluidized bed plant for selected hazardous and non-hazardous wastes with heat recovery, EP, fabric filter, wet scrubber and SCR.....	573
10.3.4.3	Water cooled grate furnace with CHP, cyclone de-dusting, SNCR and high dust SCR de-NO <sub>x</sub> , and dry fabric filter.....	577
10.3.4.4	Grate incinerator treating MSW, SS & CW with SNCR (urea), dry Na bicarbonate FGT, activated C injection and electricity generation.....	580
10.3.4.5	Grate incinerator treating MSW and industrial waste with EP, wet scrubbing, effluent evaporation, SCR and high pressure steam electricity generation.....	582
10.3.4.6	Grate incinerator treating MW, IW, SS and waste sorting refuse with SNCR, EP, wet scrubbing (on-line evaporation of effluent), bag filters and CHP.....	583
10.3.4.7	Grate incinerator treating MSW, industrial and commercial waste with SNCR and semi-wet FGT and 20 bar 260 °C to district heating network.....	585
10.3.4.8	Grate incinerator treating MSW, IW and clinical waste with SNCR, dry FGT and electricity generation.....	587
10.3.4.9	Grate incinerator treating MSW, waste sorting residues and sludges with SNCR, dry FGT and heat supply to DH and local electricity plant.....	588
10.4	Energy calculation methodology and example calculation.....	590
10.4.1	General explanations of terms and system boundary of the energy calculation.....	590
10.4.2	Example of NCV calculation used by energy sub-group.....	591
10.4.3	Basic operational data for three examples of the energy calculation.....	592
10.4.4	Energy calculation formulas with basic operational data for three examples of the energy calculation.....	595
10.4.5	Equations to calculate the plant efficiency (Pl ef).....	599
10.5	Example of a multi-criteria assessment used for the selection of FGT systems.....	601

---

## List of figures

Figure 1.1: Municipal waste incineration capacity per capita.....	5
Figure 1.2: Bottom ash recycled and deposited from MSWI in 1999.....	11
Figure 1.3: Energy production by municipal waste incinerators in Europe (1999) .....	12
Figure 2.1: Example layout of a municipal solid waste incineration plant .....	19
Figure 2.2: Example of some hazardous waste pretreatment systems used at some merchant HWI.....	28
Figure 2.3: Grate, furnace and heat recovery stages of an example municipal waste incineration plant.....	35
Figure 2.4: Different grate types.....	37
Figure 2.5: Example of a type of ash remover used at a grate incinerator .....	39
Figure 2.6: Example of an incineration chamber .....	40
Figure 2.7: Various furnace designs with differing direction of the flue-gas and waste flow .....	41
Figure 2.8: Examples of the stages of a clinical waste loading systems used at a municipal waste incinerator .....	43
Figure 2.9: Schematic of a rotary kiln incineration system .....	44
Figure 2.10: Drum-type kiln with post-combustion chamber .....	45
Figure 2.11: Example of a drum-type kiln plant for hazardous waste incineration .....	47
Figure 2.12: Schematic diagram showing pretreatment of MSW prior to fluidised bed combustion .....	48
Figure 2.13: Main components of a stationary/bubbling fluidised bed.....	49
Figure 2.14: Main components of a circulating fluidised bed.....	51
Figure 2.15: Representation of a packed bed and current flow gasifier.....	54
Figure 2.16: Slag bath gasifier.....	55
Figure 2.17: Fluidised bed gasifier with high temperature slagging furnace.....	56
Figure 2.18: Structure of a pyrolysis plant for municipal waste treatment .....	57
Figure 2.19: Process scheme of ATM's 'pyrolysis'-unit .....	59
Figure 2.20: Energy balance and weight assessment of the ConTherm plant.....	60
Figure 2.21: Pyrolysis on a grate with directly connected high-temperature incineration.....	62
Figure 2.22: The RCP process .....	62
Figure 2.23: Example of a clinical waste pyrolysis-incineration plant, ZAVIN, Netherlands.....	64
Figure 2.24: Schematic diagram of a push pyrolyser (example shown operated by Thermostelect).....	65
Figure 2.25: Combined fluidised bed gasification and high temperature combustion process.....	66
Figure 2.26: Principle function of a multiple hearth furnace .....	68
Figure 2.27: Example of a sewage sludge incineration plant with a multiple hearth furnace.....	69
Figure 2.28: Principle function of a multiple hearth fluidised bed furnace .....	70
Figure 2.29: Principle of an incineration chamber for liquid and gaseous wastes .....	71
Figure 2.30: Illustration of a cycloid furnace.....	72
Figure 2.31: Diagram of a plant for HCl-extraction from residual gases and liquid halogenated wastes ..	73
Figure 2.32: Process scheme of a chlorine recycling unit operated by Akzo Nobel.....	75
Figure 2.33: Example of a waste water incinerator with a waste water evaporation (concentration) unit ..	76
Figure 2.34: Process scheme of a caustic water treatment plant operated by AVR.....	77
Figure 2.35: Graph showing recorded variation in waste NCV at a MSWI over 4 years .....	83
Figure 2.36: Illustration of individual heat surface areas in a steam generator.....	89
Figure 2.37: Basic boiler flow systems.....	90
Figure 2.38: Overview of various boiler systems: horizontal, combination, and, vertical.....	91
Figure 2.39: Pollution control and additional heat recovery by condensation of flue-gas water vapour at the Stockholm/Hogdalen waste-fired CHP plant .....	95
Figure 2.40: Overview of potential combinations of FGT systems .....	102
Figure 2.41: Operating principle of an electrostatic precipitator .....	103
Figure 2.42: Condensation electrostatic precipitator .....	104
Figure 2.43: An example of a fabric filter .....	106
Figure 2.44: Schematic diagram of a dry FGT system with reagent injection to the FG pipe and downstream bag filtration .....	108
Figure 2.45: Operating principle of a spray absorber .....	108
Figure 2.46: Diagram of a 2 stage wet scrubber with upstream de-dusting .....	110
Figure 2.47: Temperature dependence of various NO <sub>x</sub> formation mechanisms in waste incineration.....	111
Figure 2.48: SNCR operating principle .....	113
Figure 2.49: Relationship between NO <sub>x</sub> reduction, production, ammonia slip and reaction temperature for the SNCR process .....	114
Figure 2.50: SCR operating principle.....	115
Figure 2.51: Relationship between Hg emissions and the raw gas chloride content at a hazardous waste incineration plant.....	117
Figure 2.52: Process scheme for physico-chemical treatment of waste water from a wet flue-gas treatment system .....	126

Figure 2.53: In-line evaporation of waste water from wet scrubbing.....	129
Figure 2.54: Separate evaporation of scrubber effluent from wet scrubbing .....	130
Figure 2.55: Overview of applied waste water treatment systems at merchant HWIs .....	132
Figure 2.56: Example of a waste water treatment facility in the merchant HWI sector.....	133
Figure 3.1: Graph of NO <sub>x</sub> annual average emissions to air and applied abatement technique at European HWIs .....	165
Figure 3.2: Graph of annual average dust emissions to air and applied abatement technique at European HWIs .....	166
Figure 3.3: Graph of HCl annual average emissions to air and applied abatement technique at European HWIs .....	167
Figure 3.4: Graph of annual average sulphur dioxide emissions to air and applied abatement technique at European HWIs .....	168
Figure 3.5: Graph of Hg annual average emissions to air and applied abatement technique at European HWIs .....	170
Figure 3.6: Annual average emissions to air of other metals and applied abatement technique at European HWIs .....	171
Figure 3.7: Graph of Cd and Tl annual average emissions to air and applied abatement technique at European HWIs .....	172
Figure 3.8: Graph of PCDD/F annual average emissions to air and applied abatement technique at European HWIs .....	173
Figure 3.9: CO emission reductions achieved following introduction of pretreatment techniques at a hazardous waste incinerator.....	174
Figure 3.10: Graph of annual average suspended solid discharges to water and applied abatement technique at European HWIs .....	181
Figure 3.11: Graph of annual average mercury discharges to water and applied abatement technique at European HWIs .....	182
Figure 3.12: Graph of annual average discharges of various metals to water at European HWIs.....	183
Figure 3.13: Graph of annual average Arsenic discharges to water at European HWIs.....	183
Figure 3.14: Graph of annual average lead discharges to water at European HWIs .....	184
Figure 3.15: Graph of annual average Cadmium discharges to water at European HWIs .....	184
Figure 3.16: Graph of annual average Chromium discharges to water at European HWIs.....	184
Figure 3.17: Graph of annual average Copper discharges to water European HWIs .....	185
Figure 3.18: Graph of annual average Nickel discharges to water at European HWIs .....	185
Figure 3.19: Graph of annual average Zinc discharges to water at European HWIs.....	185
Figure 3.20: Graph showing increase in installation electrical consumption with increasing waste NCV .....	199
Figure 4.1: An example of the components of furnace control system .....	247
Figure 4.2: Basic components of a cyclonic high temperature syngas ash melting furnace.....	279
Figure 4.3: Schematic diagram of a “platen” type superheater .....	305
Figure 4.4: Combination of a waste incineration plant with a gas turbine power plant .....	312
Figure 4.5: Municipal waste incineration plant in combination with a coal power plant.....	312
Figure 4.6: Diagram showing typical design of a semi-wet FGT system.....	332
Figure 4.7: Diagram of an SCR system downstream of non-wet FGT showing typical heat exchange and temperature profiles.....	351
Figure 4.8: Diagram of an SCR system downstream of a wet FGT system showing additional heat exchange and temperature profiles .....	351
Figure 4.9: Effect of ageing on the leachability of selected metals: (left) effect on pH; (right) leaching as a function of pH .....	405
Figure 6.1: Example of the reheating of steam.....	455
Figure 6.2: Schematic of a waste incineration plant with a downstream oil scrubber for dioxin deposition .....	457
Figure 6.3: Basic components of the PECK process .....	459
Figure 6.4: Fly ash treatment in the PECK process.....	460
Figure 6.5: Bottom ash treatment in the PECK process .....	460
Figure 6.6: Comparison of metals partitioning between a conventional grate MSWI and the PECK process .....	461
Figure 6.7: Material flow mass balance for the PECK process.....	462
Figure 10.1: Water-steam cycle, option 1 .....	508
Figure 10.2: Water-steam cycle, option 2 and 6.....	509
Figure 10.3: Water-steam cycle, option 3 .....	510
Figure 10.4: Water-steam cycle, options 4, 5, 7 and 8.....	510
Figure 10.5: The impact of plant size and energy utilisation on the specific waste treatment costs of new MSWI installations.....	522

---

Figure 10.6: The impact of varying FGT systems and plant sizes on the treatment costs of new MSWI installations using the same energy utilisation techniques .....	522
Figure 10.7: Process flow scheme of the waste incineration plant Flötzersteig.....	531
Figure 10.8: Process flow scheme of the waste incineration plant Spittelau .....	537
Figure 10.9: Process flow scheme of the waste incineration plant Wels – line 1 .....	543
Figure 10.10: Process flow scheme of the rotary kilns of the Plant Simmeringer Haide.....	555
Figure 10.11: Process flow scheme of the fluidised bed reactors of the Plant Simmeringer Haide.....	562
Figure 10.12: Process flow scheme of AVE-Reststoffverwertung Lenzing .....	570
Figure 10.13: Process flow scheme of the Fluidised bed reactors at Arnoldstein.....	574
Figure 10.14: Summary of the energy system inputs and outputs used by BREF ESG.....	590

---

## List of tables

Table 1.1: Purpose of various components of a waste incinerator .....	2
Table 1.2: Amounts of municipal waste (MSW), hazardous waste (HW) and sewage sludge (SS) in EU-15 MSs, and their treatment.....	3
Table 1.3: Annual quantities of municipal and hazardous waste arising and the number of incineration plants in some Accession Countries .....	4
Table 1.4: Geographical distribution of incineration plants for municipal, hazardous and sewage sludge waste .....	4
Table 1.5: Average MSW incineration plant capacity by country .....	5
Table 1.6: Typical throughput ranges of thermal treatment technologies .....	6
Table 1.7: Typical composition of waste in Germany.....	8
Table 1.8: Gate fees in European MSW and HW incineration plants .....	14
Table 1.9: Comparative costs of MSW incineration in different MSs .....	15
Table 1.10: Specific investment costs for a new MSWI installation related to the annual capacity and some types of FGT in Germany .....	15
Table 1.11: Example of the comparative individual cost elements for MSW and HW incineration plants	16
Table 2.1: Typical reaction conditions and products from pyrolysis, gasification and incineration processes.....	20
Table 2.2: Prime impact of waste selection and pretreatment on residual waste .....	21
Table 2.3: Summary of the differences between operators in the HWI market .....	24
Table 2.4: Average composition of dewatered communal sewage sludge after dewatering .....	29
Table 2.5: Summary of the current successful application of thermal treatment techniques to the main waste types at dedicated installations .....	34
Table 2.6: Properties of various RDF (Refuse Derived Fuel) fractions treated in fluidised beds. ....	48
Table 2.7: Main operational criteria for stationary fluidised beds.....	50
Table 2.8: Operational criteria for a multiple hearth furnace .....	69
Table 2.9: Comparison of furnace systems for sewage sludge incineration.....	80
Table 2.10: Ranges and typical net calorific values for some incinerator input wastes .....	82
Table 2.11: Calculated NCV values for waste treated at 50 European MSWI plants.....	83
Table 2.12: Energy potential conversion efficiencies for different types of waste incineration plants .....	84
Table 2.13: Factors taken into account when selecting the design of the energy cycle for waste incineration plants .....	86
Table 2.14: Example data showing the variation in heat and electricity output when using various different types of heat pumps .....	96
Table 2.15: Steam-water cycle improvements: effect on efficiency and other aspects. ....	98
Table 2.16: Summary of the main differences between quench cooling and heat recovery.....	99
Table 2.17: Summary of the main applied FGT systems for MSWIs in Europe in 2000/2001 .....	101
Table 2.18: Tested continuous working measuring devices for emission measurements of mercury .....	141
Table 3.1: Distribution of various substances in an example MSWI installation (in mass %).....	145
Table 3.2: Percentage (%) distribution of heavy metals in a hazardous waste incineration process .....	145
Table 3.3: Average operational conditions during partitioning tests on a HWI installation .....	146
Table 3.4: PCDD/PCDF balance for a municipal waste incineration plant in Germany.....	146
Table 3.5: Example PCDD/F load data for an MSWI in France .....	147
Table 3.6: Flue-gas concentrations after the boiler (crude flue-gas) at various waste incineration plants (O <sub>2</sub> reference value 11 %) .....	148
Table 3.7: Total emissions relevant to climate change in Germany in the year 1999 compared with those arising from waste incineration .....	150
Table 3.8: Range of clean gas operation emissions levels reported from some European MSWI plants. ....	156
Table 3.9: Operational emission levels to air from MSWI expressed per tonne of MSW incinerated.....	157
Table 3.10: HCl emissions survey of European MSWIs.....	157
Table 3.11: HF emissions survey of European MSWIs .....	158
Table 3.12: Sulphur dioxide emissions survey of European MSWIs .....	158
Table 3.13: Dust emissions survey of European MSWIs .....	159
Table 3.14: Nitrogen oxides emissions survey of European MSWIs .....	159
Table 3.15: Total organic carbon emissions survey of European MSWIs .....	159
Table 3.16: PCDD/F (TEQ) emissions survey of European MSWIs .....	160
Table 3.17: Mercury emissions survey of European MSWIs.....	160
Table 3.18: Combined Cd and Hg emissions of selected MSWIs in France.....	161
Table 3.19: Emission results and techniques applied for Hg control at European MSWIs.....	161
Table 3.20: Typical range of clean gas emissions to air from hazardous waste incineration plants .....	162

Table 3.21: Survey data of the annual average emissions to air from hazardous waste incinerators in Europe.....	163
Table 3.22: Survey data of mass flow and annual sector emissions to air from merchant hazardous waste incinerators in Europe .....	164
Table 3.23: Typical values of the amount of scrubbing water arising from FGT at waste incineration plants treating low chlorine content wastes.....	174
Table 3.24: Other possible waste water sources, and their approximate quantities, from waste incineration plants.....	175
Table 3.25: Typical contamination of waste water from wet FGT facilities of waste incineration plants before treatment .....	176
Table 3.26: Releases to surface water and sewers from Dutch waste incinerators in 1999 .....	177
Table 3.27: Waste water quality (after treatment with Trimercaptotriazine) - Comparison between raw and treated waste water and various standards.....	178
Table 3.28: Annual average range of concentrations of the emissions to water after treatment from merchant hazardous waste installations that discharge waste water .....	179
Table 3.29: Mass flows of the emissions to water from surveyed merchant HWIs in Europe .....	180
Table 3.30: Typical data on the quantities of residues arising from municipal waste incineration plants. ....	186
Table 3.31: Mass streams of solid residues from MSWI expressed per tonne of MSW incinerated .....	187
Table 3.32: Concentration ranges of organic compounds in bottom, boiler and filter ashes .....	187
Table 3.33: PCDD/F concentrations in various MSWI incineration residues in NL (data 2000 – 2004).....	187
Table 3.34: Range of PCDD/F concentrations in MSWI residues (excluding peak high and low values) .....	188
Table 3.35: Leaching properties of mechanically treated bottom ash, measured using NEN7343.....	189
Table 3.36: Quantities of the main waste streams produced by HWI (European survey data).....	190
Table 3.37: Typical leaching values of bottom ash from hazardous waste incineration plants, measured using DIN-S4 .....	190
Table 3.38: Some factors and their influence on energy recovery options .....	192
Table 3.39: Energy equivalence conversion factors .....	194
Table 3.40: Electricity production and export rates per tonne of MSW .....	196
Table 3.41: Electricity production and export data per tonne of MSW for MSWI in France .....	196
Table 3.42: Heat production and export rates per tonne of MSW .....	196
Table 3.43: Heat production and export rates per tonnes of MSW for MSWI in France.....	196
Table 3.44: Average CHP percentage efficiency (calculated as energy equivalents) for 50 MSWI plants .....	197
Table 3.45: Average CHP recovery values per tonne of MSW in MSWI in France .....	197
Table 3.46: Survey data of MSWI boiler efficiencies.....	197
Table 3.47: Electricity, heat and total energy demand data for 50 surveyed European MSWI per tonne of waste treated.....	198
Table 3.48: Ratio of exported and consumed energy for various waste incinerators.....	200
Table 3.49: Sources of noise at waste incineration plants.....	201
Table 3.50: Stoichiometric calculation of amounts of lime used for absorption during flue-gas cleaning (reactants expressed at 100 % concentration and purity) .....	203
Table 3.51: Amount of additives used by merchant hazardous waste incineration processes .....	204
Table 4.1: Organisation chart for the information in Chapter 4.....	205
Table 4.2: Information breakdown for each technique described in this Chapter 4.....	206
Table 4.3: Some checking and sampling techniques applied to various waste types.....	213
Table 4.4: Some examples of applied storage techniques for various waste types.....	216
Table 4.5: Main techniques for reducing fugitive releases of odour, and GHG emissions.....	220
Table 4.6: Some segregation techniques applied for various waste types .....	221
Table 4.7: A comparison of combustion and thermal treatment technologies and factors affecting their applicability and operational suitability (table 1/3).....	236
Table 4.8: A comparison of combustion and thermal treatment technologies and factors affecting their applicability and operational suitability (table 2/3).....	237
Table 4.9: A comparison of combustion and thermal treatment technologies and factors affecting their applicability and operational suitability (table 3/3).....	239
Table 4.10: A comparison of the features of some different furnace geometries .....	242
Table 4.11: Crude flue-gas measurements at a test plant under normal operation, with IR camera and O <sub>2</sub> conditioning .....	249
Table 4.12: Some combustion specifications applied to incineration .....	266
Table 4.13: Relationship between nitrous oxide emissions and process temperatures for a bubbling fluidised bed plant burning sewage sludge .....	267
Table 4.14: Estimated cost impacts of some alterations to combustion parameters .....	269

Table 4.15: TWG energy sub-group survey data for specific energy flows at some European MSWIs per tonne of waste treated .....	285
Table 4.16: Techniques for the reduction of various energy losses at WI plants .....	291
Table 4.17: Plant throughput and total process energy demand for MSWI in Germany.....	293
Table 4.18: Example energy outputs and income at various steam pressures for a CHP MSWI using elevated steam pressures.....	298
Table 4.19: Relationship between the additional energy efficiency and the cooling medium (district heating) return temperature .....	308
Table 4.20: Cross-media effects associated with the use of various pre-dedusters .....	318
Table 4.21: Operational data associated with the use of pre-dedusting systems .....	319
Table 4.22: A comparison of dust removal systems.....	320
Table 4.23: Assessment of the applicability of pre-dedusting.....	320
Table 4.24: Emission levels associated with the use of BF flue-gas polishing systems.....	322
Table 4.25: Cross-media effects associated with the use of additional flue-gas polishing.....	322
Table 4.26: Operational data associated with the use of flue-gas polishing.....	323
Table 4.27: Assessment of the applicability of flue-gas polishing.....	323
Table 4.28: Cross-media effects associated with the use of double filtration .....	325
Table 4.29: Operational data associated with the use of double filtration.....	325
Table 4.30: Assessment of the applicability of double filtration.....	326
Table 4.31: Operational information for different bag filter materials.....	327
Table 4.32: Emission levels associated with the use of wet scrubbers.....	328
Table 4.33: Cross-media effects associated with the use of wet scrubber FGT .....	329
Table 4.34: Operational data associated with the use of wet FGT .....	330
Table 4.35: Assessment of the applicability of wet FGT .....	331
Table 4.36: Estimated investment costs of selected components of wet FGT systems .....	331
Table 4.37: Emission levels associated with the use of wet scrubbers.....	332
Table 4.38: Cross-media effects associated with the use of semi-wet acid gas treatment.....	333
Table 4.39: Operational data associated with the use of semi-wet FGT .....	334
Table 4.40: Assessment of the applicability of semi-wet FGT .....	335
Table 4.41: Estimated investment costs of selected components of typical semi-wet FGT systems.....	335
Table 4.42: Emission levels associated with the use of flash dry FGT.....	336
Table 4.43: Cross-media effects associated with the use of flash dry systems.....	337
Table 4.44: Operational data associated with the use of flash dry FGT .....	338
Table 4.45: Assessment of the applicability of flash dry FGT .....	338
Table 4.46: Emission levels associated with the use of dry lime FGT .....	339
Table 4.47: Emission levels associated with the use of dry sodium bicarbonate FGT .....	339
Table 4.48: Cross-media effects associated with the use of dry FGT.....	340
Table 4.49: Operational data associated with the use of dry FGT.....	340
Table 4.50: Assessment of the applicability of dry FGT .....	341
Table 4.51: Comparison of features of various alkaline reagents .....	342
Table 4.52: Assessment of the applicability of various alkaline reagents .....	343
Table 4.53: Operational data associated with the use of residue re-circulation.....	345
Table 4.54: Assessment of the applicability of residue re-circulation .....	346
Table 4.55: Assessment of the applicability of raw gas monitoring for optimisation of FGT.....	348
Table 4.56: Emission levels associated with the use of SCR.....	350
Table 4.57: Cross-media effects associated with the use of SCR.....	352
Table 4.58: Operational data associated with the use of SCR.....	352
Table 4.59: Assessment of the applicability of SCR.....	354
Table 4.60: Estimated investment costs of selected components of typical semi-wet FGT systems using SCR and SNCR .....	354
Table 4.61: Emission levels associated with the use of SNCR .....	356
Table 4.62: Cross-media effects associated with the use of SNCR.....	356
Table 4.63: Operational data associated with the use of SNCR .....	357
Table 4.64: Assessment of the applicability of SNCR .....	358
Table 4.65: Advantages and disadvantages of urea and ammonia use for SNCR.....	359
Table 4.66: Assessment of the applicability of PCDD/F reformation prevention techniques.....	362
Table 4.67: Assessment of the applicability of SCR for PCDD/F removal .....	364
Table 4.68: Destruction efficiency data for catalytic filter bags over 21 months of operation .....	366
Table 4.69: Assessment of the applicability of catalytic bag filters .....	366
Table 4.70: Assessment of the applicability of re-burn of absorbers .....	367
Table 4.71: Assessment of the applicability of carbon injection for PCDD/F removal .....	369
Table 4.72: Cross-media effects associated with the use of static filters .....	369
Table 4.73: Operational data associated with the use of static coke filters .....	370

Table 4.74: Assessment of the applicability of static coke filters .....	371
Table 4.75: Operational data associated with the use of carbon impregnated materials in wet scrubbers	372
Table 4.76: Assessment of the applicability of the use of carbon impregnated materials in wet scrubbers. .....	373
Table 4.77: Assessment of the applicability of wet scrubbing for Hg control .....	376
Table 4.78: Assessment of the applicability of carbon injection for Hg removal.....	377
Table 4.79: Assessment of the applicability of Na <sub>2</sub> S <sub>2</sub> O <sub>3</sub> for halogen removal.....	383
Table 4.80: Quantity of HCl (30 %) recovered per tonne of waste .....	395
Table 4.81: Quantities of Gypsum recovered per tonne of waste treated .....	396
Table 4.82: Slag output concentration (mg/kg) data reported for an example slag treatment facility .....	406
Table 4.83: Slag output eluate (ug/l) data reported for an example slag treatment.....	407
Table 4.84: Relative yield of various output fractions of wet bottom ash treatment .....	408
Table 4.85: Example of leaching results of the produced granulates.....	409
Table 4.86: Slag output concentration (mg/kg) data reported for an example slag treatment facility .....	409
Table 4.87: Slag output eluate (ug/l) data reported for an example slag treatment.....	409
Table 4.88: Relative costs of some ash treatment techniques .....	411
Table 4.89: Variations in solidification treatments for FGT residues between some countries.....	414
Table 4.90: FGT vitrification processes used in the US and Japan .....	416
Table 4.91: Examples of plants using the acid extraction process for FGT residue treatment .....	418
Table 4.92: Characteristics of some acid extraction processes used for FGT residue treatment.....	418
Table 5.1: How to combine the BAT described for a specific case .....	434
Table 5.2 Operational emission level ranges associated with the use of BAT for releases to air from waste incinerators.....	441
Table 5.3: An example assessment of some IPPC relevant criteria that may be taken into account when selecting between wet/semi-wet/dry FGT options .....	443
Table 5.4: BAT associated operational emission levels for discharges of waste water from effluent treatment plant receiving FGT scrubber effluent .....	446
Table 6.1: Residue quality using SYNCOM system.....	458
Table 6.2: Emission levels associated with the use of combined dry sodium bicarbonate and SCR FGT system .....	467
Table 6.3: Cross-media effects associated with the use of combined dry sodium bicarbonate and SCR FGT system.....	467
Table 6.4: Operational data associated with the use of combined dry sodium bicarbonate and SCR FGT system .....	468
Table 6.5: Assessment of the applicability of the combined dry sodium bicarbonate and SCR FGT system .....	468
Table 9.1: Country codes and currencies .....	488
Table 10.1: Treatment costs for a MSW Grate Incinerator with varying capacity .....	491
Table 10.2: Grate MSW incinerator costs 200000 t/yr Germany .....	492
Table 10.3: Estimated cost to build and operate a mass-burn MSW incineration plant of 200000 tonne capacity in Ireland .....	493
Table 10.4: Incinerator costs in Italy based on model calculations .....	495
Table 10.5: Fees and expected amount of waste to be incinerated at SIDOR facility, Luxembourg in 1999 .....	496
Table 10.6: Specific operational costs of the SIDOR MSWI in Luxembourg 1998 and 1999 .....	497
Table 10.7: Extract from the budget Of SIDOR for the years 1998 and 1999.....	498
Table 10.8: Capital investment and treatment costs for MSWI in NL.....	499
Table 10.9: Cost breakdown for various incinerators in Sweden .....	500
Table 10.10: UK gate fees for different incinerator capacities and energy outputs .....	500
Table 10.11: Breakdown of estimated United Kingdom incinerator costs .....	502
Table 10.12: Specific costs for discharge and storage facilities as a function of throughput when waste is delivered by refuse collection vehicles .....	505
Table 10.13: Specific costs for discharge and storage facilities as a function of throughput when waste is delivered by train .....	505
Table 10.14: Specific costs for a grate firing system and the boiler of waste incineration plants as a function of throughput .....	506
Table 10.15: Specific costs of a water-steam cycle with pure heat decoupling and feeding into district heating systems as a function of waste throughput .....	508
Table 10.16: Specific costs of a water-steam cycle comprising a steam extraction turbine as a function of waste throughput .....	509
Table 10.17: Specific costs of a water-steam cycle comprising a steam extraction turbine in combination with the steam system of an adjacent power plant as a function of waste throughput .....	510



Table 10.18: Specific costs of a water-steam cycle comprising cogeneration (CHP) and low steam parameters as a function of waste throughput .....	511
Table 10.19: Specific costs of a water-steam cycle comprising cogeneration (CHP) and high steam parameters as a function of waste throughput .....	511
Table 10.20: Specific costs of a water-steam cycle comprising a steam extraction turbine (normal steam parameters) as a function of waste throughput when energy can be substituted .....	511
Table 10.21: Specific costs of a water-steam cycle comprising cogeneration (CHP - normal steam parameters) as a function of waste throughput when energy can be substituted .....	512
Table 10.22: Specific costs of a water-steam cycle comprising cogeneration (CHP - high steam parameters) as a function of waste throughput when energy can be substituted .....	512
Table 10.23: Survey of specific income from different options of the water-steam cycle as a function of waste throughput .....	513
Table 10.24: Specific costs for dedusting with an electrostatic precipitator as a function of waste throughput .....	515
Table 10.25: Specific costs for wet dedusting as a function of waste throughput.....	515
Table 10.26: Specific costs of a dry flue-gas cleaning system with fabric filters as a function of waste throughput .....	516
Table 10.27: Specific costs of a dry flue-gas cleaning system with adsorption as a function of waste throughput .....	517
Table 10.28: Specific costs of a gypsum scrubber as a function of waste throughput .....	517
Table 10.29: Specific costs of a scrubber with precipitation as a function of waste throughput.....	518
Table 10.30: Specific costs of a NaOH scrubber as a function of waste throughput .....	518
Table 10.31: Specific costs of SCR as a function of waste throughput.....	519
Table 10.32: Specific costs of SNCR as a function of waste throughput.....	520
Table 10.33: Specific costs of a flow injection absorber as a function of waste throughput.....	520
Table 10.34: Specific costs of an activated coke plant as a function of waste throughput.....	521
Table 10.35: Option 1: Costs of a grate firing system incorporating delivery by train, dry, wet and catalytic flue-gas treatment and with the steam cycle connected to that of an adjacent power plant as a function of throughput.....	523
Table 10.36: Option 2: Costs of a grate firing system incorporating delivery by train, dry, wet and catalytic flue-gas treatment with power generation as a function of throughput.....	524
Table 10.37: Option 3: Costs of a grate firing system incorporating delivery by train, dry, wet and catalytic flue-gas treatment with cogeneration (CHP) as a function of throughput.....	524
Table 10.38: Option 4: Costs of a grate firing system incorporating delivery by train, electrostatic precipitator, NaOH scrubber, flow injection absorber and catalytic plant with power generation as a function of throughput .....	525
Table 10.39: Option 5: Costs of a grate firing system incorporating delivery by train, electrostatic precipitator, precipitation, activated coke absorber and catalytic plant with power generation as a function of throughput.....	525
Table 10.40: Option 6: Costs of a grate firing system incorporating delivery by train, dry adsorption, activated coke absorber and catalytic plant with power generation as a function of throughput .....	526
Table 10.41: Costs for the firing system and the boiler of waste incineration plants with fluidised bed combustion as a function of throughput (not including waste pretreatment costs).....	527
Table 10.42: Specific costs of a water-steam cycle comprising a steam extraction turbine (normal steam parameters) as a function of waste throughput .....	528
Table 10.43: Specific costs and income of waste treatment, firing, boiler and energy utilisation .....	528
Table 10.44: Capital and operating costs of the Lahti RDF gasification plant, Finland.....	529
Table 10.45: Hypothetical cost calculations for a pyrolysis plant in the Flanders Region of Belgium....	530
Table 10.46: General data of the waste incineration plant Flötzersteig (reference year: 2000) .....	531
Table 10.47: Input and output flows of the waste incineration plant Flötzersteig (reference year: 2000).....	532
Table 10.48: Emissions to air from the waste incineration plant Flötzersteig (reference year: 2000) .....	533
Table 10.49: Waste water parameters of the waste incineration plant Flötzersteig after the waste water treatment (reference year: 2000).....	534
Table 10.50: Chemical data of wastes from the waste incineration plant Flötzersteig (reference year: 2000).....	535
Table 10.51: Leaching tests; waste incineration plant Flötzersteig (reference year: 2000).....	536
Table 10.52: General data of the waste incineration plant Spittelau (reference year: 2000).....	536
Table 10.53: Input-output flows of the waste incineration plant Spittelau (reference year: 2000) .....	537
Table 10.54: Emissions to air from the waste incineration plant Spittelau (reference year: 2000) .....	539
Table 10.55: Waste water parameters of the waste incineration plant Spittelau after treatment (reference year: 2000).....	540

Table 10.56: Chemical data of waste fractions from the waste incineration plant Spittelau (reference year: 2000).....	541
Table 10.57: Leaching tests; waste incineration plant Spittelau (reference year: 2000).....	542
Table 10.58: General data of the waste incineration plant Wels (reference year: 2000).....	542
Table 10.59: Input and output of the waste incineration plant Wels (reference year: 2000).....	543
Table 10.60: Emissions to air from the waste incineration plant Wels (reference year: 2000).....	545
Table 10.61: Waste water parameters of the waste incineration plant Wels after waste water treatment (reference year: 2000).....	546
Table 10.62: Average values measured in clean gas (operating values).....	547
Table 10.63: Slag quality.....	548
Table 10.64: Energy efficiency ratio (assumed average calorific value $\approx 9500$ kJ/kg).....	548
Table 10.65: Types of waste and waste quantities incinerated in the rotary kilns of Plant Simmeringer Haide (reference year: 2000).....	554
Table 10.66: General data of the rotary kilns of the Plant Simmeringer Haide (reference year: 2000).....	554
Table 10.67: Input and output flows of the rotary kilns of the Plant Simmeringer Haide (reference year: 2000).....	555
Table 10.68: Emissions to air from the rotary kilns of the Plant Simmeringer Haide (reference year: 2000).....	557
Table 10.69: Waste water parameters of the rotary kilns of the Plant Simmeringer Haide after waste water treatment (reference year: 2000).....	558
Table 10.70: Chemical data of wastes from the rotary kilns (reference year: 2000).....	559
Table 10.71: Leaching tests (according to ÖNORM S 2115) rotary kilns of the Plant Simmeringer Haide (reference year: 2000).....	559
Table 10.72: Average values measured in clean gas (operating values).....	560
Table 10.73: General data of the fluidised bed reactors of the Plant Simmeringer Haide (2000).....	562
Table 10.74: Input and output flows of the fluidised bed reactors (reference year: 2000).....	563
Table 10.75: Emissions to air from the fluidised bed reactors (reference year: 2000).....	564
Table 10.76: Chemical data of wastes from the fluidised bed reactors (reference year: 2000).....	565
Table 10.77: Leaching tests according to ÖNORM S 2115 – fluidised bed reactors (reference year: 2000).....	565
Table 10.78: Characterization of the incineration materials.....	566
Table 10.79: Average values measured in clean gas (operating values) – BAT5.....	566
Table 10.80: Characterization of the incineration material.....	567
Table 10.81: Average values measured in clean gas (operating values) – BAT6.....	567
Table 10.82: Emission values of the waste water from the waste gas cleaning system before mixing (BAT6).....	568
Table 10.83: Types of waste and waste quantities treated at AVE - Reststoffverwertung Lenzing (reference year: 2000).....	569
Table 10.84: General data of the fluidised bed reactor of AVE-RVL Lenzing.....	569
Table 10.85: Emissions to air from the fluidised bed reactor of AVE - Reststoffverwertung Lenzing.....	572
Table 10.86: General data of the fluidised bed reactor of the waste incineration plant Arnoldstein (reference year: 2001).....	573
Table 10.87: Output flows of the fluidised bed reactors of the waste incineration plant Arnoldstein (reference year: 2001).....	574
Table 10.88: Emissions to air from the waste incineration plant Arnoldstein (reference year: 2001).....	576
Table 10.89: Waste water parameters (composite sample) of the waste incineration plant Arnoldstein after waste water treatment (reference year: 2001).....	576
Table 10.90: Chemical data of ash from the fluidised bed combustion of the waste incineration plant Arnoldstein (reference year: 2001).....	577
Table 10.91: Concentration of pollutants in the eluate of ash from the waste incineration plant Arnoldstein (reference year: 2001).....	577
Table 10.92: Average values measured in clean gas (operating values).....	578
Table 10.93: Measuring devices used for continuous measuring.....	578
Table 10.94: Deposition degrees in waste gas cleaning.....	579
Table 10.95: Energy efficiency ratio (supposed average calorific value $H_u \approx 11500$ kJ/kg).....	579
Table 10.96: Slag quality – BAT2.....	580
Table 10.97: Energy efficiency calculation data checklist 1.....	593
Table 10.98: Energy efficiency calculation data checklist 2.....	594
Table 10.99: Energy efficiency calculation data checklist 3.....	595
Table 10.100: Example of a multi-criteria assessment of FGT system selection.....	601
Table 10.101: Example of a multi-criteria cost assessment used for comparing FGT system options.....	602

---

## SCOPE

The following comments are relevant to the scope of this document:

1. The scope of this document is mainly influenced by the scope of the information provided by, and decisions of, the members of the Technical Working Group (TWG) on waste incineration, and the time and resources available.
2. Annexe 1 of the IPPC Directive (96/61/EC) provided the starting point for the scope of this BAT reference document, where it includes sections as follows:

*5.1. Installations for the disposal or recovery of hazardous waste as defined in the list referred to in Article 1 (4) of Directive 91/689/EEC, as defined in Annexes II A and II B (operations R1, R5, R6, R8 and R9) to Directive 75/442/EEC and in Council Directive 75/439/EEC of 16 June 1975 on the disposal of waste oils (2), with a capacity exceeding 10 tonnes per day*

*5.2. Installations for the incineration of municipal waste as defined in Council Directive 89/369/EEC of 8 June 1989 on the prevention of air pollution from new municipal waste incineration plants (3) and Council Directive 89/429/EEC of 21 June 1989 on the reduction of air pollution from existing municipal waste-incineration plants (4) with a capacity exceeding 3 tonnes per hour*

The TWG working on this document decided at an early stage that the document should not be restricted by the size limitations in these sections of the IPPC Directive, nor by the definitions of waste, and recovery or disposal included therein. This being the case, the selected scope of the document aimed to reflect a pragmatic view across the incineration sector as a whole, with a particular focus upon those installations and waste types that are most common. The scope of the Waste Incineration Directive 76/2000/EC was also a factor taken into account by the TWG when deciding on the scope for the document.

3. The document seeks to provide information concerning dedicated waste incineration installations. It does not cover other situations where waste is thermally treated, e.g. co-incineration processes such as some cement kilns and large combustion plants - these situations are (or will be) covered by the BREF that deals specifically with those industries. While some of the techniques that are included here may be technically applicable to other industries (i.e. those that are not dedicated incinerators) that incinerate waste, or a proportion of waste, whether the techniques identified here, or the performance levels they give rise to, are BAT for those sectors, has not been a part of the scope of this work.
4. Although incineration provides the main focus of this document, three main thermal treatment techniques are described, in general as they relate to some common waste streams. These are:
  - incineration
  - pyrolysis
  - gasification.

Various incineration techniques are covered. Incineration is applied to the treatment of a very wide variety of wastes. Pyrolysis and gasification are less widely applied to wastes, and generally to a narrower range of wastes.

Combinations of incineration, pyrolysis and gasification are also referred to. Each of the techniques and combinations of techniques are covered in this document within the context of their application to the treatment of various wastes (although this does not imply any definition of the meaning of *waste* - see also comment 5 below)

5. In addition to the thermal treatment stage of the installation this document also covers (to varying degrees):
  - waste reception, handling and storage
  - the effect of waste pretreatment on the selection and operation of waste incineration processes (in some cases this includes a description of the techniques applied)
  - applied flue-gas treatment techniques
  - applied residue treatments techniques (for the main residues commonly produced)
  - applied waste water treatment techniques
  - some aspects of energy recovery, the performance achieved and techniques used (details of electrical generation equipment etc. are not included).
6. If an installation is referred to or included in this document this does not have any legal consequence. It does not mean that the installation is legally classed as an *incinerator* nor does it imply that the material being treated is legally classed as *waste*
7. No size threshold has been applied when gathering information. However, it is noted that, to date, limited information has been supplied concerning smaller incineration processes
8. This document does not deal with decisions concerning the selection of incineration as a waste treatment option. Neither, does it compare incineration with other waste treatments.
9. There is another BREF that deals with “Waste Treatments”. It has a wide scope and covers many other installations and techniques that are applied to the treatment of waste.

# 1 GENERAL INFORMATION ON WASTE INCINERATION

## 1.1 Purpose of incineration and basic theory

[1, UBA, 2001], [64, TWGComments, 2003]

Incineration is used as a treatment for a very wide range of wastes. Incineration itself is commonly only one part of a complex waste treatment system that altogether, provides for the overall management of the broad range of wastes that arise in society.

The incineration sector has undergone rapid technological development over the last 10 to 15 years. Much of this change has been driven by legislation specific to the industry and this has, in particular, reduced emissions to air from individual installations. Continual process development is ongoing, with the sector now developing techniques which limit costs, whilst maintaining or improving environmental performance.

The objective of waste incineration is to treat wastes so as to reduce their volume and hazard, whilst capturing (and thus concentrating) or destroying potentially harmful substances that are, or may be, released during incineration. Incineration processes can also provide a means to enable recovery of the energy, mineral and/or chemical content from waste.

Basically, waste incineration is the oxidation of the combustible materials contained in the waste. Waste is generally a highly heterogeneous material, consisting essentially of organic substances, minerals, metals and water. During incineration, flue-gases are created that will contain the majority of the available fuel energy as heat.

The organic fuel substances in the waste will burn when they have reached the necessary ignition temperature and come into contact with oxygen. The actual combustion process takes place in the gas phase in fractions of seconds and simultaneously releases energy where the calorific value of the waste and oxygen supply is sufficient, this can lead to a thermal chain reaction and self-supporting combustion, i.e. there is no need for the addition of other fuels.

The main stages of incineration process are:

**1. drying and degassing** – here, volatile content is evolved (e.g. hydrocarbons and water) at temperatures generally between 100 and 300 °C. The drying and degassing process do not require any oxidising agent and are only dependent on the supplied heat

**2. pyrolysis and gasification** - pyrolysis is the further decomposition of organic substances in the absence of an oxidising agent at approx. 250 – 700 °C. Gasification of the carbonaceous residues is the reaction of the residues with water vapour and CO<sub>2</sub> at temperatures, typically between 500 and 1000 °C, but can occur at temperatures up to 1600 °C. Thus, solid organic matter is transferred to the gaseous phase. In addition to the temperature, water, steam and oxygen support this reaction

**3. oxidation** - the combustible gases created in the previous stages are oxidised, depending on the selected incineration method, at flue-gas temperatures generally between 800 and 1450 °C.

These individual stages generally overlap, meaning that spatial and temporal separation of these stages during waste incineration may only be possible to a limited extent. Indeed the processes partly occur in parallel and influence each other. Nevertheless it is possible, using in-furnace technical measures, to influence these processes so as to reduce polluting emissions. Such measures include furnace design, air distribution and control engineering.

In fully oxidative incineration the main constituents of the flue-gas are: water vapour, nitrogen, carbon dioxide and oxygen. Depending on the composition of the material incinerated and on the operating conditions, smaller amounts of CO, HCl, HF, HBr, HI, NO<sub>x</sub> SO<sub>2</sub>, VOCs, PCDD/F, PCBs and heavy metal compounds (among others) are formed or remain. Depending on the combustion temperatures during the main stages of incineration, volatile heavy metals and inorganic compounds (e.g. salts) are totally or partly evaporated. These substances are transferred from the input waste to both the flue-gas and the fly ash it contains. A mineral residue fly ash (dust) and heavier solid ash (bottom ash) are created. In municipal waste incinerators, bottom ash is approximately 10 % by volume and approximately 20 to 30 % by weight of the solid waste input. Fly ash quantities are much lower, generally only a few per cent of input. The proportions of solid residue vary greatly according to the waste type and detailed process design.

For effective oxidative combustion, a sufficient oxygen supply is essential. The air ratio number "n" of the supplied incineration air to the chemically required (or stoichiometric) incineration air, usually ranges from 1.2 to 2.5, depending on whether the fuel is gas, liquid or solid, and the furnace system.

The combustion stage is only one stage of the overall incineration installation. Incinerators usually comprise a complex set of interacting technical components which, when considered together, effect an overall treatment of the waste. Each of these components has a slightly different main purpose, as described in Table 1.1 below:

Objective	Responsibility of
<ul style="list-style-type: none"> <li>• destruction of organic substances</li> <li>• evaporation of water</li> <li>• evaporation of volatile heavy metals and inorganic salts</li> <li>• production of potentially exploitable slag</li> <li>• volume reduction of residues</li> </ul>	Furnace
<ul style="list-style-type: none"> <li>• recovery of useable energy</li> </ul>	Energy recovery system
<ul style="list-style-type: none"> <li>• removal and concentration of volatile heavy metals and inorganic matter into solid residues e.g. flue-gas cleaning residues, sludge from waste water treatment</li> <li>• minimising emissions to all media</li> </ul>	Flue-gas cleaning

**Table 1.1: Purpose of various components of a waste incinerator**

Source [1, UBA, 2001], [64, TWGComments, 2003]

## 1.2 Overview of waste incineration in Europe

The scale of use of incineration as a waste management technique varies greatly from location to location. For example, in European Member States the variation of incineration in municipal waste treatments ranges from zero to 62 per cent.

[9, VDI, 2002] In EU-15 Member States (MS) an annual quantity of approximately 200 million tonnes of waste may be considered suitable for thermal waste treatment. However, the total installed capacity of thermal waste treatment plants is only in the order of 50 million tonnes.

Table 1.2 below gives an estimate of the treatment of the waste arising in each MS for municipal waste, hazardous waste and sewage sludge. Deposited waste is included because a considerable proportion of these wastes may, in future, be diverted to other waste treatment methods, including incineration.

Note: as definitions and waste categories differ from one country to another, some of the values given may not be directly comparable.

Country	Municipal Solid Waste (MSW)				Hazardous Waste (HW)				Sewage Sludge (SS)	
	Total estimated MSW-production (in 10 <sup>6</sup> tonnes)	Year of data source	% landfilled (or amount in 10 <sup>6</sup> tonnes)	% incinerated (or amount in 10 <sup>6</sup> tonnes)	Total estimated HW-production (in 10 <sup>6</sup> tonnes)	Year of data source	Amount landfilled (in 10 <sup>6</sup> tonnes)	Amount incinerated (in 10 <sup>6</sup> tonnes)	Total estimated SS-production (in 10 <sup>6</sup> tonnes as dry solids)	Year of data source
Austria	1.32	1999	51	35	0.97	1999	<i>Not supplied</i>	0.11	0.39	1999
Belgium	4.85	1997	42	35	2.03	1997	0.79	0.14	0.85	1997
Denmark	2.77	1996	15	56	0.27	1996	0.09	0.1	0.15	1997
Finland	0.98	1997	77	2	0.57	1997	0.28	0.1	0.14	1997
France	48.5	2000	55	26	<i>Not supplied</i>	1997 2001	<i>Not supplied</i>	0.77 (note 5)	0.82	1997
Germany	45	2000	30	29	9.17	2000	2.7	0.85	2.48	1998
Greece	3.20	1993	93	0	<i>Not supplied</i>	1993	<i>Not supplied</i>	<i>Not supplied</i>	<i>Not supplied</i>	<i>Not supplied</i>
Ireland	1.80	1998	100	0	0.23	1995	0.03	0.03	0.39	1997
Italy	25.40	1995	85	8	<i>Not supplied</i>	1995	<i>Not supplied</i>	<i>Not supplied</i>	<i>Not supplied</i>	<i>Not supplied</i>
Luxembourg	0.30	1995	24	48	0.14	1995	<i>Not supplied</i>	<i>Not supplied</i>	<i>Not supplied</i>	<i>Not supplied</i>
Portugal	4.6	2002	71	20	0.25	2001	<i>Not supplied</i>	<i>Not supplied</i>	0.24	2000
Spain	17	1997	85	10	2	1997	<i>Not supplied</i>	0.03	<i>Not supplied</i>	<i>Not supplied</i>
Sweden	3.80	1999 (note 1)	24 (0.92)	38 (1.44)	0.27	1999	<i>Not supplied</i>	0.1		1997
Netherlands	10.2	2002	11	76	2.7	2002	0.6	0.28	0.69	1999
United Kingdom	27.20	1999	85	6	2.37	1996	0.86	0.24	1.2	1999 (note 3)
<b>EU-15 Totals (note 6)</b>	<b>196.92</b>				<b>21.92</b>		<b>5.35</b>	<b>2.72</b>	<b>7.58</b>	

**Notes**  
1 Swedish Waste Management 2000 (RVF)  
2  
3 ENDS Report 312 January 2001 (figures include co-incineration (50 %/50 %)  
4 The balance to 100 % for the treatment methodologies is e.g. due to recovery and recycling  
5 Hazardous waste incinerated in external dedicated units  
6 Totals given are a simple addition of figures provided and therefore are of mixed years. Percentages landfilled etc not averaged as figures have little meaning without actual mass data.

**Table 1.2: Amounts of municipal waste (MSW), hazardous waste (HW) and sewage sludge (SS) in EU-15 MSs, and their treatment [1, UBA, 2001], [64, TWGComments, 2003]**

Table 1.3 shows the quantities of some wastes arising and number of waste incinerator plants in other European Countries:

Country	Data year	Municipal waste in 10 <sup>6</sup> tonnes	Total number of MSWI	MSWI (>3 t/h)	Hazardous waste in 10 <sup>6</sup> tonnes	Total number of HWI	HWI (>10 t/d)
Bulgaria	1998	3.199	0	0	0.548	0	0
Czech Republic	1999	4.199	3	3	3.011	72	14
Estonia	1999	0.569	0	0	0.06	1	0
Hungary	1998	5	1	1	3.915	7	<i>Not supplied</i>
Latvia	1998	0.597	0	0	0.0411	0	0
Lithuania	1999	1.211	0	0	0.2449	0	0
Poland	1999	12.317	4	1	1.34	13	4
Romania	1999	7.631	0	0	2.323	3	3
Slovakia	1999	3.721	2	2	1.7376	<i>Not supplied</i>	1
Slovenia	1995	1.024	0	0	0.025	0	0
<b>Totals</b>		<b>39.468</b>	<b>10</b>	<b>7</b>	<b>13.2456</b>	<b>96</b>	<b>22</b>

Note: Totals are simple column totals and therefore include mixed year data

**Table 1.3: Annual quantities of municipal and hazardous waste arising and the number of incineration plants in some Accession Countries**  
[1, UBA, 2001], [64, TWGComments, 2003]

Table 1.4 shows the number and total capacity of existing incineration plants (not including planned sites) for various waste types:

Country	Total number of MSW-incinerators	Capacity Mt/yr	Total number of HW-incinerators	Capacity Mt/yr	Total number of dedicated sewage sludge incinerators	Capacity Mt/yr (dry solids)
Austria	5	0.5	2	0.1	1	
Belgium	17	2.4	3	0.3	1	0.02
Denmark	32	2.7	2	0.1	5	0.3
Finland	1	0.07	1	0.1		
France	210 <sup>1</sup>	11.748	20 <sup>3</sup>	1.0		
Germany	59	13.4	31 <sup>2</sup>	1.23	23	0.63
Greece	0		0			
Ireland	0		11			
Italy	32	1.71	6	0.1		
Luxembourg	1	0.15	0			
Portugal	3	1.2	0			
Spain	9	1.13	1	0.03		
Sweden	30	2.5	1	0.1		
Netherlands	11	5.3	1	0.1	2	0.19
United Kingdom	17	2.97	3	0.12	11	0.42
Norway	11	0.65				
Switzerland	29	3.29	11	2	14	0.1
<b>Totals</b>	<b>467</b>	<b>49.7</b>	<b>93</b>	<b>5.28</b>	<b>57</b>	<b>1.66</b>

1 On 6 Jan 2003 123 MSW incinerators were operating with combined capacity of 2000t/h  
2 Figure includes installations used in the chemical industry  
3 Dedicated commercial sites only (i.e. not including in-house plants)

**Table 1.4: Geographical distribution of incineration plants for municipal, hazardous and sewage sludge waste**  
[1, UBA, 2001], [64, TWGComments, 2003]



Figure 1.1 shows the variation in per capita capacity for municipal waste incineration:

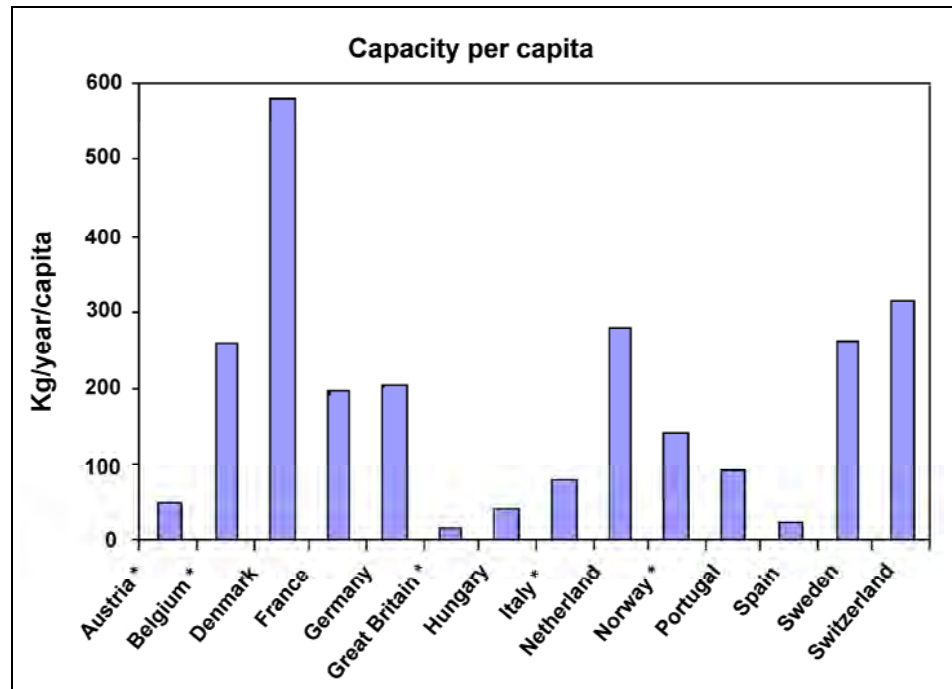

Figure 1.1: Municipal waste incineration capacity per capita

\* means incomplete data [42, ISWA, 2002], [64, TWGComments, 2003]

### 1.3 Plant sizes

The size of installations varies greatly across Europe. Variations in size can be seen within and between technology and waste types. The largest MSW plant in Europe has a capacity in excess of 1 million tonnes of waste per year. Table 1.5 below shows the variation in average MSW incinerator capacity by country:

Country	Average MSW incinerator capacity (k tonnes/yr)
Austria	178
Belgium	141
Denmark	114
France	132
Germany	257
Italy	91
Netherlands	488
Portugal	390
Spain	166
Sweden	136
United Kingdom	246
Norway	60
Switzerland	110
<b>AVERAGE</b>	<b>193</b>

Table 1.5: Average MSW incineration plant capacity by country

[11, Assure, 2001], [64, TWGComments, 2003]

Table 1.6 below shows the typical application range of the main different incineration technologies:

Technology	Typical application range (tonnes/day)
Moving grate (mass burn)	120 - 720
Fluidised bed	36 – 200
Rotary kiln	10 – 350
Modular (starved air)	1 – 75
Pyrolysis	10 - 100
Gasification	250 - 500

Note: values are for typical applied ranges –each is also applied outside the range shown.

**Table 1.6: Typical throughput ranges of thermal treatment technologies**  
[10, Juniper, 1997], [64, TWGComments, 2003]

## 1.4 Overview of legislation

The waste incineration sector has been the subject of extensive legislative requirements at regional, national and European level for many years.

In addition to the requirements of the IPPC Directive, the incineration (and associated) sector is also subject to the requirements of specific legislation. At present, the following EU-directives are in force for waste incineration plants:

- 89/369/EEC for new municipal waste incineration plants
- 89/429/EEC for existing municipal waste incineration plants
- 94/67/EC for the incineration of hazardous waste (including co-incineration)
- 2000/76/EC for the incineration of waste (including co-incineration).
- Regulation (EC) No. 1774/2002 of the European Parliament and of the Council of 3 October 2002, laying down health rules concerning animal by-products not intended for human consumption.

It should be noted that Directive 2000/76/EC progressively repeals the first three directives. This directive sets the minimum requirements in respect of permissible emissions, monitoring and certain operational conditions. The scope of 2000/76/EC is broad (certain exclusions are specifically listed in Article 2) and does not have a lower capacity limit.

Directive 2000/76/EC requires that its standards are adopted as follows:

- new waste incineration plants, from 28 December 2002
- existing waste incineration plants, by 28 December 2005 at the latest.

In the meantime, existing waste incineration plants have to comply with Directives 89/369/EEC, 89/429/EEC and 94/67/EC. [2, infomil, 2002]

## 1.5 Waste composition and process design

The precise design of a waste incineration plant will change according to the type of waste that is being treated. The following parameters and their variability are key drivers:

- waste chemical composition
- waste physical composition, e.g. particle size
- waste thermal characteristics, e.g. calorific value, moisture levels, etc.

Processes designed for a narrow range of specific inputs can usually be optimised more than those that receive wastes with greater variability. This in turn can allow improvements to be made in process stability and environmental performance, and may allow a simplifying of downstream operations such as flue-gas cleaning. As flue-gas cleaning is often a significant contributor to overall incineration costs (i.e. approx 15 to 35 % of the total capital investment) this can then lead to reduced treatment costs at the incinerator. The external costs (i.e. those generally beyond the IPPC permit assessment boundary) of pretreatment, or the selective collection of certain wastes can however add significantly to the overall costs of waste management and to emissions from the entire waste management system. Often, decisions concerning the wider management of waste (i.e. the complete waste arising, collection, transportation, treatment, disposal etc.) take into account a very large number of factors. The selection of the incineration process can form a part of this wider process.

The waste collection and pretreatment systems utilised can have a great impact on the type and nature of waste that will finally be received at the incinerator (e.g. mixed municipal waste or RDF) and hence on the type of incinerator that is best suited to this waste. Provision for the separate collection of various fractions of household waste can have a large influence over the average composition of the waste received at the MSWI. For example, the separate collection of some batteries and dental amalgam can significantly reduce mercury inputs to the incineration plant. [64, TWGComments, 2003]

The cost of the processes used for the management of residues arising at the incinerator, and for the distribution and use of the energy recovered also play a role in the overall process selection.

In many cases, waste incinerators may have only limited control over the precise content of the wastes they receive. This then results in the need for some installations to be designed so that they are sufficiently flexible to cope with the wide range of waste inputs they could receive. This applies to both the combustion stage and the subsequent flue-gas cleaning stages.

The main types of waste to which incineration is applied as a treatment are:

- municipal wastes (residual wastes - not pretreated)
- pretreated municipal wastes (e.g. selected fractions or RDF)
- non-hazardous industrial wastes and packaging
- hazardous wastes
- sewage sludges
- clinical wastes.

[64, TWGComments, 2003] Many incineration plants accept several of these types of waste. Waste itself is commonly classified in a number different ways:

- by origin, e.g. household, commercial, industrial, etc.
- by its nature, e.g. putrescible, hazardous, etc.
- by the method used for its management, e.g. separately collected, recovered material, etc.

These different classes overlap. For example, wastes of various origins may contain putrescible or hazardous fractions.

Table 1.7 below provides data concerning the content of waste arising in Germany. The term *hazardous waste* refers to those wastes classified as hazardous under Directive 91/689/EC. Sewage sludge includes sludge from the waste water treatment of communities and industries:

Parameter	Municipal waste	Hazardous waste	Sewage sludge
Calorific value (upper) (MJ/kg)	7 – 15	1 – 42	2 – 14
Water (%)	15 – 40	0 – 100	3 – 97
Ash	20 – 35	0 – 100	1 – 60
Carbon (% d.s.)	18 – 40	5 – 99	30 – 35
Hydrogen (% d.s.)	1 – 5	1 – 20	2 – 5
Nitrogen (% d.s.)	0.2 – 1.5	0 – 15	1 – 4
Oxygen (% d.s.)	15 - 22	<i>not supplied</i>	10 – 25
Sulphur (% d.s.)	0.1 - 0.5	<i>not supplied</i>	0.2 - 1.5
Fluorine (% d.s.)	0.01 – 0.035	0 - 50	0.1 - 1
Chlorine (% d.s.)	0.1 – 1	0 - 80	0.05 - 4
Bromine (% d.s.)	<i>not supplied</i>	0 - 80	No data
Iodine (% d.s.)		0 - 50	No data
Lead mg/kg d.s.)	100 – 2000	0 - 200000	4 - 1000
Cadmium mg/kg d.s.)	1 – 15	0 – 10000	0.1 – 50
Copper mg/kg d.s.)	200 – 700	<i>not supplied</i>	10 – 1800
Zinc mg/kg d.s.)	400 – 1400	<i>not supplied</i>	10 – 5700
Mercury mg/kg d.s.)	1 – 5	0 – 40000	0.05 – 10
Thallium mg/kg d.s.)	<0.1	<i>not supplied</i>	0.1 – 5
Manganese mg/kg d.s.)	250	<i>not supplied</i>	300 – 1800
Vanadium mg/kg d.s.)	4 – 11	<i>not supplied</i>	10 – 150
Nickel mg/kg d.s.)	30 – 50	<i>not supplied</i>	3 – 500
Cobalt mg/kg d.s.)	3 – 10	<i>not supplied</i>	8 – 35
Arsenic mg/kg d.s.)	2 – 5	<i>not supplied</i>	1 – 35
Chrome mg/kg d.s.)	40 - 200	<i>not supplied</i>	1 – 800
Selenium mg/kg d.s.)	0.21 - 15	<i>not supplied</i>	0.1 – 8
PCB mg/kg d.s.)	0.2 – 0.4	Up to 60 %	0.01 – 0.13
PCDD/PCDF (ng I-TE/kg)	50 – 250	10 – 10000	8.5 – 73
Notes: % d.s. means percentage dry solids the calorific value for sewage sludge relates to raw sludge of >97 % d.s. Sub-fractions of HW can show variations outside these ranges			

**Table 1.7: Typical composition of waste in Germany**  
[1, UBA, 2001], [64, TWGComments, 2003]

The range of installation designs is almost as wide as the range of waste compositions.

New plants have the advantage that a specific technological solution can be designed to meet the specific nature of the waste to be treated in the plant. They also benefit from years of industry development and knowledge of the practical application of techniques and may therefore be designed for high environmental standards, whilst containing costs.

Existing plants have significantly less flexibility when selecting upgrade options. Their design may be the product of 10 to 20 years of process evolution. Often in Europe this will have been motivated by requirements to reduce emissions to air. The next stage of process development will often then be highly (or even totally) dependent upon the existing design. Many site-specific local solutions can be seen in the sector. Many of these would probably be constructed in a different way if completely rebuilt. [6, EGTEI, 2002]

## 1.6 Key environmental issues

Waste itself, and its management, are themselves a significant environmental issue. The thermal treatment of waste may therefore be seen as a response to the environmental threats posed by poorly or unmanaged waste streams.

The target of thermal treatment (see also Section 1.1) is to provide for an overall reduction in the environmental impact that might otherwise arise from the waste. However, in the course of the operation of incineration installations, emissions and consumptions arise, whose existence or magnitude are influenced by the installation design and operation. This section therefore, briefly, summarises the main environmental issues that arise directly from incineration installations (i.e. it does not include the wider impacts or benefits of incineration). Essentially these *direct impacts* fall into the following main categories:

- overall process emissions to air and water (including odour)
- overall process residue production
- process noise and vibration
- energy consumption and production
- raw material (reagent) consumption
- fugitive emissions – mainly from waste storage
- reduction of the storage/handling/processing risks of hazardous wastes.

Other impacts beyond the scope of this BREF document (but which can significantly impact upon the overall environmental impact of an entire project) arise from the following operations:

- transport of incoming waste and outgoing residues
- extensive waste pretreatment (e.g. preparation of waste derived fuels and the associated refuse treatment).

### 1.6.1 Process emissions to air and water

Emissions to air have long been the focus of attention for waste incineration plants. Significant advances in technologies for the cleaning of flue-gases in particular have led to major reductions in the emissions to air.

However, the control of emissions to air remains an important issue for the sector. As the entire incineration process is usually under slightly negative pressure (because of the common inclusion of an induced draught extraction fan), routine emissions to air generally take place exclusively from the stack. [2, infomil, 2002]

A summary of the main emissions to air from stack releases (these are described in more detail in Section 3.2.1) is shown below:

- particulate matter, –particulate matter - various particle sizes
- acid and other gases, –including HCl, HF, HBr, HI, SO<sub>2</sub>, NO<sub>x</sub>, NH<sub>3</sub> amongst others
- heavy metals, –including Hg, Cd, Tl, As, Ni, Pb, amongst others
- carbon comp. (non-GHG), –including, CO, hydrocarbons (VOCs), PCDD/F, PCB amongst others.

Other releases to air may include, if there is no measure to reduce them:

- odour, –from handling and storage of untreated waste
- green house gases (GHGs) –from decomposition of stored wastes e.g. methane, CO<sub>2</sub>
- dusts, –from dry reagent handling and waste storage areas.

The principle potential sources of releases to water (process dependent) are:

- effluents from air pollution control devices, e.g. salts, heavy metals (HMs)
- final effluent discharges from waste water treatment plants, e.g. salts, heavy metals
- boiler water - blowdown bleeds, e.g. salts
- cooling water - from wet cooling systems, e.g. salts, biocides
- road and other surface drainage, e.g. diluted waste leachates
- incoming waste storage, handling and transfer areas, e.g. diluted incoming wastes
- raw material storage areas, e.g. treatment chemicals
- residue handling, treatment and storage areas, e.g. salts, HMs, organics.

The waste water produced at the installation can contain a wide range of potentially polluting substances depending upon its actual source. The actual release made will be highly dependent on the treatment and control systems applied.

### 1.6.2 Installation residues production

The nature and quantity of residues produced are a key issue for the sector. This is because they provide both: (1) a measure of the completeness of the incineration process, and (2) generally represent the largest potential waste arising at the installation.

[64, TWGComments, 2003], [1, UBA, 2001] Although the types and quantities of residue arising varies greatly according to the installation design, its operation and waste input, the following main waste streams are commonly produced during the incineration process:

- ashes and/or slag
- boiler ashes
- filter dust
- other residues from the flue-gas cleaning (e.g. calcium or sodium chlorides)
- sludge from waste water treatment.

In some cases, the above waste streams are segregated; in other cases, they are combined within or outside the process.

Some thermal treatment residues (most commonly vitrified slags from very high temperature processes) can be used directly without treatment. Substances which can be obtained after the treatment of the bottom ashes are:

- construction materials
- ferrous metals
- non ferrous metals.

In addition, some plants using wet FGC processes with additional specific equipment recover:

- calcium sulphate (Gypsum)
- hydrochloric acid
- sodium carbonate
- sodium chloride.

Of these outputs, although very dependent upon the waste type, bottom ashes are generally produced in the largest quantities. In many locations, often depending on local legislation and practice, bottom ash is treated for re-cycling as an aggregate replacement.

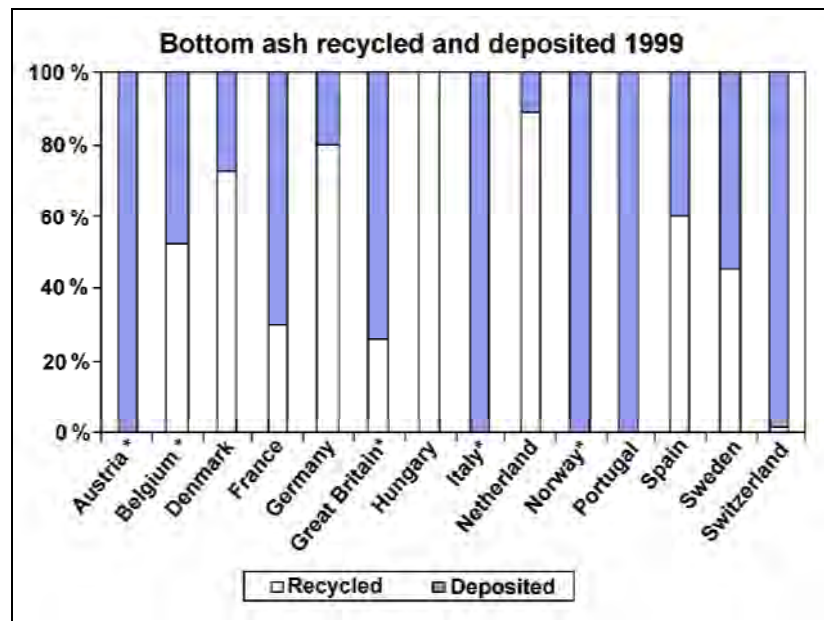

**Figure 1.2: Bottom ash recycled and deposited from MSWI in 1999**  
 \*means incomplete data [42, ISWA, 2002]

Residues produced from the flue-gas cleaning are an important source of waste production. The amount and nature of these varies, mainly according to the types of waste being incinerated and the technology that is employed.

### 1.6.3 Process noise and vibration

[2, infomil, 2002] The noise aspects of waste incineration are comparable with other heavy industries and with power generation plants. It is common practice for new municipal waste incineration plants to be installed in completely closed building(s), as far as possible. This normally includes operations such as the unloading of waste, mechanical pretreatment, flue-gas treatment, and the treatment of residues. Usually, only some parts of flue-gas cleaning systems (pipes, tubes, SCR, heat exchangers, etc.), cooling facilities and the long-term storage of bottom ash are carried out directly in the open air.

The most important sources of external noise are:

- vehicles used for the transport of waste, chemicals and residues
- mechanical pretreatment of waste, e.g. shredding, baling, etc.
- exhaust fans, extracting flue-gases from the incineration process and causing noise at the outlet of the stack
- noise, related to the cooling system (from evaporative cooling, especially air cooling)
- turbine generation noise (high level so usually placed in specific sound-proofed buildings)
- boiler pressure emergency blowdowns (these require direct release to atmosphere for boiler safety reasons)
- compressors for compressed air
- noise related to the transport and treatment of bottom ash (if on the same site).

SCR systems and flue-gas ducts give rise to little noise and are often not inside buildings. Other installation parts are not usually significant for external noise production but may contribute to a general external noise production by the plant buildings.

### 1.6.4 Energy production and consumption

Waste incinerators both produce and consume energy. In a large majority of cases, the energetic value of the waste exceeds the process requirements. This may result in the net export of energy. This is often the case with municipal waste incinerators in particular.

Given the total quantities of waste arising, and its growth over many years, the incineration of waste can be seen to offer a large potential source of energy. In some MSs this energy source is already well exploited. This is particularly the case where the use of CHP is used. Energy issues are discussed in more detail later in this document (see Sections 3.5 and 4.3).

[64, TWGComments, 2003]

Figure 1.3 below shows the production of heat and electricity from municipal waste incineration plants for various countries in 1999:

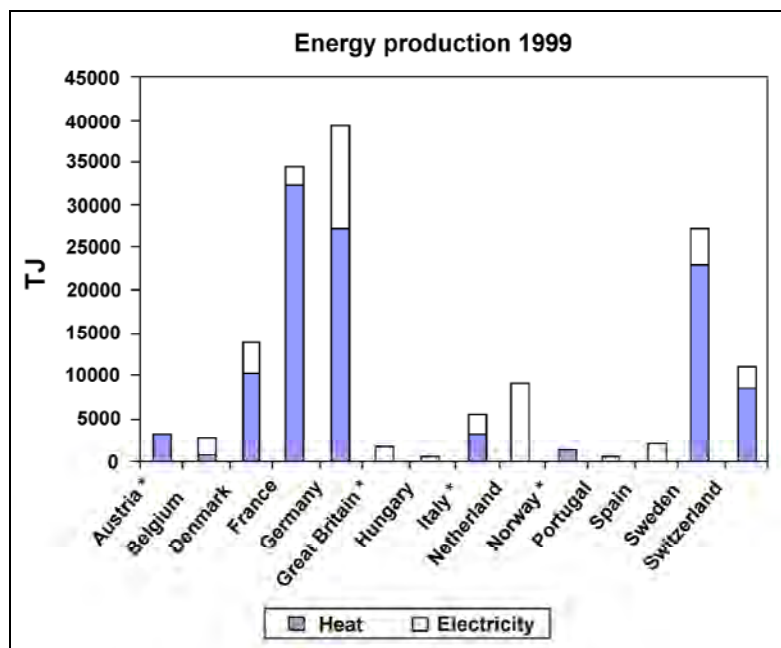

Figure 1.3: Energy production by municipal waste incinerators in Europe (1999)

\* means incomplete data [42, ISWA, 2002]

Most wastes contain biomass (to differing degrees). In such cases, the energy derived from the biomass fraction may be considered to substitute for fossil fuel and therefore the recovery of energy from that fraction be considered to contribute to a reduction in the overall carbon dioxide emissions from energy production. In some countries, this attracts subsidies and tax reductions. [64, TWGComments, 2003]

**Energy inputs** to the incineration process can include:

- waste
- support fuels, (e.g. diesel, natural gas):
  - for start-up and shutdown
  - to maintain required temperatures with lower CV wastes
  - for flue-gas reheating before treatment or release
- imported electricity:
  - for start-up and shutdown phases when all lines are stopped and for plants without electricity generation.

(Note: some of the above energy inputs contribute to steam/heat production where boilers are used and are therefore the energy is partially recovered in the process.)



**Energy production, self-consumption and export** can include:

- electricity
- heat (as steam or hot water)
- syngas (for pyrolysis and gasification plants that do not burn the syngas on site).

The efficient recovery of the energy content of the waste is generally considered to be a key issue for the industry.

[74, TWGComments, 2004]

### 1.6.5 Consumption of raw materials and energy by the installation

Waste incineration plants (process dependent) may consume the following:

- electricity, for process plant operation
  - heat, for specific process needs
  - fuels, support fuels (e.g. gas, light oils, coal, char)
  - water, for flue-gas treatment, cooling and boiler operation
  - flue-gas treatment reagents, e.g. caustic soda, lime, sodium bicarbonate, sodium sulphite hydrogen peroxide, activated carbon, ammonia, and urea
  - water treatment reagents, e.g. acids, alkalis, tri-mercapto tri-azine, sodium sulphite, etc.
  - high pressure air, for compressors.
- [74, TWGComments, 2004]

## 1.7 Economic information

[43, Eunomia, 2001] [64, TWGComments, 2003]

The economic aspects of incineration vary greatly between regions and countries, not only due to technical aspects but also depending on waste treatment policies. A study [43, Eunomia, 2001] of these aspects provided to the TWG gives information on the situation in EU MSs – some information from this study has been included in the annexe to this document.

The costs of incineration are generally affected by the following factors:

- costs of land acquisition
- scale (there may often be significant disadvantages for small scale operation)
- plant utilisation rate
- the actual requirements for the treatment of flue-gases/effluents, e.g. the imposed emission limit values can drive the selection of particular technologies that in some circumstances impose significant additional capital and operational costs
- the treatment and disposal/recovery of ash residues, e.g. bottom ash may often be used for construction purposes, in which case, the landfilling cost is avoided. The costs of treatment for fly ash varies significantly, owing to the different approaches and regulations applied regarding the need for treatment prior to recovery or disposal, and the nature of the disposal site
- the efficiency of energy recovery, and the revenue received for the energy delivered. The unit price of energy delivered, and whether revenues are received for just heat or electricity us for both are both important determinants of net costs
- the recovery of metals and the revenues received from this
- taxes or subsidies received for incineration and/or levied on emissions - direct and indirect subsidies can influence gate fees significantly i.e. in the range of 10 – 75 %
- architectural requirements
- development of the surrounding area for waste delivery access, and other infrastructure

- availability requirements, e.g. availability may be increased by doubling each pump but this imposes additional capital costs
- planning and building cost/ depreciation periods, taxes and subsidies, capital cost market
- insurance costs
- administration, personnel, salary costs.

The owners and operators of incineration plants may be municipal bodies, as well as private companies. Public/private partnerships are also common. The finance cost of capital investments may vary depending upon the ownership.

Waste incineration plants receive fees for the treatment of the waste. They can also produce and sell electricity, steam, and heat, and recover other products, such as bottom ashes for use as civil construction material, iron scrap and non-ferrous scrap for use in the metal industry, HCl, salt or gypsum. The price paid for these commodities, and the investment required to produce them, has a significant impact on the operational cost of the installation. It can also be decisive when considering specific technical investments and process designs (e.g. whether heat can be sold at a price that justifies the investment required for its supply). The prices paid for these commodities vary from one MS to another or even from one location to another.

In addition, significant differences occur due to the variations in emission requirements, salary costs and depreciation periods, etc. For these reasons, the gate fees in Table 1.8 are only comparable to a limited extent:

Member states	Gate fees in EUR/t incineration plants	
	Municipal waste	Hazardous waste
Belgium	56 – 130	100 – 1500
Denmark	40 – 70	100 – 1500
France	50 – 120	100 – 1500
Germany	100 – 350	50 – 1500
Italy	40 – 80	100 – 1000
Netherlands	90 – 180	50 – 5000
Sweden	20 – 50	50 - 2500
United Kingdom	20 – 40	Not available

**Table 1.8: Gate fees in European MSW and HW incineration plants**  
[1, UBA, 2001]

It is important not to confuse the real cost of the gate fee 'needed' in order to pay for the investment and operation, and the market price that is adopted in order to deal with competition. Competition with alternative methods of waste management (e.g. landfills, fuel production, etc.) as well as investment costs and operational expenses have an effect on the final gate fee at incineration plants. Competition prices vary greatly from one MS or location to another.

Table 1.9 shows (except where noted) the variation in municipal waste incineration costs across MSs. Note that the costs presented in Table 1.9 are different to those in Table 1.8 above (which presents data on *gate fees*):

	Pre-tax <sup>2</sup> costs net of revenues in EUR per tonne waste input	Tax (for plant with energy recovery)	Revenues from energy supply (EUR per kWh)	Costs of ash treatment (EUR per tonne of ash unless otherwise specified)
A	326 @ 60 kt/yr 159 @ 150 kt/yr 97 @ 300 kt/yr		Electricity: 0.036 Heat: 0.018	Bottom ash: 63 Flue-gas residues: 363
B	72 average	EUR 12.7/t (Flanders)	Electricity: 0.025	Not available
DK	30 – 45	EUR 44/t	Electricity: 0.05	Bottom ash: 34 Flue-gas treatment residues: 80
FIN	None		For gasification, Electricity 0.034 Heat 0.017	
F	86 - 101 @ 37.5 kt/yr 80 - 90 @ 75 kt/yr 67 - 80 @ 150 kt/yr		Electricity 0.033 - 0.046 Heat: 0.0076 - 0.023	Bottom ash: EUR 13 – 18 per tonne input
D	250 (50 kt/yr and below) <sup>1</sup> 105 (200 kt/yr) <sup>1</sup> 65 @ 600 kt/yr <sup>1</sup>		Electricity 0.015 – 0.025	Bottom ash: 25 - 30 Fly ash/air pollution control residues: 100 - 250
EL	None		Not known	Not known
IRL	None		Not known	Not known
I	41.3 – 93 (350 kt, depends on revenues for energy and packaging recovery)		Electricity: 0.14 (old) 0.04 (market) 0.05 (green cert.)	Bottom ash: 75 Fly ash and air pollution control residues: 29
L	97 (120 kt)		Electricity: 0.025 (estimated)	Bottom ash EUR 16/t input waste Flue-gas residues: EUR 8/t input waste
NL	71 – 110 <sup>1</sup> 70 – 134 <sup>1</sup>		Electricity: 0.027 - 0.04 (estimated)	
P	46 – 76 (est.)			No data
E	34 – 56		Electricity: 0.036	
S	21 – 53		Electricity: 0.03 Heat: 0.02	
UK	69 @ 100kt/yr 47 @ 200kt/yr		Electricity: 0.032	Bottom ash recycled (net cost to operator) fly ash circa 90
Notes: 1. These figures are gate fees, not costs 2. Pre-tax cost refers to gross costs without any tax.				

**Table 1.9: Comparative costs of MSW incineration in different MSs**  
[43, Eunomia, 2001, 64, TWGComments, 2003]

The following table illustrates how the capital costs of an entire new MSWI installation can vary with the flue-gas and residue treatment processes applied:

Type of flue-gas cleaning	Specific investment costs (EUR/tonne waste input/yr)			
	100 ktonnes/yr	200 ktonnes/yr	300 ktonnes/yr	600 ktonnes/yr
Dry	670	532	442	347
Dry plus wet	745	596	501	394
Dry plus wet with residue processing	902	701	587	457

**Table 1.10: Specific investment costs for a new MSWI installation related to the annual capacity and some types of FGT in Germany**  
[1, UBA, 2001], [64, TWGComments, 2003]

Table 1.11 shows some examples of average specific incineration costs (1999) for municipal waste and hazardous waste incineration plants (all new plants). The data indicates that the specific costs for incineration are heavily dependent on the financing costs of the capital and, therefore, by the investment costs and the plant capacity. Significant cost changes can occur and depend on the set-up, such as the depreciation period, interest costs, etc. Plant utilisation can also have a significant influence on the incineration costs.

Cost structure	Incineration plant for	
	Municipal waste with a capacity of 250 ktonnes/yr in EUR 10 <sup>6</sup>	Hazardous waste with a capacity of 70 ktonnes/yr in EUR 10 <sup>6</sup>
Planning/approval	3.5	6
Machine parts	70	32
Other components	28	28
Electrical works	18	20
Infrastructure works	14	13
Construction time	7	7
<b>Total investment costs</b>	<b>140</b>	<b>105</b>
Capital financing cost	14	10
Personnel	4	6
Maintenance	3	8
Administration	0.5	0.5
Operating resources/energy	3	2.5
Waste disposal	3.5	1.5
Other	1	0.5
Total operational costs	<b>29</b>	<b>12.5</b>
<b>Specific incineration costs (without revenues)</b>	<b>Approx EUR 115/tonne</b>	<b>Approx EUR 350/tonne</b>
Note: The data provides an example in order to illustrate differences between MSWI and HWI. Costs of each and the differential between them vary		

**Table 1.11: Example of the comparative individual cost elements for MSW and HW incineration plants**  
 [1, UBA, 2001], [64, TWGComments, 2003]

Energy prices:

[43, Eunomia, 2001] Revenues are received for energy sales. The level of support per kWh for electricity and/or heat generation varies greatly. For example, in Sweden and Denmark, gate fees are lower, at least in part because of the revenue gained from the sales of thermal energy as well as electricity. Indeed, in Sweden, the generation of electricity is often not implemented in the face of considerable revenues for heat recovery.

In some other countries, support for electricity production has encouraged electrical recovery ahead of heat recovery. The UK, Italy, and Spain, amongst others, have at some stage, supported incineration through elevated prices for electricity generated from incinerators.

In other MSs, the structure of incentives available for supporting renewable energy may also affect the relative prices of alternative waste treatments and hence competition prices.

The potential revenues from energy sales at waste incineration facilities constitute an incentive for all concerned parties to include energy outlets in the planning phase for incineration facilities [64, TWGComments, 2003].

Revenues received for recovery of packaging materials:

[43, Eunomia, 2001] These have also influenced relative prices. For example, in Italy and the UK, incinerators have received revenues associated with the recovery of packaging material.

It should be noted that, legislative judgements concerning recovery and disposal may influence whether incinerators can legally benefit from these revenues [64, TWGComments, 2003]

Taxes on incineration:

[43, Eunomia, 2001] In Denmark, the tax on incineration is especially high. Hence, although underlying costs tend to be low (owing primarily to scale, and the prices received for energy), the costs net of tax are of the same order as that of several other countries where no tax is in place. This tax along with a landfill tax were adopted in Denmark to promote waste treatment in compliance with the waste hierarchy. This has resulted in a large shift from landfill to recycling, but with the percentage of waste being incinerated remaining constant [64, TWGComments, 2003].



## 2 APPLIED TECHNIQUES

### 2.1 Overview and introduction

The basic linear structure of a waste incineration plant may include the following operations. Information describing these stages is included later in this chapter:

- incoming waste reception
- storage of waste and raw materials
- pretreatment of waste (where required, on-site or off-site)
- loading of waste into the process
- thermal treatment of the waste
- energy recovery (e.g. boiler) and conversion
- flue-gas cleaning
- flue-gas cleaning residue management (from flue-gas treatment)
- flue-gas discharge
- emissions monitoring and control
- waste water control and treatment (e.g. from site drainage, flue-gas treatment, storage)
- ash/bottom ash management and treatment (arising from the combustion stage)
- solid residue discharge/disposal.

Each of these stages is generally adapted in terms of design, for the type(s) of waste that are treated at the installation.

Many installations operate 24h/day, nearly 365 days/yr. Control systems and maintenance programmes play an important role in securing the availability of the plant. [74, TWGComments, 2004]

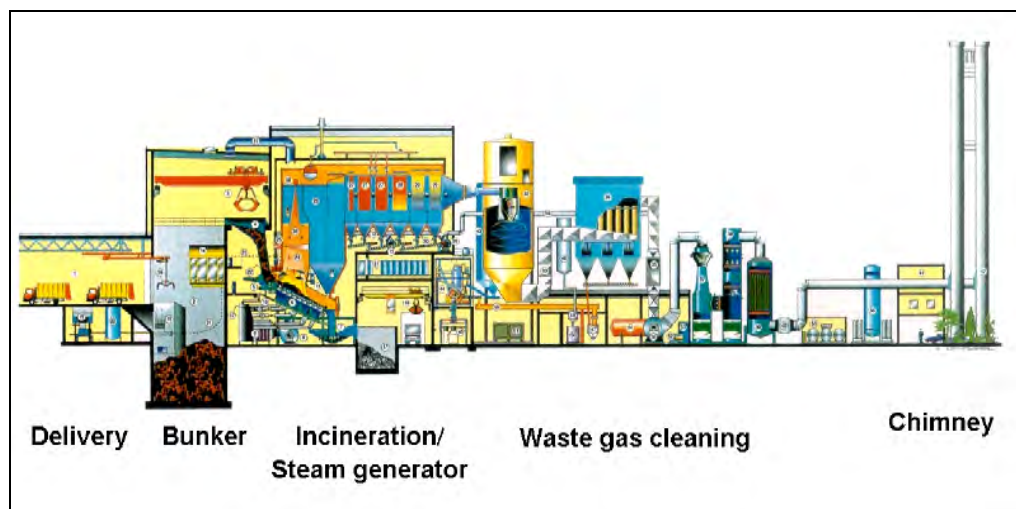

Figure 2.1: Example layout of a municipal solid waste incineration plant [1, UBA, 2001]

In the example shown above (Figure 2.1), the incoming waste storage and handling stages are on the left of the diagram, before the incineration stage. The flue-gas cleaning system is shown labelled as *waste gas cleaning*, to the right of the furnace and boiler. The example shown is a wet FGT system with several unit operations. Other modern installations use FGT systems with fewer process units.

Although incineration is by far the most widely applied, there are three main types of thermal waste treatment relevant to this BREF:

- **pyrolysis** - thermal degradation of organic material in the absence of oxygen
- **gasification** - partial oxidation
- **incineration** - full oxidative combustion.

The reaction conditions for these thermal treatments vary, but may be differentiated approximately as follows:

	<b>Pyrolysis</b>	<b>Gasification</b>	<b>Combustion</b>
<b>Reaction temperature (°C)</b>	250 – 700	500 – 1600	800 - 1450
<b>Pressure (bar)</b>	1	1 – 45	1
<b>Atmosphere</b>	Inert/nitrogen	Gasification agent: O <sub>2</sub> , H <sub>2</sub> O	Air
<b>Stoichiometric ratio</b>	0	<1	>1
<b>Products from the process</b>			
<b>Gas phase:</b>	H <sub>2</sub> , CO, hydrocarbons, H <sub>2</sub> O, N <sub>2</sub>	H <sub>2</sub> , CO, CO <sub>2</sub> , CH <sub>4</sub> , H <sub>2</sub> O, N <sub>2</sub>	CO <sub>2</sub> , H <sub>2</sub> O, O <sub>2</sub> , N <sub>2</sub>
<b>Solid phase:</b>	Ash, coke	Slag, ash	Ash, slag
<b>Liquid phase:</b>	Pyrolysis oil and water		

**Table 2.1: Typical reaction conditions and products from pyrolysis, gasification and incineration processes**  
Adapted from [9, VDI, 2002]

Pyrolysis and gasification plants follow a similar basic structure to waste incineration installations, but differ significantly in detail. The main differences are as follows:

- **pretreatment**, may be more extensive to provide a narrow profile feedstock. Additional equipment is required for handling/treating/storing the rejected material
- **loading**, greater attention required to sealing
- **thermal reactor**, to replace (or in addition to) the combustion stage
- **product handling**, gaseous and solid products require handling, storage and possible further treatments
- **product combustion**, may be a separate stage and include energy recovery by combustion of the products and subsequent gas/water/solid treatments and management.

## 2.2 Pretreatment, storage and handling techniques

The different types of wastes that are incinerated may need different types of pretreatment, storage and handling operations. This section is organised in such a way that it describes in order the most relevant of these operations for each type of waste, in particular for:

- municipal solid wastes
- hazardous wastes
- sewage sludge
- clinical wastes.



## 2.2.1 Municipal solid wastes (MSW)

### 2.2.1.1 Collection and pretreatment outside the MSW incineration plant

Although beyond the immediate scope of this BREF document, it is important to recognise that the local collection and pretreatment applied to MSW can influence the nature of the material received at the incineration plant. The requirements concerning the pretreatment and other operations should therefore be consistent with the collection system in place.

Recycling schemes may mean that some fractions have been removed. Their effect will be approximately as follows:

Fraction removed	Prime impacts on remaining waste
Glass and metals	<ul style="list-style-type: none"> <li>increase in calorific value</li> <li>decrease in quantity of recoverable metals in slag</li> </ul>
Paper, card and plastic	<ul style="list-style-type: none"> <li>decrease in calorific value</li> <li>possible reduction in chlorine loads if PVC common</li> </ul>
Organic wastes, e.g. food and garden wastes	<ul style="list-style-type: none"> <li>reduction in moisture loads (particularly of peak loads)</li> <li>increase in net calorific value</li> </ul>
Bulky wastes	<ul style="list-style-type: none"> <li>reduced need for removal/shredding of such wastes</li> </ul>
Hazardous wastes	<ul style="list-style-type: none"> <li>reduction in hazardous metal loading</li> <li>reduction in some other substances e.g. Cl, Br, Hg</li> </ul>

**Table 2.2: Prime impact of waste selection and pretreatment on residual waste**  
[74, TWGComments, 2004]

One study assessing the effect of selective collection on the remaining household (called "grey waste") gave the following conclusions:

- glass collection decreased the throughput (-13 %) and increased the NCV (+15 %) of the residual "grey waste"
  - packaging and paper collection decreased the throughput (-21 %) and decreased the NCV (-16 %) of the "grey waste"
  - in general, throughput and NCV of the "grey waste" decreased when the efficiency of the selective collection increased. The maximum impact of selective collection was -42 % for the throughput and -3 % for the NCV of the "grey waste"
  - selective collection had an effect on the grey waste quality - it increased significantly the content of the fine element, which can be particularly rich in heavy metals (fines increased from 16 % to 33 %)
  - bottom ash ratio decreased due to selective collection (-3 %).
- [74, TWGComments, 2004]

The degree to which separate collection and similar schemes effect the final waste delivered to the installation are seen depends on the effectiveness of the separation and pretreatment systems employed. This varies greatly. Some residual fractions are always likely to remain in the delivered waste.

Reject materials from recycling plants, monofractions of waste, commercial and industrial wastes, and some hazardous wastes may also be found in the delivered waste.

### 2.2.1.2 Municipal solid waste pretreatment within the incineration plant

In-bunker mixing is commonly used to blend MSW. This usually consists of using the same waste grab that is also used for hopper loading. Most commonly, the pretreatment of MSW is limited to the shredding of pressed bales, bulky waste, etc, although sometimes more extensive shredding is used. The following equipment is used:

- crocodile shears
- shredder
- mills
- rotor shears.

For fire-safety reasons, the following arrangements may be used:

- separation of the dumping areas from the storage in the bunker
- separation of hydraulic plants (oil supply, pump- and supply equipment) from the cutting tools
- collection devices for leaked oil
- decompression release in the housings to reduce explosion damage.

It is generally necessary to pretreat (i.e. crush) bulky waste when its size is greater than that of the feed equipment to the furnace. Another reason for pretreatment is to homogenise the waste so that it has more consistent combustion characteristics (e.g. for some wastes with high NCVs). This may be achieved by mixing, crushing or shredding the waste.

Additional waste pretreatment is unusual for grate furnace plants, but may be essential for other furnace designs.

### 2.2.1.3 Waste delivery and storage

#### 2.2.1.3.1 Waste control

The waste delivery area is the location where the delivery trucks, trains, or containers arrive in order to dump the waste into the bunker, usually after visual control and weighing. The dumping occurs through openings between the delivery area and the bunker. Tilting and sliding beds may be used to help waste transfer to the bunker. The openings can be locked, and therefore also serve as odour and seal locks, as well as fire and crash-protecting devices. Enclosure of the delivery area can be one effective means of avoiding odour, noise and emission problems from the waste.

#### 2.2.1.3.2 Bunker

The bunker is usually a waterproof, concrete bed. The waste is piled and mixed in the bunker using cranes equipped with grapples. The mixing of wastes helps to achieve a balanced heat value, size, structure, composition, etc. of the material dumped into the incinerator filling hoppers.

Fire protection equipment is used in the bunker area and feeder system. For example:

- fire proofed cabling for the cranes
- safety design for the crane cabs
- fire detectors
- automatic water cannon sprays, with or without foam.

Crane cabs are designed in such a way that the crane operator has a good overview of the entire bunker. The cab has its own ventilation system, independent from the bunker.

In order to avoid excessive dust development and gas formation (e.g. methane) from fermenting processes, as well as the accumulation of odour and dust emissions, the primary incineration air for the furnace plants is often extracted from the bunker area. Depending on the calorific value of the waste as well as the layout and the concept of the plant, preference is most often given to supplying the bunker air to either the primary or secondary air. [74, TWGComments, 2004]

The bunker usually has a storage capacity of several days (commonly 3 - 5 days) of plant operational throughput. This is very dependent on local factors and the specific nature of the waste.

Additional safety devices may be implemented such as: dry standpipe at the waste hopper level, foam nozzle above waste hopper, fire detection for the hydraulic group, fire resistant walls between the bunker and the furnace hall, fire resistant walls between the furnace hall and the control room, water curtains on the window between the control room and the furnace, smoke and fire extraction (5 - 10 % of the surface of the roof) etc. [74, TWGComments, 2004]

## **2.2.2 Hazardous wastes**

### **2.2.2.1 Brief description of the sector**

The hazardous waste incineration sector comprises two main sub-sectors:

- merchant incineration plants
- dedicated incineration plants.

The main differences between these are summarised in the table below:

Criteria	Merchant plants	Dedicated plants
<b>Ownership</b>	Private companies, municipalities or partnerships	Usually private companies (used for their own wastes)
<b>Characteristics of wastes treated</b>	<ul style="list-style-type: none"> <li>• very wide range of wastes</li> <li>• knowledge of exact waste composition may be limited in some cases.</li> </ul>	<ul style="list-style-type: none"> <li>• wide range of wastes</li> <li>• often only the waste arising within one company or even from one process</li> <li>• knowledge of waste composition generally higher.</li> </ul>
<b>Combustion technologies applied</b>	<ul style="list-style-type: none"> <li>• predominantly rotary kilns</li> <li>• some dedicated technologies for dedicated or restricted specification wastes.</li> </ul>	<ul style="list-style-type: none"> <li>• rotary kilns plus</li> <li>• a wide variety of specific techniques for dedicated or restricted specification wastes.</li> </ul>
<b>Operational and design considerations</b>	<ul style="list-style-type: none"> <li>• Flexibility and wide range of performance required to ensure good process control.</li> </ul>	<ul style="list-style-type: none"> <li>• Process can be more closely designed for a narrower specification of feed in some cases.</li> </ul>
<b>Flue-gas treatment</b>	<ul style="list-style-type: none"> <li>• wet scrubbing often applied to give flexibility of performance, as well as</li> <li>• a range of FGT techniques applied in combination.</li> </ul>	<ul style="list-style-type: none"> <li>• wet scrubbing often applied to give flexibility of performance, as well as</li> <li>• a range of FGT techniques applied in combination.</li> </ul>
<b>Cost/market considerations</b>	<ul style="list-style-type: none"> <li>• operators usually compete in an open (global) market for business</li> <li>• some plants benefit from national/regional policies regarding the destination of wastes arising in that country/region.</li> <li>• Movement of hazardous waste in the EU is controlled by Transfrontier Shipment Regulations which limits the scope of open global market.</li> </ul>	<ul style="list-style-type: none"> <li>• competition more limited or in some cases non-existent</li> <li>• higher disposal costs tolerated by users in some cases for reasons of waste producer policy on in-house disposal.</li> </ul>

**Table 2.3: Summary of the differences between operators in the HWI market**

Source: discussions with TWG

[EURITS, 2002 #41]. The individual incineration capacity of rotary kilns used in the merchant sector varies between 30000 and 100000 tonnes a year. The mass capacity for an individual design varies considerably with the average calorific value of the waste, with the principal factor being thermal capacity.

The following sections refer mainly to the delivery, storage and pretreatment of hazardous waste for the merchant sector.

### 2.2.2.2 Waste acceptance

Due to the very wide variety of wastes encountered, their high potential hazard, and elevated uncertainties over the precise knowledge of the waste composition, significant effort is required to assess, characterise and trace incoming wastes through the entire process. The systems adopted need to provide a clear audit trail that allows the tracing of any incidents to their source. This then enables procedures to be adapted to prevent incidents.

The exact procedures required for waste acceptance and storage depends on the chemical and physical characteristics of the waste.

#### Identification and analysis of wastes:

[1, UBA, 2001] For each type of hazardous waste, a declaration of the nature of the waste made by the waste producer is submitted so that the waste manager can then decide whether the treatment of each specific type of waste is possible. Such a declaration may include:

- data on the waste producer and responsible persons
- data on the waste code and other designations for the waste
- data on the origin of the waste
- analytical data on particular toxic materials
- general characteristics, including combustion parameters, such as: Cl, S, calorific value, water content, etc.
- other safety/environmental information
- legally-binding signature
- additional data upon request of the accepting plant.

Some types of waste require additional measures. Homogeneous, production-specific waste can often be adequately described in general terms. Additional measures are usually required for waste of less well-known composition (e.g. waste from refuse dumps or from the collections of hazardous household waste), including the investigation of each individual waste container.

When the waste composition cannot be described in detail (e.g. small amounts of pesticides or laboratory chemicals), the waste management company may agree with the waste producer on specific packaging requirements, making sure that the waste will not react during transport, when it is accepted for incineration, or within containers. For example, risks may arise from:

- wastes with phosphides
- wastes with isocyanates
- wastes with alkaline metals (e.g., or other reactive metals)
- cyanide with acids
- wastes forming acid gases during combustion
- wastes with mercury.

[74, TWGComments, 2004]

Delivered wastes generally undergo specific admission controls, whereby the previously received declaration by the waste producer provides the starting point. After comparison by visual and analytical investigations with the data contained in the declaration, the waste is either accepted, allocated to the appropriate storage area, or rejected in the case of significant deviations.

#### **2.2.2.3 Storage**

The general principles of storage are described in the BREF on emissions from storage. However, this section serves to outline some issues that are specific to the hazardous waste industry.

In general, the storage of wastes needs, additionally, to take into account the unknown nature and composition of wastes, as this gives rise to additional risks and uncertainties. In many cases, this uncertainty means that higher specification storage systems are applied for wastes than for well-characterised raw materials.

A common practice is to ensure, as far as possible, that hazardous wastes are stored in the same containers (drums) that are used for transport; thus avoiding the need for additional handling and transfer. Good communication between the waste producer and the waste manager help to ensure wastes are stored, transferred, etc, such that risks all along the chain are well managed. It is also important that only well characterised and compatible wastes are stored in tanks or bunkers.

For hazardous waste incineration, storage arrangements for some substances may need to be consistent with the COMAH/(Seveso II) requirements, as well as BAT described in the storage BREF. There may be circumstances where the *major accident and hazard* (MAH) prevention/mitigation measures take precedence.

[EURITS, 2002 #41] Appropriate waste assessment is an essential element in the selection of storage and loading options. Some issues to note are:

- for the storage of **solid hazardous waste**, many incinerators are equipped with a bunker (500 to 2000 m<sup>3</sup>) from where the waste is fed into the installation by cranes or feed hoppers
- **liquid hazardous waste and sludges**, these are usually stored in a tank farm. Some tanks have storage under an inert (e.g. N<sub>2</sub>) atmosphere. Liquid waste is pumped via pipelines to the burners and introduced into the rotary kiln and/or the post combustion chamber (PCC). Sludges can be fed to rotary kilns using special “viscous-matter” pumps
- some incinerators are able to feed certain substances, such as toxic, odorous, reactive and corrosive liquids, by means of a **direct injection** device, directly from the transport container into either the kiln or PCC
- almost half of the merchant incinerators in Europe are equipped with conveyors and elevators to transport and introduce **drums** and/or small packages (e.g. lab packs) directly into the rotary kiln. These may be via air locks systems, and can use inert gas flood systems.

### 2.2.2.3.1 Storage of solid hazardous waste

[1, UBA, 2001] Solid and unpumpable pasty hazardous waste that has not been degassed and does not smell, is stored temporarily in bunkers. Storage and mixing areas can be separated in the bunker. This can be achieved through several design segments. Cranes feed both solid and pasty waste products. The bunker must be designed in such a way that ground emissions can be prevented.

The bunker and container storage must be enclosed unless health and safety reasons (danger of explosion and fire) exist. The air in the bunker is usually removed and used as incineration air. In anticipating fires, monitors such as heat-detecting cameras are used, in addition to constant monitoring by personnel (control room, crane operator).

### 2.2.2.3.2 Storage of pumpable hazardous waste

[1, UBA, 2001] Larger amounts of fluid and pumpable pasty wastes are temporarily stored in tanks that must be available in sufficient numbers and sizes to accommodate reacting liquids separately (danger of explosion, polymerisation).

Tanks, pipelines, valves, and seals must be adapted to the waste characteristics in terms of construction, material selection, and design. They must be sufficiently corrosion-proof, and offer the option of cleaning and sampling. Flat bed tanks are generally only deployed for large loads.

It may be necessary to homogenise the tank contents with mechanical or hydraulic agitators. Depending on the waste characteristics, the tanks must be heated indirectly and insulated. Tanks are set in catch basins that must be designed for the stored material, with bund volumes chosen so that they can hold the liquid waste in the event of leakage.

### 2.2.2.3.3 Storage for containers and tank containers

[1, UBA, 2001] For safety reasons, hazardous waste is most often accumulated in special containers. These containers are then delivered to the incineration plant. Delivery is also taken of bulk liquids.

The delivered containers may be stored or the contents transferred. In some cases, according to a risk assessment, the waste may be directly injected via a separate pipeline into the furnace. Heated transfer lines may be used for wastes that are only liquid at higher temperatures.

Storage areas for containers and tank containers are usually located outside, with or without roofs. Drainage from these areas is generally controlled, as contamination may arise.

### 2.2.2.4 Feeding and pretreatment

Because of the wide range of chemical and physical specification of some hazardous wastes, difficulties may occur in the incineration process. Some degree of waste blending or specific pretreatment is thus often carried out in order to achieve more even loads.

[2, infomil, 2002] It is also necessary for acceptance criteria to be developed for each installation. Such a recipe will describe the range of concentrations within which key combustion and chemical waste characteristics should be maintained, in order to ensure the process runs predictably, to prevent exceeding the process capacity, and thus to comply with operational and environmental (e.g. permit conditions) requirements.

Factors that set such ranges include:

- the flue-gas cleaning technology capacity for individual pollutants (e.g. scrubber flowrates, etc)
- the existence or absence of a particular flue-gas cleaning technique
- emission limit values required
- heat throughput rating of the furnace
- design of the waste feed mechanism and the physical suitability of the waste received.

[EURITS, 2002 #41] Some incinerators have dedicated and **integrated homogenisation installations** for the pretreatment of waste. These include:

- a shredder for bulky solids (e.g. contaminated packages) [74, TWGComments, 2004]
- a dedicated shredder purely for drums. Depending on the installation, drums containing solid and/or liquid waste can be treated. The shredded residues are then fed via the bunker and/or tanks
- a shredder combined with a mechanical mixing device. This results in a homogenised fraction which is pumped directly into the kiln by means of a thick-matter pump. Some shredders can deal with both drums and/or solid waste in packages of up to one tonne.

Depending on the waste composition and the individual characteristics of the incineration plant, together with the availability of other treatment means for any wastes produced, other pretreatment may also be carried out. For example [1, UBA, 2001]:

- neutralisation (for waste acceptance, pH-values from 4 - 12 are normal)
- sludge drainage
- solidification of sludge with binding agents.

The following figure shows an example of some hazardous waste pretreatment systems used at some merchant HWI:

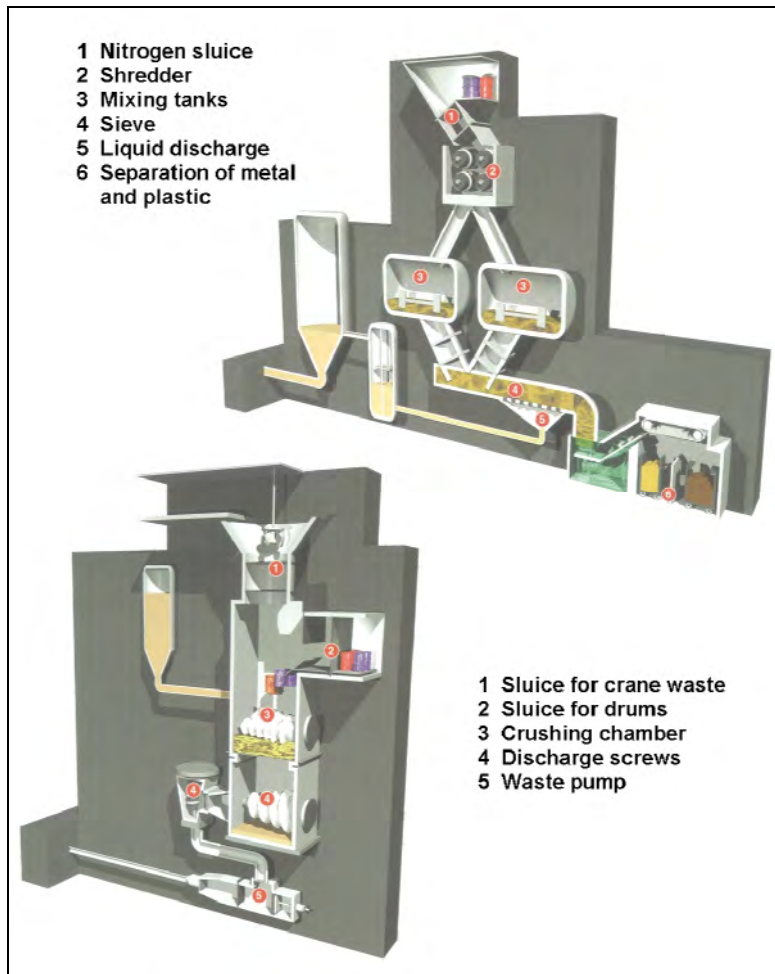

Figure 2.2: Example of some hazardous waste pretreatment systems used at some merchant HWI [25, Kommunikemi, 2002]

## 2.2.3 Sewage sludge

### 2.2.3.1 Composition of sewage sludge

The composition of sewage sludge varies according to many factors, including:

- system connections, e.g. industrial inputs can increase heavy metal loads
- coastal locations, e.g. for salt water inclusion
- treatments carried out at the treatment works, e.g. crude screening only, anaerobic sludge digestion, aerobic sludge digestion, addition of treatment chemicals
- weather/time of year, e.g. rainfall can dilute the sludge.



The composition of sewage sludge varies greatly. Typical composition ranges for dewatered communal and industrial sewage sludge are given below:

Component	Communal sewage sludge	Industrial sewage sludge
Dry solids (%)	10 – 45	-
Organic material (% of dry solids)	45 – 85	-
Heavy metals mg/kg d.s.):	-	-
Cr	20 – 77	170
Cu	200 – 600	1800
Pb	100 – 700	40
Ni	15 – 50	170
Sb	1 – 5	<10
Zn	500 – 1500	280
As	5 – 20	<10
Hg	0.5 – 4.6	1
Cd	1 – 5	<1
Mo	4 – 20	-

**Table 2.4: Average composition of dewatered communal sewage sludge after dewatering** [2, infomil, 2002], [64, TWGComments, 2003]

Particularly important factors to take into account when incinerating sewage sludges are:

- the dry solids content (typically this varies from 10 % up to 45 % - this can have a major impact on the incineration process)
- whether the sludge is digested or not
- the lime, limestone and other conditioning contents of the sludge
- The composition of the sludge as primary-, secondary-, bio-sludge, etc.
- Odour problems, especially during sludge feeding in the storage. [64, TWGComments, 2003] [74, TWGComments, 2004]

### 2.2.3.2 Pretreatment of sewage sludge

#### 2.2.3.2.1 Physical dewatering

[1, UBA, 2001, 64, TWGComments, 2003]

Mechanical drainage before incineration reduces the volume of the sludge mixture, by the reduction of the water content. An increase in the heat value is associated with this process. This allows independent and economical incineration. The success of mechanical drainage depends on the selected machines, the conditioning carried out, and the type and composition of the sludge.

Through mechanical drainage of the sewage sludge in decanters, centrifuges, belt filter presses and chamber filter presses, a dry solids (DS) level of between 10 and 45 % can be achieved.

Often the sludge is conditioned before the mechanical drainage to improve its drainage. This is achieved with the help of additives that contain flock building materials. It is necessary to differentiate between inorganic flocking substances (iron and aluminium salts, lime, coal, etc.) and organic flocking substances (organic polymers). Inorganic substances not only act as flocking substances but are also builders, i.e. they increase the inorganic content substantially, and hence the unburned proportion of the drained sludge (ash). For this reason, mostly organic conditioning substances are used in the treatment of sewage sludge.

### 2.2.3.2.2 Drying

[1, UBA, 2001, 64, TWGComments, 2003]

Often a substance that has been dried by mechanical drainage is still insufficiently dry for auto thermal incineration. In this case, a thermal drying plant for additional drying can be used before the incineration furnace. In this case, the sewage sludge is further reduced in volume and the heat value is further increased.

The drying/dewatering of sewage sludge is carried out in separate or connected drying plants. The following dryer plants are utilised:

- disk dryer
- drum dryer
- fluidised bed dryer
- belt dryer
- thin film dryer/disk dryer
- cold air dryer
- thin film dryer
- centrifugal dryer
- solar dryer
- combinations of different types.

Drying processes can be divided, in principal, into two groups:

- partial drying, up to approximately 60 - 80 % d.s.
- complete drying, up to approximately 80 - 90 % d.s.

[74, TWGComments, 2004]

An alternative to external drying is the *in-situ* drying of sludge by incineration together with higher calorific waste. In such cases, the water from the dewatered sludge helps to prevent the otherwise possible high temperature peaks that can be seen if only high CV waste were incinerated.

For auto thermal incineration in mono-sewage sludge incineration plants, the drainage of raw sewage up to a dry substance content of 35 per cent is generally sufficient. This can be achieved by mechanical dewatering and may not require thermal drying.

The required dry substance content for auto thermal incineration in a given installation will depend on the composition of the sludge (energy content of the dry solids, largely related to the content of organic material). This is influenced by the nature of the sludge as such, but also by the applied pretreatment, e.g. by sludge digestion, or by the use of organic or inorganic sludge conditioners.

For the simultaneous incineration of sewage sludge with other waste streams in municipal waste incineration plants (typically with a mixture ratio of drained sewage sludge to municipal waste of max. 10 % weight of drained sewage sludge (i.e. dryness of 20 – 30 %), additional sludge drying may be required. [74, TWGComments, 2004]

The heat required for the drying process is usually extracted from the incineration process. In some drying processes, the sewage sludge to be dried comes into direct contact with the thermal carrier, e.g. in *convection dryers or direct dryers* (e.g. belt, double-deck, fluidised bed dryers). During the drying process, vapour is produced that is a mixture of steam, air, and released gases from the sludge; and hot gases are produced in the direct drying process. The vapour and gas mixture must be cleaned. Generally, the steam from the drying process is injected in the furnace. Direct dryers can be used in an indirect system by the recirculation of evaporation vapours. This system has clear advantages and is often used (but hardly or not in combination with sludge incineration).

In indirect drying systems (e.g. worm, disk, thin film dryers), the heat is injected via steam generators or thermal oil plants and the heating fluid is not in contact with the sludge. Heat transfer occurs between the wall and the sludge.

Contact dryers generally achieve a dry solids level of 35 - 40 %. The evaporated water produced through the drying process is only contaminated with leaking air and small amounts of volatile gases. The steam can be condensed almost totally from the vapour and the remaining inert gases can be deodorised in the boiler furnace. The treatment of the condensate may be complicated due to the presence of  $\text{NH}_4\text{OH}$ , TOC, etc.

### **2.2.3.2.3 Sludge digestion**

Sludge digestion decreases the content of organic material in the sludge and produces biogas (at least in the case of anaerobic digestion). Digested sludge can generally be dewatered more easily than non-digested sludge, thus allowing a slightly higher dry solids content after mechanical dewatering.

[64, TWGComments, 2003]

## **2.2.4 Clinical waste**

### **2.2.4.1 Nature and composition of clinical wastes**

Special attention is required when dealing with clinical wastes to manage the specific risks of these wastes (e.g. infectious contamination, needles, etc.), the aesthetic standards (residues of operations etc.) and their incineration behaviour (very variable calorific value and moisture contents).

Specific clinical waste often contains materials with very high NCVs (plastics, etc.), but also residues with very high water contents (e.g. blood, etc.). Clinical waste therefore usually requires long incineration times to ensure thorough waste burnout and that the residue quality is good.

Similar to hazardous wastes, the composition of specific clinical wastes varies greatly. Clinical waste may include (to varying degrees):

- infectious agents
- contaminated clothing/wipes and swabs
- pharmaceutical substances
- sharp materials, e.g. hypodermic needles
- veterinary wastes
- body parts
- used medical equipment
- packaging materials
- laboratory wastes
- radioactive contaminated materials.

In some cases a distinction is made between the incineration routes for pathological (potentially infectious waste) and non-pathological waste. The treatment of pathological waste is sometimes restricted to dedicated incinerators, while non-pathological waste is, in some cases, incinerated with other wastes in non-dedicated incinerators e.g. MSWI.

### 2.2.4.2 Handling, pretreatment and storage of clinical waste

The risks associated with the handling of clinical waste can generally be reduced by limiting the contact with the waste and by ensuring good storage, e.g. through the use of:

- dedicated containers and the provision of washing/disinfection facilities
- sealed and robust combustible containers, e.g. for sharps and biological hazard materials
- automatic furnace loading systems, e.g. dedicated bin lifts
- segregated storage and transfer areas (especially where co-incineration with other wastes takes place)
- refrigerated or freezer storage, if required.

Pretreatment may be carried out using:

- steam disinfection, e.g. autoclaving at elevated temperature and pressure
- boiling with water.

Each of these may allow the waste to be sufficiently sterilised to permit its subsequent handling in a similar manner to municipal wastes. Work and storage areas are usually designed to facilitate disinfection.

Appropriate cleaning and disinfection equipment are usually installed for the cleaning of returnable containers. The solid wastes from disinfection are collected for disposal. The waste water from disinfection are collected, and are then recycled in the incineration process (e.g. in the FGT or with the fed waste) or treated and discharged. [74, TWGComments, 2004]

Pretreatment may be applied to improve the homogeneity of the waste, such as shredding or maceration, although safety aspects require careful consideration with some clinical wastes.

Clinical waste is also incinerated in hazardous waste and other incineration plants with other types of waste. If incineration does not take place immediately, the wastes require temporary storage. In some cases, where it is necessary for clinical waste to be stored for longer than 48 hours, the waste is kept in cooled storage areas with a restricted maximum temperature (e.g. +10 °C).

## 2.3 The thermal treatment stage

Different types of thermal treatments are applied to the different types of wastes, however not all thermal treatments are suited to all wastes. This chapter and Table 2.5 review the concepts and applications behind the most common technologies, in particular:

- grate incinerators
- rotary kilns
- fluidised beds
- pyrolysis and gasification systems.

As well as some other more specific technologies.  
[EGTEI, 2002 #6]

**Municipal solid waste** - can be incinerated in several combustion systems including travelling grate, rotary kilns, and fluidised beds. Fluidised bed technology requires MSW to be of a certain particle size range– this usually requires some degree of pretreatment and/or the selective collection of the waste.

**Incineration of sewage sludge** - this takes place in rotary kilns, multiple hearth, or fluidised bed incinerators. Co-combustion in grate-firing systems, coal combustion plants and industrial processes is also applied. Sewage sludge often has a high water content and therefore usually requires drying, or the addition of supplementary fuels to ensure stable and efficient combustion.

**Incineration of hazardous and medical waste** - rotary kilns are most commonly used, but grate incinerators (including co-firing with other wastes) are also sometimes applied to solid wastes, and fluidised bed incinerators to some pretreated materials. Static furnaces are also widely applied at on-site facilities at chemical plants.

**Other processes** have been developed that are based on the de-coupling of the phases which also take place in an incinerator: drying, volatilisation, pyrolysis, carbonisation and oxidation of the waste. Gasification using gasifying agents such as, steam, air, carbon-oxides or oxygen is also applied. These processes aim to reduce flue-gas volumes and associated flue-gas treatment costs. Some of these developments met technical and economical problems when they were scaled-up to commercial, industrial sizes, and are therefore pursued no longer. Some are used on a commercial basis (e.g. in Japan) and others are being tested in demonstration plants throughout Europe, but still have only a small share of the overall treatment capacity when compared to incineration.

Technique	Untreated Municipal waste	Pretreated MSW and RDF	Hazardous waste	Sewage sludge	Clinical waste
<b>Grate - reciprocating</b>	<b>Widely applied</b>	<b>Widely Applied</b>	Not normally applied	Not normally applied	Applied
<b>Grate - travelling</b>	Applied	Applied	Rarely applied	Not normally applied	Applied
<b>Grate - rocking</b>	Applied	Applied	Rarely applied	Not normally applied	Applied
<b>Grate - roller</b>	Applied	<b>Widely Applied</b>	Rarely applied	Not normally applied	Applied
<b>Grate - water cooled</b>	Applied	Applied	Rarely applied	Not normally applied	Applied
<b>Grate plus rotary kiln</b>	Applied	Not normally applied	Rarely applied	Not normally applied	Applied
<b>Rotary kiln</b>	Not normally applied	Applied	<b>Widely applied</b>	Applied	<b>Widely applied</b>
<b>Rotary kiln - water cooled</b>	Not normally applied	Applied	applied	Applied	applied
<b>Static hearth</b>	Not normally applied	Not normally applied	Applied	Not normally applied	<b>Widely applied</b>
<b>Static furnace</b>	Not normally applied	Not normally applied	<b>Widely applied</b>	Not normally applied	Applied
<b>Fluid bed - bubbling</b>	Rarely applied	Applied	Not normally applied	applied	Not normally applied
<b>Fluid bed - circulating</b>	Rarely applied	Applied	Not normally applied	<b>Widely applied</b>	Not normally applied
<b>Fluid bed - rotating</b>	Applied	Applied	Not normally applied	Applied	Applied
<b>Pyrolysis</b>	Rarely applied	Rarely applied	Rarely applied	Rarely applied	Rarely applied
<b>Gasification</b>	Rarely Applied	Rarely applied	Rarely applied	Rarely applied	Rarely applied
Note: This table only considers the application of the technologies described at dedicated installations. It does not therefore include detailed consideration of the situations where more than one type of waste is processed.					

**Table 2.5: Summary of the current successful application of thermal treatment techniques to the main waste types at dedicated installations [64, TWGComments, 2003]**

### 2.3.1 Grate incinerators

Grate incinerators are widely applied for the incineration of mixed municipal wastes. In Europe approximately 90 % of installations treating MSW use grates. Other wastes commonly treated in grate incinerators, often as additions with MSW, include: commercial and industrial non-hazardous wastes, sewage sludges and certain clinical wastes.

Grate incinerators usually have the following components:

- waste feeder
- incineration grate
- bottom ash discharger
- incineration air duct system
- incineration chamber
- auxiliary burners.

Figure 2.3 shows an example of a grate incinerator with a heat recovery boiler:

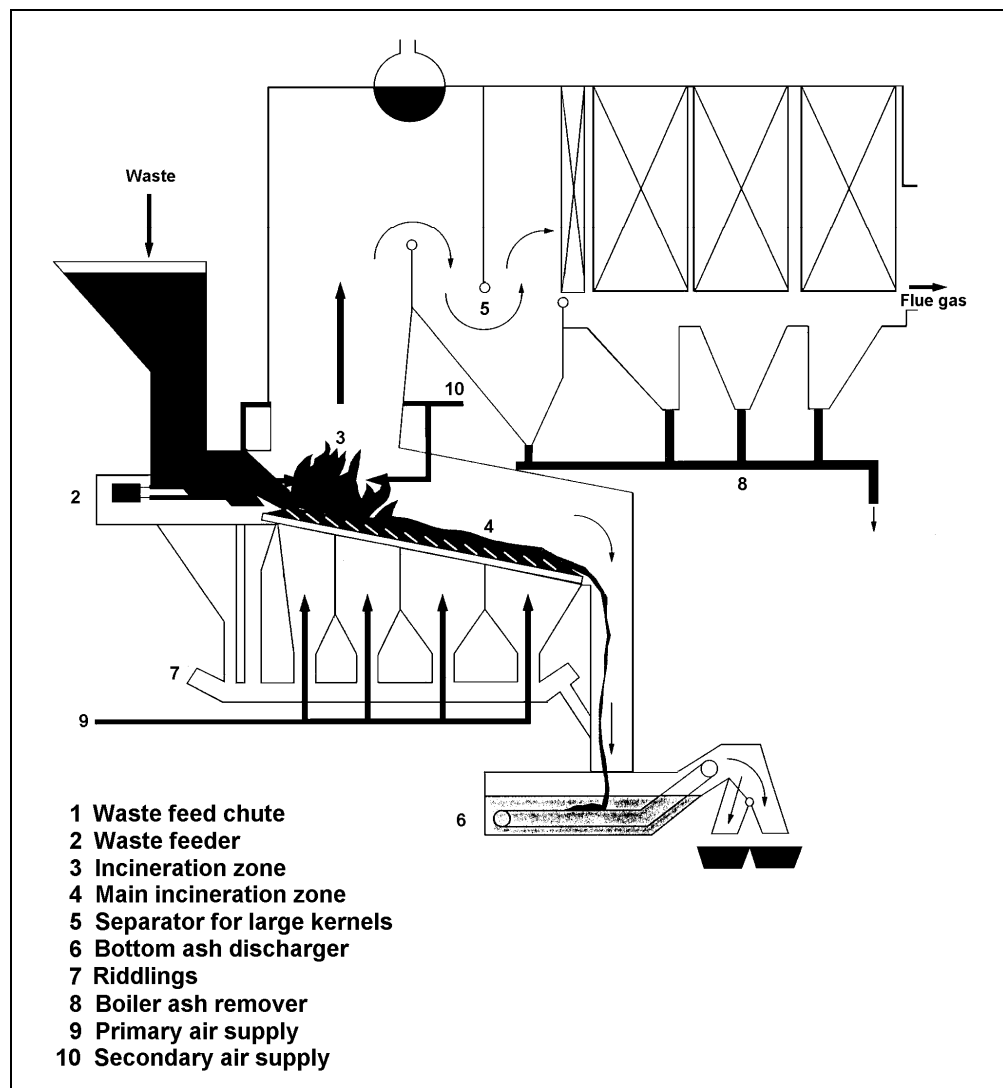

Figure 2.3: Grate, furnace and heat recovery stages of an example municipal waste incineration plant

Source [1, UBA, 2001]

### 2.3.1.1 Waste feeder

The waste is discharged from the storage bunker into the feeding chute by an overhead crane, and then fed into the grate system by a hydraulic ramp or another conveying system. The grate moves the waste through the various zones of the combustion chamber in a tumbling motion.

The filling hopper is used as a continuous waste supplier. It is filled in batches by the overhead crane. As the filling hopper surface is exposed to great stress, materials with high friction resistance are selected (e.g. boilerplates or wear-resistant cast iron). The material must survive occasional hopper fires unscathed.

The waste hopper may sometimes be fed by a conveyor. In that case, the overhead crane discharges waste into an intermediate hopper that feeds the conveyor. [74, TWGComments, 2004]

If the delivered waste has not been pretreated, it is generally very heterogeneous in both size and nature. The feed hopper is therefore dimensioned in such a way that bulky materials fall through and bridge formations and blockages are avoided. These blockages must be avoided as they can result in uneven feeding to the furnace and uncontrolled air ingress to the furnace.

Feeder chute walls can be protected from heat using:

- water-cooled double shell construction
- membrane wall construction
- water-cooled stop valves
- fireproof brick lining.

If the feed chute is empty, stop valve equipment (e.g. door seals) can be used to avoid flashbacks and for the prevention of uncontrolled air infiltration into the furnaces. A uniform amount of waste in the filling chute is recommended for uniform furnace management.

The junction between the lower end of the filling chute and the furnace consists of a dosing mechanism. The dosing mechanism may be driven either mechanically or hydraulically. Its feeding rate is generally adjustable. Different construction methods have been developed for the various types of feeder systems, such as:

- chain grates/plate bands
- feeder grates
- variable taper feed chutes
- RAM feeders
- hydraulic ramp
- feed screws.

[74, TWGComments, 2004]

### 2.3.1.2 Incineration grate

The incineration grate accomplishes the following functions:

- transport of materials to be incinerated through the furnace
- stoking and loosening of the materials to be incinerated
- positioning of the main incineration zone in the incineration chamber, possibly in combination with furnace performance control measures.



A target of the incineration grate is a good distribution of the incineration air into the furnace, according to combustion requirements. A primary air blower forces incineration air through small grate layer openings into the fuel layer. More air is generally added above the waste bed to complete combustion.

It is common for some fine material (sometimes called *riddlings or siftings*) to fall through the grate. This material is recovered in the bottom ash remover. Sometimes it is recovered separately and may be recycled to the grate for repeated incineration or removed directly for disposal. When the sifting is recirculated in the hopper, care should be taken not to ignite the waste in the hopper. [74, TWGComments, 2004]

Normally, the residence time of the wastes on the grates is not more than 60 minutes. [74, TWGComments, 2004]

In general, one can differentiate between continuous (roller and chain grates) and discontinuous feeder principles (push grates). Figure 2.4 shows some types of grates:

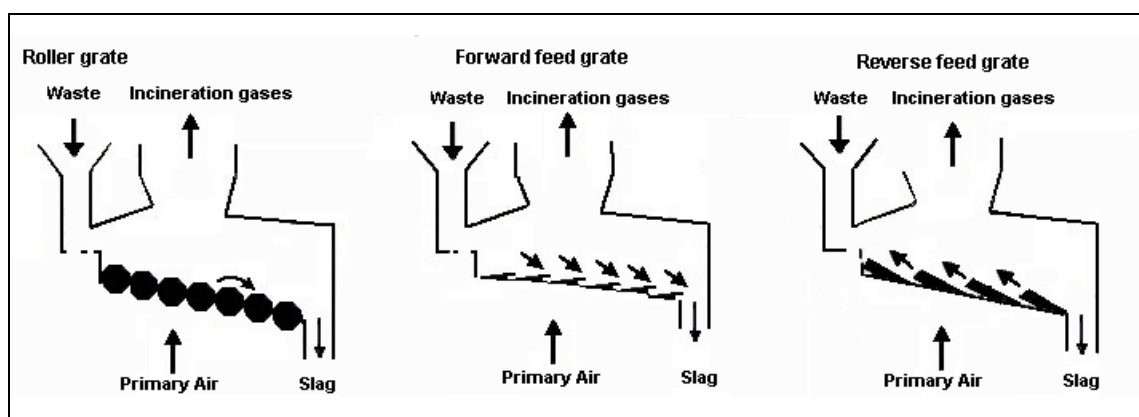

**Figure 2.4: Different grate types**  
Source [1, UBA, 2001]

Different grate systems can be distinguished by the way the waste is conveyed through the different zones in the combustion chamber. Each has to fulfil requirements regarding primary air feeding, conveying velocity and raking, as well as mixing of the waste. Other features may include additional controls, or a more robust construction to withstand the severe conditions in the combustion chamber.

#### 2.3.1.2.1 Rocking grates

[4, IAWG, 1997] The grate sections are placed across the width of the furnace. Alternate rows are mechanically pivoted or rocked to produce an upward and forward motion, advancing and agitating the waste.

#### 2.3.1.2.2 Reciprocating grates

[4, IAWG, 1997] Many modern facilities (for municipal wastes) use reciprocating grates. The quality of burnout achieved is generally good.

This design consists of sections that span the width of the furnace but are stacked above each other. Alternate grate sections slide back and forth, while the adjacent sections remain fixed. Waste tumbles off the fixed portion and is agitated and mixed as it moves along the grate. Numerous variations of this type of grate exist, some with alternating fixed and moving sections, others with combinations of several moving sections to each fixed section. In the latter case, the sections can either move together or at different times in the cycle.

There are essentially two main reciprocating grate variations:

1. Reverse reciprocating grate:

The grate bars oscillate back and forth in the reverse direction to the flow of the waste. The grate is sloped from the feed end to the ash discharge end and is comprised of fixed and moving grate steps.

2. Push forward grate:

The grate bars form a series of many steps that oscillate horizontally and push the waste in the direction of the ash discharge.

### **2.3.1.2.3 Travelling grates**

This consists of a continuous metal belt conveyor or interlocking linkages that move along the length of the furnace. The reduced potential to agitate the waste (it is only mixed when it transfers from one belt to another) means that it is seldom used in modern facilities. [IAWG, 1997 #4]

### **2.3.1.2.4 Roller grates**

This consists of a perforated roller that traverses the width of the grate area. Several rollers are installed in series and a stirring action occurs at the transition when the material tumbles off the rollers. [4, IAWG, 1997]

### **2.3.1.2.5 Cooled grates**

Most grates are cooled, most often with air. In some cases a liquid cooling medium (usually water) is passed through the inside of the grate. The flow of the cooling medium is from colder zones to progressively hotter ones in order to maximise the heat transfer. The heat absorbed by the cooling medium may be transferred for use in the process or for external supply.

Water cooling is most often applied where the calorific value of the waste is higher e.g. >12 - 15 MJ/kg for MSW. The design of the water cooled system is slightly more complex than air cooled systems.

The addition of water cooling may allow grate metal temperature and local combustion temperature to be controlled with greater independence from the primary air supply (normally between the grate bars). This may then allow temperature and air (oxygen) supply to be optimised to suit specific on-grate combustion requirements and thereby improve combustion performance. Greater control of grate temperature can allow incineration of higher calorific value wastes without the normally increased operational and maintenance problems.

### **2.3.1.3 Bottom ash discharger**

The bottom ash discharger is used for cooling and removal of the solid residue that accumulates on the grate. It also serves as an air seal for the furnace and cools and humidifies the ash.

Water-filled pressure pistons and drag constructions are commonly used to extract the bottom ash. Other bottom ash discharges, such as belt conveyors are also commonly used. Grate ashes, as well as any bulky objects are thus conveyed.

The water used for cooling is separated from the grate ash at the exit, and may be re-circulated to the ash discharger. A water top-up feed is usually required to maintain an adequate water level in the discharger. The top-up water replaces losses with the removed ash and evaporation losses. In addition a water drain may be needed to prevent the build up of salts – such bleed systems can help to reduce the salt content of the residues if the flowrates are adjusted specifically for this purpose. The bottom ash removal shaft is usually fireproof and is constructed in such a way that bottom ash caking is avoided.



**Figure 2.5: Example of a type of ash remover used at a grate incinerator**  
Source [1, UBA, 2001]

#### 2.3.1.4 Incineration chamber and boiler

Combustion takes place above the grate in the incineration chamber (see Figure 2.6). As a whole, the incineration chamber typically consists of a grate situated at the bottom, cooled and non-cooled walls on the furnace sides, and a ceiling or boiler surface heater at the top. As municipal waste generally has a high volatile content, the volatile gases are driven off and only a small part of the actual incineration takes place on or near the grate.

The following requirements influence the design of the incineration chamber:

- form and size of the incineration grate - the size of the grate determines the size of the cross-section of the incineration chamber
- vortexing and homogeneity of flue-gas flow - complete mixing of the flue-gases is essential for good flue-gas incineration
- sufficient residence time for the flue-gases in the hot furnace - sufficient reaction time at high temperatures must be assured for complete incineration
- partial cooling of flue-gases - in order to avoid fusion of hot fly ash at the boiler, the flue-gas temperature must not exceed an upper limit at the incineration chamber exit.

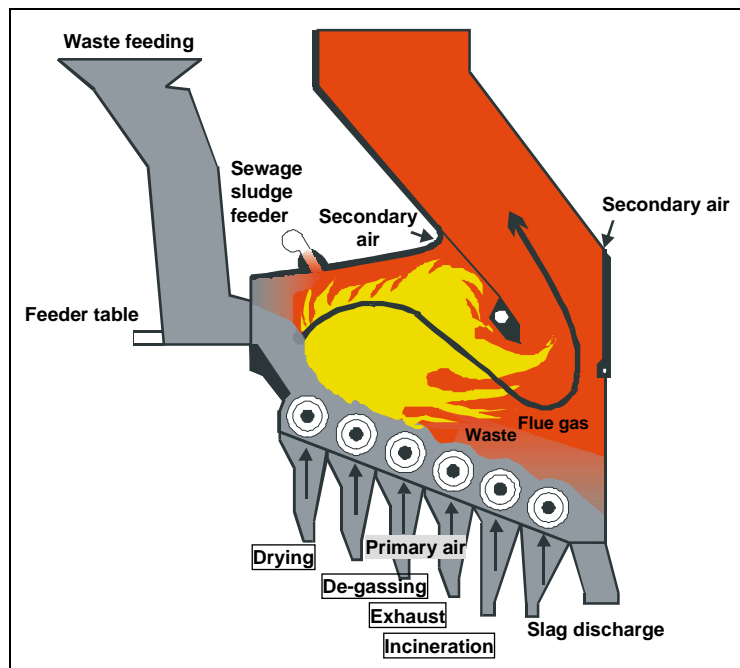

**Figure 2.6: Example of an incineration chamber**  
Source [1, UBA, 2001]

The detailed design of a combustion chamber is usually linked to the grate type. Its precise design demands certain compromises as the process requirements change with the fuel characteristics. Each supplier has their own combination of grate and combustion chamber, the precise design of which is based on the individual performance of their system and their specific experiences. European operators of MSW have found no fundamental advantage or disadvantage for the different designs of the combustion chamber.

In general, three different designs can be distinguished. The nomenclature comes from the flow direction of the flue-gases in relation to the waste flow: unidirectional current; countercurrent and medium current (see Figure 2.7).

Unidirectional current, co-current, or parallel flow furnace:

In a co-current combustion arrangement, primary combustion air and waste are guided in a co-current flow through the combustion chamber. Accordingly, the flue-gas outlet is located at the end of the grate. Only a comparatively low amount of energy is exchanged between the combustion gases and the waste on the grate.

The advantage of unidirectional current concepts is that the flue-gas has the longest residence time in the ignition area and that it must pass through the maximum temperature. To facilitate ignition, the primary air must be pre-warmed with very low heat values.

Counter-flow or countercurrent furnace:

In this case, primary combustion air and waste are guided in a countercurrent flow arrangement through the combustion chamber and the flue-gas outlet is located at the front end of the grate. The hot flue-gases facilitate drying and ignition of the waste

Special attention must be paid to avoid the passage of unburned gas streams. As a rule, counter-flow current concepts require higher secondary or upper air additions.

Medium-current or centre-flow furnace:

The composition of municipal solid waste varies considerably and the medium current concept is a compromise for a wide feed value spectrum. A good mixture of all partial flue-gas currents must be considered through mixture-promoting contours and/or secondary air injections. In this case, the flue-gas outlet is located in the middle of the grate.

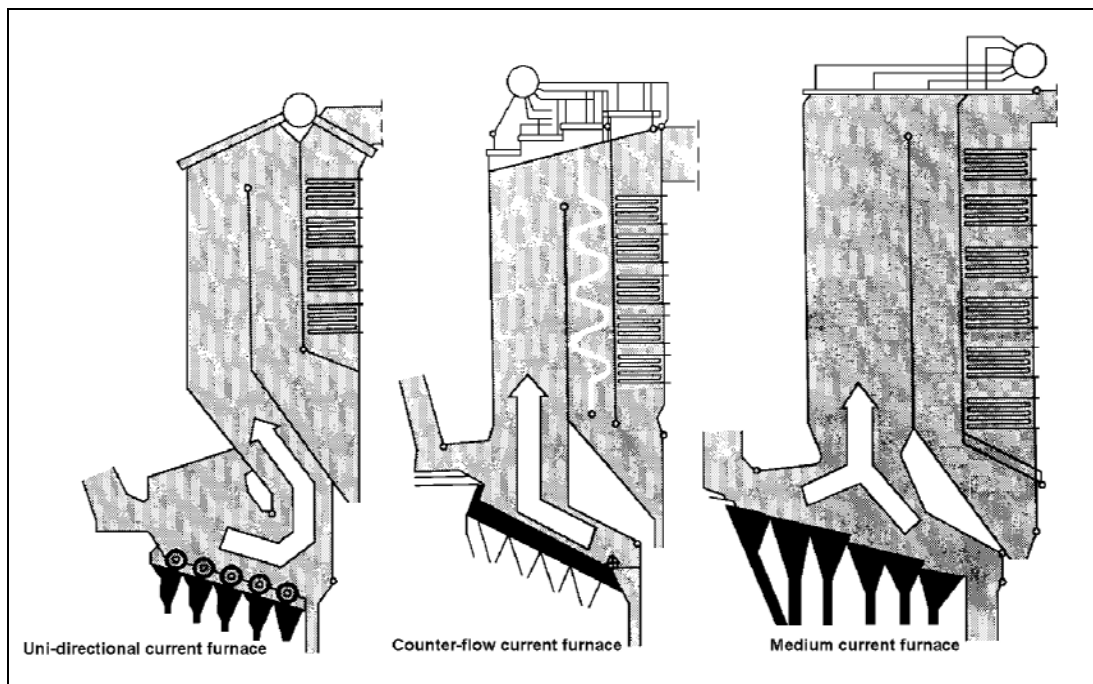

**Figure 2.7: Various furnace designs with differing direction of the flue-gas and waste flow [1, UBA, 2001]**

### 2.3.1.5 Incineration air feeding

The incineration air fulfils the following objectives:

- provision of oxidant
- cooling
- avoidance of slag formation in the furnace
- mixing of flue-gas.

Air is added at various places in the combustion chamber. It is usually described as primary and secondary, although tertiary air, and re-circulated flue-gases are also used.

The primary air is generally taken from the waste bunker. This lowers the air pressure in the bunker hall and eliminates most odour emissions from the bunker area. Primary air is blown by fans into the areas below the grate, where its distribution can be closely controlled using multiple wind boxes, and distribution valves.

The air can be preheated if the value of the waste degenerates to such a degree that it becomes necessary to pre-dry the waste. The primary air will be forced through the grate layer into the fuel bed. It cools the grate bar and carries oxygen into the incineration bed.

Secondary air is blown into the incineration chamber at high speeds via, for example, injection lances or from internal structures. This is carried out to secure complete incineration and is responsible for the intensive mixing of flue-gases, and prevention of the free passage of unburned gas streams.

### 2.3.1.6 Auxiliary burner

At start-up, auxiliary burners are commonly used to heat up the furnace to a specified temperature through which the flue-gases can pass. This is the main use of auxiliary burners. These burners are usually switched on automatically if the temperature falls below the specified value during operation. During shut down, the burners are often only used if there is waste in the furnace. [74, TWGComments, 2004]

### 2.3.1.7 Incineration temperature, residence time, minimum oxygen content

To achieve good burn out of the combustion gases, a minimum gas phase combustion temperature of 850 °C (1100 °C for some hazardous wastes) and a minimum residence time of the flue-gases, above this temperature, of two seconds after the last incineration air supply have been established in legislation (Directive 2000/76/EC and earlier legislation). Derogations from these conditions are allowed in legislation if they provide for a similar level of overall environmental performance. [74, TWGComments, 2004]

A minimum oxygen content of 6 % was required by earlier legislation but removed from the most recent EC Directive on incineration.

Operational experiences have in some cases shown that lower temperatures, shorter residence times and lower oxygen levels can, in some situations, still result in good combustion and may result in overall improved environmental performance. However, low oxygen content may lead to significant corrosion risk and therefore require specific material protection. [74, TWGComments, 2004]

The carbon monoxide content of the flue-gas is a key indicator of the quality of combustion.

### 2.3.1.8 Sewage sludge incineration in MSWI plants

Sewage sludge is sometimes incinerated with other wastes in grate municipal waste incineration plants (see Section 2.3.3, for information regarding the use of fluid beds and other technologies)

Where added to MSWI it is often the feeding techniques that represent a significant proportion of the additional investment costs.

The following three supply technologies are used:

- dried sewage sludge (~90 % d.s) is blown as dust into the furnace
- drained sewage sludge (~20 - 30 % d.s) is supplied separately through sprinklers into the incineration chamber and distributed on a grate. The sludge is integrated into the bed material by overturning the waste on the grates. Operational experiences show up to 20 mass-% sludge (at 25 % d.s.). Other experiences have shown that if the sludge ratio is too high (e.g.>10 %.), high fly ash content or unburnt material in bottom ash may occur.
- drained, dried or semi-dried (~50 - 60 % d.s.) sludge is mixed with the remaining waste or fed together into the incineration chamber. This can occur in the waste bunker through targeted doses by the crane operator, or controlled in a feeding hopper by pumping dewatered sludge into the hopper or by spreading systems into the bunker. [74, TWGComments, 2004]

### 2.3.1.9 Addition of clinical waste to a municipal waste incinerator

(Denmark 2002) Clinical waste is sometimes added into an existing municipal waste incinerator. In some cases the waste is loaded into the same hopper as the MSW.

Separate loading systems, with airlocks are also used. The airlock helps to prevent the entry of uncontrolled combustion air and the possibility of fugitive emissions at the loading area. Combustion takes place in the same furnace as the MSW.

The combined incineration of clinical waste with municipal solid waste can be also carried out without a separate loading. For example, automatic loading systems are implemented in order to put the clinical waste directly in the feed hopper with MSW.

National regulations sometimes limit the ratio of clinical waste that may be treated in combined incineration (e.g. in France <10 % thermal load)

Note that Article 6.7 of Waste Incineration Directive requires that infectious clinical waste should be placed straight in the furnace, without first being mixed with other categories of waste and without direct handling. [74, TWGComments, 2004]

Flue-gases from the different wastes are then treated in common FGT systems.

In Figure 2.8 below the order of the stages for a separate loading system are shown:

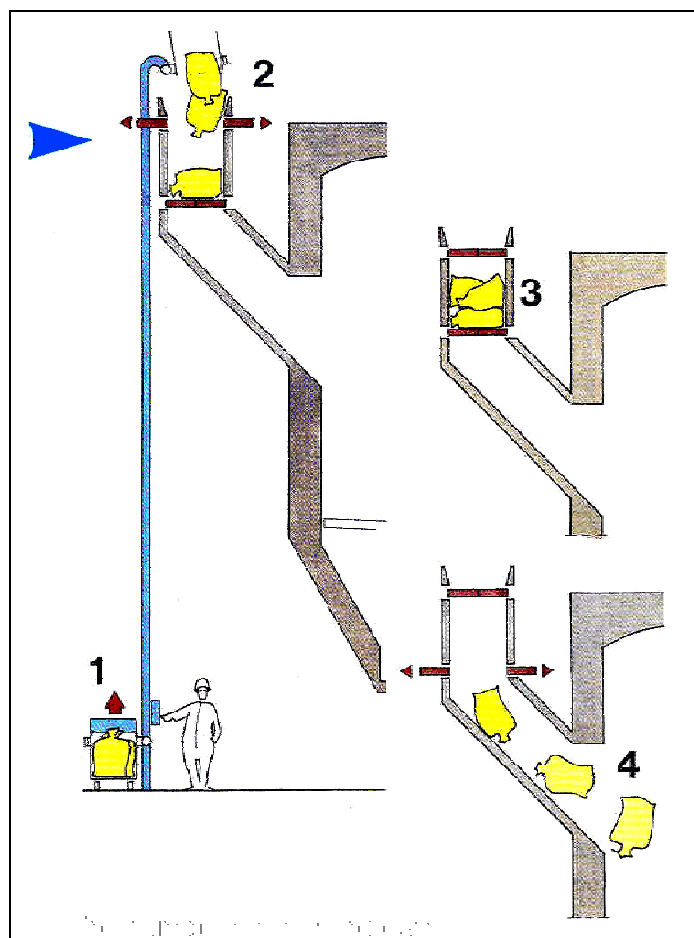

Figure 2.8: Examples of the stages of a clinical waste loading systems used at a municipal waste incinerator

Source [49, Denmark, 2002]

### 2.3.2 Rotary kilns

Rotary kilns are very robust and almost any waste, regardless of type and composition, can be incinerated. Rotary kilns are, in particular, very widely applied for the incineration of hazardous wastes. The technology is also commonly used for clinical wastes (most hazardous clinical waste is incinerated in high temperature rotary kiln incinerators [64, TWGComments, 2003], but less so for municipal wastes.

Operating temperatures of rotary kilns used for wastes range from around 500 °C (as a gasifier) to 1450 °C (as a high temperature ash melting kiln). Higher temperatures are sometimes encountered, but usually in non-waste applications.

When used for conventional oxidative combustion, the temperature is generally above 850 °C. Temperatures in the range 900 - 1200 °C are typical when incinerating hazardous wastes.

Generally, and depending on the waste input, the higher the operating temperature, the greater the risk of fouling and thermal stress damage to the refractory kiln lining. Some kilns have a cooling jacket (using air or water) that helps to extend refractory life, and therefore the time between maintenance shut-downs.

A schematic drawing of a rotary kiln incineration system is shown below.

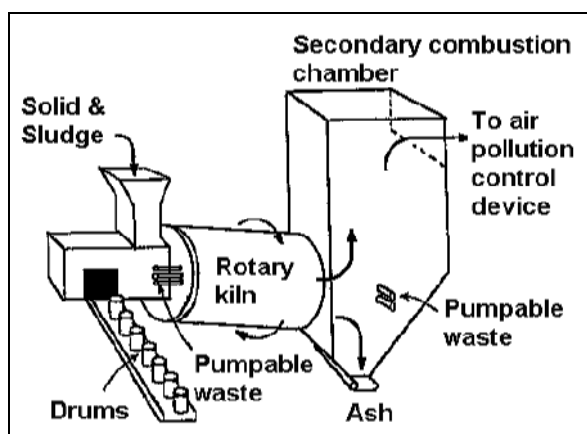

Figure 2.9: Schematic of a rotary kiln incineration system  
Source [EGTEI, 2002 #6]

The rotary kiln consists of a cylindrical vessel slightly inclined on its horizontal axis. The vessel is usually located on rollers, allowing the kiln to rotate or oscillate around its axis (reciprocating motion). The waste is conveyed through the kiln by gravity as it rotates. Direct injection is used particularly for liquid, gaseous or pasty (pumpable) wastes – especially where they have safety risks and require particular care to reduce operator exposure.

The residence time of the solid material in the kiln is determined by the horizontal angle of the vessel and the rotation speed: a residence time of between 30 to 90 minutes is normally sufficient to achieve good waste burnout.

Solid waste, liquid waste, gaseous waste, and sludges can be incinerated in rotary kilns. Solid materials are usually fed through a non-rotating hopper; liquid waste may be injected into the kiln through burner nozzles; pumpable waste and sludges may be injected into the kiln via a water cooled tube.

In order to increase the destruction of toxic compounds, a post-combustion chamber is usually added. Additional firing using liquid waste or additional fuel may be carried out to maintain the temperatures required to ensure the destruction of the waste being incinerated.



### 2.3.2.1 Kilns and post combustion chambers for hazardous waste incineration

The operational **kiln temperature** of installations for incineration usually varies from 850 °C up to 1300 °C. The temperature may be maintained by burning higher calorific (e.g. liquid) waste, waste oils, heating oil or gas. Higher-temperature kilns may be fitted with water-based kiln cooling systems, which are preferred for operation at higher temperatures. The operation at higher temperatures may result in molten (vitrified) bottom ash (slag); at lower temperatures the bottom ashes are sintered.

The temperatures in the **post combustion chamber (PCC)** typically vary between 900 - 1200 °C depending on the installation and the waste feed. Most installations have the ability to inject secondary air into the post combustion chamber. Due to the high temperatures and the secondary air introduction, the combustion of the exhaust gases is completed and organic compounds (e.g. PAHs, PCBs and dioxins) including low molecular weight hydrocarbons, are destroyed. In several countries exemptions from the 1100 °C rule are granted, on the basis of studies demonstrating that lowering the temperature in the PCC does not influence the quality of air emissions.

### 2.3.2.2 Drum kiln with post-combustion chamber for hazardous waste incineration

For the incineration of hazardous waste, a combination of drum-type kilns and post-combustion chambers has proven successful, as this combination can treat solid, pasty, liquid, and gaseous wastes uniformly (see Figure 2.10).

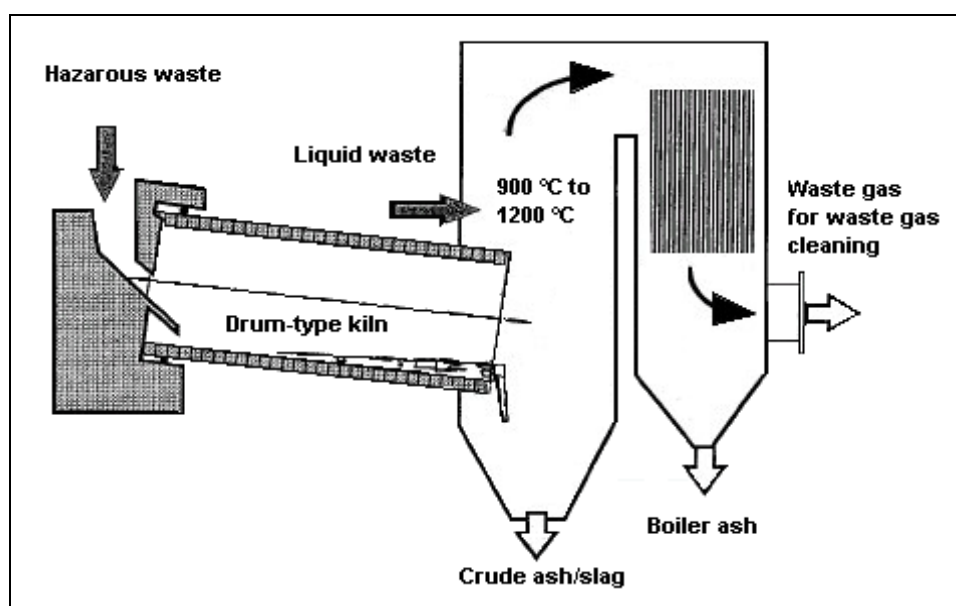

Figure 2.10: Drum-type kiln with post-combustion chamber  
Source [1, UBA, 2001]

Drum-type kilns between 10 and 15 metres in length, and with a length to diameter ratio usually in the range of 3 to 6, and with an inner diameter between one and five metres are usually deployed for hazardous waste incineration.

Some drum-type kilns have throughputs of up to 70000 tonnes/yr each. In correlation to the average heat value of the waste, where heat recovery is carried out steam generation increases correspondingly.

Drum-type kiln plants are highly flexible in terms of waste input characteristics. The following range is usual in the composition of the waste input menu:

- solid wastes: 10 – 70 %
- liquid wastes: 25 – 70 %
- pasty wastes: 5 – 30 %
- barrels: up to 15 %.

To protect the drum-type kilns from temperatures of up to 1200 °C, it is equipped with refractory bricks. Bricks with a high content of  $\text{Al}_2\text{O}_3$  and  $\text{SiO}_2$  are used. The decision regarding the selection of bricks appropriate for each application is a function of the waste composition. The bricks can be attacked by alkaline metal compounds (formation of low melting eutectic alloys), as well as by HF. (formation of  $\text{SiF}_4$ ). To protect refractory bricks from chemical attacks and from the mechanical impact of falling barrels, a hardened slag layer will usually be formed at the beginning of the operation with the help of good slag forming wastes or materials as mixtures of glass or sand and glass. Later on the kiln temperature is usually managed so as to keep this slag layer, based on the mineral matter of the wastes and perhaps some additives as e.g. sand. [74, TWGComments, 2004]

There have been tests with other surfacing systems but neither injected nor stamped refractory masses have proved successful. The surfacing of the drum-type kiln with special alloyed steels was only successful in some special applications. The durability of the fireproof surfacing remains dependent upon the waste input. Service life of between 4000 and 16000 hours is normal.

Cooling the drum-type kilns is a means of lengthening their service life. Several positive experiences have been noted at various plants.

Drum-type kilns are tilted towards the post combustion chamber. This, along with the slow rotation (approx. 3 – 40 rotations per hour) facilitates the transport of solid hazardous wastes that are fed from the front side, as well as the bottom ash produced during incineration, in the direction of the post combustion chamber. These are then removed together with the ash from the post combustion chamber via a wet bottom ash remover. The residence time for solid wastes generally amounts to more than 30 minutes.

The post combustion chamber, provides residence time for the incineration of the flue-gases produced during incineration, as well as for the incineration of directly injected liquid and gaseous wastes. Minimum residence times in excess of two seconds are the basic requirement of EC Directive 2000/76/EC. The size of the post-combustion chamber and gas flows predict the actual residence times achieved. Reducing residence times can increase risks of incomplete gas burnout.

Operational experiences have in some cases shown that lower temperatures, shorter residence times and lower oxygen levels can, in some situations, still result in good combustion and may result in lower overall emissions to air. [74, TWGComments, 2004]

A drum-type kiln incineration plant with an incineration capacity of 45000 tonnes/yr is shown in Figure 2.11. The plant is divided into three main areas:

- drum-type kiln with post combustion chamber
- waste heat boiler for steam generation
- multi-step flue-gas cleaning.

There is, in addition, the infrastructure for the storage, feed system, and disposal for the waste and waste waters (from wet gas scrubbing) produced during incineration.

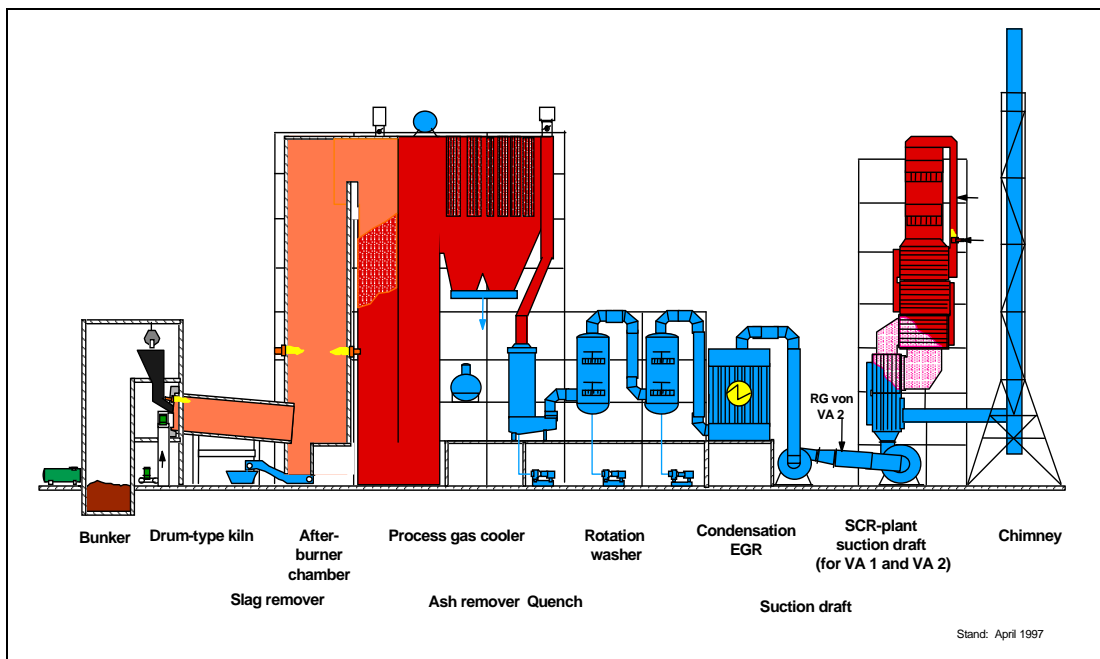

**Figure 2.11: Example of a drum-type kiln plant for hazardous waste incineration**  
Source [1, UBA, 2001]

### 2.3.3 Fluidised beds

Fluidised bed incinerators are widely applied to the incineration of finely divided wastes e.g. RDF and sewage sludge. It has been used for decades, mainly for the combustion of homogeneous fuels. Among these are coal, raw lignite, sewage sludge, and biomass (e.g. wood).

The fluidised bed incinerator is a lined combustion chamber in the form of a vertical cylinder. In the lower section, a bed of inert material, (e.g., sand or ash) on a grate or distribution plate is fluidised with air. The waste for incineration is continuously fed into the fluidised sand bed from the top or side [66, UllmansEncyclopaedia, 2001].

Preheated air is introduced into the combustion chamber via openings in the bed-plate, forming a fluidised bed with the sand contained in the combustion chamber. The waste is fed to the reactor via a pump, a star feeder or a screw-tube conveyor.

In the fluidised bed, drying, volatilisation, ignition, and combustion take place. The temperature in the free space above the bed (the freeboard) is generally between 850 and 950 °C. Above the fluidised bed material, the free board is designed to allow retention of the gases in a combustion zone. In the bed itself the temperature of is lower, and may be around 650 °C or higher.

Because of the well-mixed nature of the reactor, fluidised bed incineration systems generally have a uniform distribution of temperatures and oxygen, which results in stable operation. For heterogeneous wastes, fluidised bed combustion requires a preparatory process step for the waste so that it conforms with size specifications. For some waste this may be achieved by a combination of selective collection of wastes and/or pretreatment e.g. shredding. Some types of fluidised beds (e.g. the rotating fluidised bed) can receive larger particle size wastes than others. Where this is the case the waste may only require only a rough size reduction. [64, TWGComments, 2003] [74, TWGComments, 2004]

Pretreatment usually consists of sorting out and crushing larger inert particles, and shredding. Removal of ferrous and non-ferrous materials may also be required. The particle size of the waste must be small, often with a maximum diameter of 50 mm. However, it is reported that average acceptable diameters for rotating fluidised beds are 200 - 300 mm. [74, TWGComments, 2004]

The schematic diagram below shows an installation that pretreats mixed MSW for incineration in a fluidised bed incineration plant. Several pretreatment stages are shown including mechanical pulverisation and pneumatic separation, along with the final stages of incineration, FGT and residue storage:

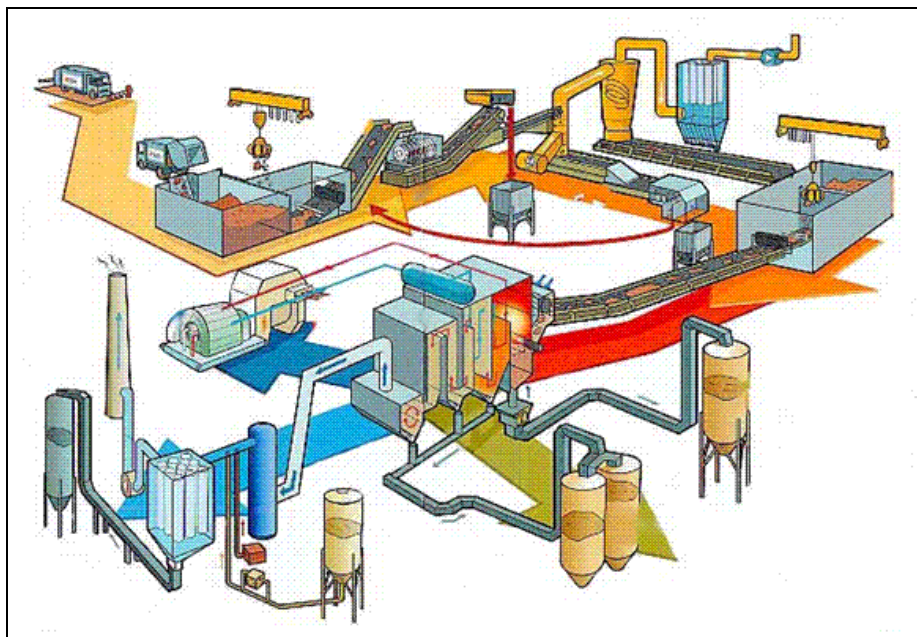

**Figure 2.12: Schematic diagram showing pretreatment of MSW prior to fluidised bed combustion**

During incineration the fluidised bed contains the unburned waste and the ash produced. The ash surplus is usually removed at the bottom of the furnace. [1, UBA, 2001, 33, Finland, 2002]

The heat produced by the combustion can be recovered by devices either integrated inside the fluidised bed or at the exit of the combustion gases or a mixture of layouts.

The relatively high cost of pretreatment processes required for some wastes has restricted the economic use of these systems to larger scale projects. This has been overcome in some cases by the selective collection of some wastes, and the development of quality standards for waste derived fuels (WDF). Such quality systems have provided a means of producing a more suitable feedstock for this technology. The combination of a prepared quality controlled waste (instead of mixed untreated waste) and fluidised bed combustion can allow improvements in the control of the combustion process, and the potential for a simplified, and therefore reduced cost, flue-gas cleaning stage.

The following table shows the properties of various waste fractions that are treated in fluidised beds [33, Finland, 2002]:

		<b>Commercial waste</b>	<b>Pretreated construction waste</b>	<b>Sorted and pretreated household waste</b>
Lower heating value as received	MJ/kg MWh/t	16 – 20 4.4 – 5.6	14 – 15 3.8 – 4.2	13 – 16 3.6 – 4.4
Moisture	Wt %	10 – 20	15 – 25	25 – 35
Ash	Wt %	5 – 7	1 – 5	5 – 10
Sulphur	Wt %	<0.1	<0.1	0.1 – 0.2
Chlorine	Wt %	<0.1 – 0.2	<0.1	0.3 – 1.0
Storage properties	Wt %	Good	Good	Good as pellets

**Table 2.6: Properties of various RDF (Refuse Derived Fuel) fractions treated in fluidised beds. [33, Finland, 2002]**

The following fluidised bed furnace technologies can be differentiated according to the gas speeds and design of the nozzle plate:

- **stationary (or bubbling) fluidised bed** (atmospheric and pressurised): The inert material is mixed, but the resulting upwards movement of solids is not significant (see Figure 2.13)
- a version of bubbling fluidised bed is the **rotating fluidised bed**: Here, the fluidised bed is rotated in the incineration chamber. This results in longer residence time in the incineration chamber. Rotating fluidised bed incinerators have been used for mixed municipal waste for about ten years
- **circulating fluidised bed**: The higher gas speeds in the combustion chamber are responsible for partial removal of the fuel and bed material, which is fed back into the incineration chamber by a re-circulation duct (see diagram Figure 2.14).

In order to start-up the incineration process, the fluidised bed must be heated to at least the minimum ignition temperature of the added waste (or higher where required by legislation). This may be accomplished by preheating the air with oil or gas burners, which remain operative until incineration can occur independently. The waste falls into the fluidised bed, where it is crushed through abrasion and incineration. Usually, the major part of the ash is transported with the flue-gas flow and requires separation in FGT equipment, although the actual proportion of bottom ash (removed from the base of the bed) and the fly ash depends on the fluidised bed technology and waste itself. [1, UBA, 2001].

Fouling problems, common in waste incineration boilers can be managed by controlling waste quality (mostly keeping Cl, K, Na and Al low) and by boiler and furnace design. Some boiler and furnace designs can be used in fluidised beds (but not in mixed waste grate boilers) because of the more stable temperatures and the presence of the bed material.

### 2.3.3.1 Stationary (or bubbling) fluidised bed incineration

This type of fluidised bed is commonly used for sewage sludge, as well as for other industrial sludges e.g. petrochemical and chemical industry sludges.

The stationary, or bubbling fluidised bed (see Figure 2.13), consists of a cylindrical or rectangular lined incineration chamber, a nozzle bed, and a start-up burner located below.

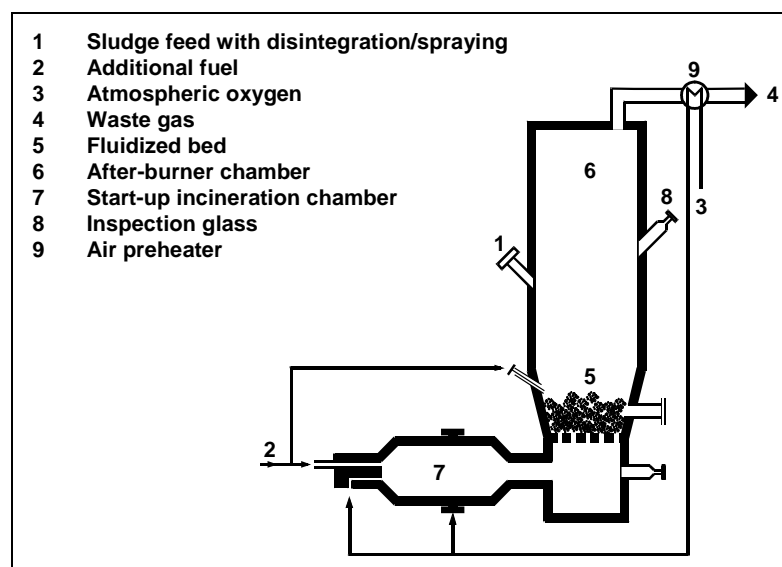

Figure 2.13: Main components of a stationary/bubbling fluidised bed  
 Source [1, UBA, 2001]

Preheated airflows up through a distribution plate and fluidises the bed material. According to the application, various bed materials (silica sand, basalt, mullite, etc.) and bed material particle sizes (approx 0.5 – 3 mm) can be used.

[2, infomil, 2002], [64, TWGComments, 2003]

The waste can be loaded via the head, on the sides with belt-charging machines, or directly injected into the fluidised bed. In the bed, the waste is crushed and mixed with hot bed material, dried and partially incinerated. The remaining fractions (volatile and fine particles) are incinerated above the fluidised bed in the freeboard. The remaining ash is removed with the flue-gas at the head of the furnace.

Drainage and drying pretreatment stages can be used so that the waste burns without the need for additional fuels. Recovered heat from the incineration process may be used to provide the energy for waste drying.

At start-up, or when sludge quality is low, (e.g. with old sludge or a high share of secondary sludge) additional fuel (oil, gas, and/or waste fuel) can be used to reach the prescribed furnace temperature (typically 850 °C). Water can be injected into the furnace to control the temperature.

The furnace is usually preheated to its operating temperature before waste feeding starts. For this purpose a start-up incineration chamber (see Figure 2.13) may be located below the nozzle bed. This has an advantage over an overhead burner, as the heat is introduced directly into the fluidised bed. Additional preheating may be provided by fuel lances that protrude over the nozzle bed into the sand bed. The sewage sludge is supplied when the furnace temperature reaches the operating temperature, e.g. 850 °C.

The size of the furnace is largely determined by the required evaporation (furnace cross-section), the heat turnover in the furnace (furnace volume) and the required amount of air.

Example operational parameters for a fluidised bed sewage sludge incinerator are shown in Table 2.7:

Parameter	Units	Value
Steam load	kg/m <sup>2</sup> h	300 – 600
Feed air amount	Nm <sup>3</sup> /m <sup>2</sup> h	1000 – 1600
Heat turnover	GJ/m <sup>3</sup> h	3 – 5
Final incineration temperature	°C	850 – 950
Residence time, open space and afterburner zone	sec.	min. 2
Preheating of atmospheric oxygen	°C	400 – 600

**Table 2.7: Main operational criteria for stationary fluidised beds**

Source [1, UBA, 2001]

The preheating of air can be eliminated completely with higher caloric fuels (e.g. dried sewage sludge, wood, animal by-products). The heat can be removed via membrane walls and/or immersed heat exchange systems.

Some processes incorporate drying as a first step. Steam for the drying may be produced by a boiler and then used as the heating medium with no direct contact between the steam and the sludge. Sludge vapours can be extracted from the dryer and condensed. The condensed water typically has a high COD (approx. 2000 mg/l) and N-content (approx. 600 - 2000 mg/l) and may contain other pollutants (e.g. heavy metals) from the sewage sludge, and therefore will often require treatment before final discharge. The remaining non-condensates may be incinerated. After incineration, the flue-gases can be cooled in a heat exchanger in order to preheat the incineration air to temperatures of approximately 300°C and in some cases over 500°C. The remaining heat in the steam boiler can be recovered and used for the production of saturated steam (pressure level approx. 10 bar), which in turn can be used for the partial pre-drying of sludge. [64, TWGComments, 2003]

### 2.3.3.2 Circulating fluidised bed (CFB) for sewage sludge

The circulating fluidised bed (CFB see Figure 2.14 below) is especially appropriate for the incineration of dried sewage sludge with a high heat value. It works with fine bed material and at high gas speeds that remove the greater part of the solid material particles from the fluidised bed chamber with the flue-gas. The particles are then separated in a downstream cyclone and returned to the incineration chamber.

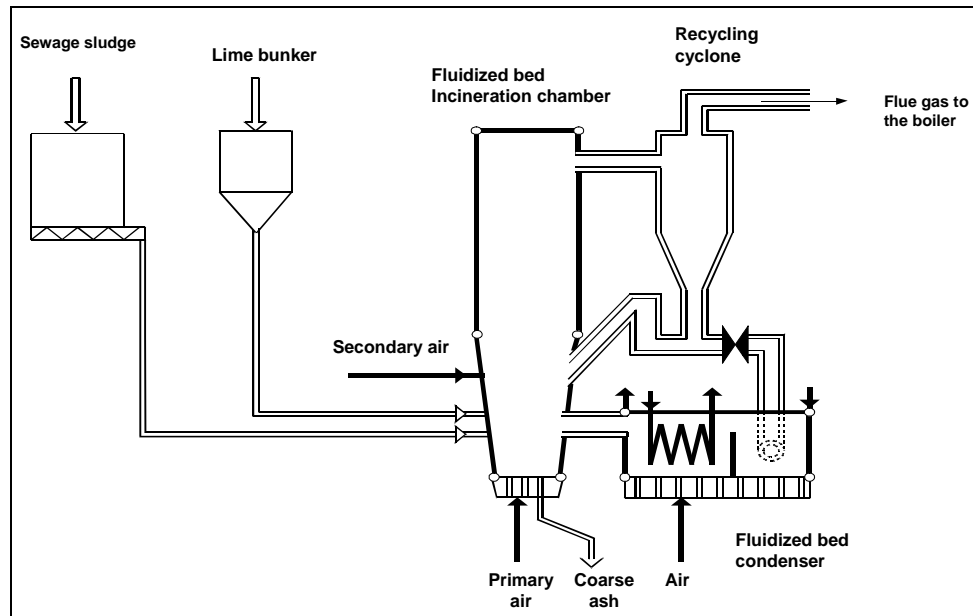

**Figure 2.14: Main components of a circulating fluidised bed**

Source [1, UBA, 2001]

The advantage of this process is that high heat turnovers and more uniform temperature along the height can be reached with low reaction volume. Plant size is generally larger than BFB and a wider range of waste inputs can be treated. The waste is injected at the side into the incineration chamber and is incinerated at 850 - 950 °C. The surplus heat is removed through membrane walls and via heat exchangers. The fluid bed condenser is placed between recycling cyclones and the CFB, and cools the returned ash. Using this method, the heat removal can be controlled.

### 2.3.3.3 Spreader-stoker furnace

[64, TWGComments, 2003]

This system may be considered as an intermediate system between grate and fluidised bed incineration.

The waste (e.g. RDF, sludge etc) is blown into the furnace pneumatically at a height of several metres. Fine particles participate directly in the incineration process, while the larger particles fall on the travelling grate, which is moving in the opposite direction to the waste injection. As the largest particles are spread over the greatest distance, they spend the longest time on the grate in order to complete the incineration process. Secondary air is injected to ensure that the flue-gases are adequately mixed in the incineration zone.

Compared to grate incineration the grate is of less complicated construction due to the relatively smaller thermal and mechanical load. When compared to fluidised bed systems the uniformity of particle size is less important and that there is a lower risk of clogging.

### 2.3.3.4 Rotating fluidised bed

[74, TWGComments, 2004]

This system is a development of bubbling bed for waste incineration. Inclined nozzle plates, wide bed ash extraction chutes and upsized feeding and extraction screws are specific features to ensure reliable handling of solid waste. Temperature control within the refractory lined combustion chamber (bed and freeboard) is by flue-gas recirculation. This allows a wide range of calorific value of fuels, e.g. co-combustion of sludges and pretreated wastes.

## 2.3.4 Pyrolysis and gasification systems

### 2.3.4.1 Introduction to gasification and pyrolysis

[9, VDI, 2002] Alternative technologies for thermal waste treatment have been developed since the 1970s. In general these have been applied to selected waste streams and on a smaller scale than incineration.

These technologies attempt to separate the components of the reactions that occur in conventional waste incineration plants by controlling process temperatures and pressures in specially designed reactors (see Table 2.1).

As well as specifically developed pyrolysis/gasification technologies, standard incineration technologies (i.e. grates, fluidised beds, rotary kilns, etc) may be adapted to be *operated* under pyrolytic or gasifying conditions i.e. with reduced oxygen levels (*sub-stoichiometric*), or at lower temperatures. Often pyrolysis and gasification systems are coupled with downstream combustion of the *syngas* generated (see Section 2.3.4.4 on combination processes).

As well as the normal targets of waste incineration (i.e. effective treatment of the waste), the additional aims of gasification and pyrolysis processes are to:

- convert certain fractions of the waste into process gas (called syngas)
- reduce gas cleaning requirements by reducing flue-gas volumes.

Both pyrolysis and gasification differ from incineration in that they may be used for recovering the chemical value from the waste (rather than its energetic value). The chemical products derived may in some cases then be used as feedstock for other processes. However, when applied to wastes, it is more common for the pyrolysis, gasification and a combustion based process to be combined, often on the same site as part of an integrated process. When this is the case the installation is, in total, generally recovering the energy value rather than the chemical value of the waste, as would a normal incinerator

In some cases the solid residues arising from such processes contain pollutants that would, in an incineration system, be transferred to the gas phase, and then with efficient flue-gas cleaning, be removed with the FGT residue. [64, TWGComments, 2003]

The following systems and concepts have been developed (with different levels of proven success on an industrial scale):

#### Pyrolysis - incineration systems for wastes:

- |          |   |
|----------|---|
| System 1 | Pyrolysis in a rotary kiln - coke and inorganic matter separation - incineration of pyrolysis gas                               |
| System 2 | Pyrolysis in a rotary kiln - separation of inert materials - combustion of the solid carbon rich fraction and the pyrolysis gas |



System 3	Pyrolysis in a rotary kiln - condensation of pyrolysis gas components - incineration of gas, oil and coke
System 4	Pyrolysis on a grate - directly connected incineration
System 5	Pyrolysis on a grate (with subsequent melting furnace for low metal content molten bottom ash production) - circulating fluidised bed (burnout of particles and gas).

#### **Gasification systems for wastes:**

System 1	Fixed bed gasifier - pretreatment drying required for lumpy material
System 2	Slag bath gasifier - as fixed bed but with molten bottom ash discharge
System 3	Entrained flow gasifier - for liquid, pasty and fine granular material that may be injected to the reactor by nozzles
System 4	Fluidised bed gasifier - circulating fluid bed gasifier for pretreated municipal waste, dehydrated sewage sludge and some hazardous wastes
System 5	Bubbling bed gasifier - similar to bubbling fluidised bed combustors, but operated at a lower temperature and as a gasifier.

#### **Pyrolysis - gasification systems for wastes:**

System 1	Conversion process - pyrolysis in a rotary kiln - withdrawal and treatment of solid phase - condensation of gas phase - subsequent entrained flow gasifier for pyrolysis gas, oil and coke
System 2	Combined gasification-pyrolysis and melting - partial pyrolysis in a push furnace with directly connected gasification in packed bed reactor with oxygen addition (e.g. Thermoselect).

Other systems have been developed for the purpose of pretreating wastes that are then combusted in other industrial plants. These co-incineration processes do not fall within the scope of this BREF.

#### **2.3.4.2 Gasification**

[64, TWGComments, 2003] Gasification is a partial combustion of organic substances to produce gases that can be used as feedstock (through some reforming processes), or as a fuel.

[1, UBA, 2001] There are several different gasification processes available or being developed which are in principle suited for the treatment of municipal wastes, certain hazardous wastes and dried sewage sludge.

It is important that the nature (size, consistency) of the wastes fed keeps within certain predefined limits. This often requires special pretreatment of municipal waste, for example.

The special features of the gasification process are:

- smaller gas volume compared to the flue-gas volume in incineration (by up to a factor of 10 by using pure oxygen)
- predominant formation of CO rather than CO<sub>2</sub>
- high operating pressures (in some processes)
- accumulation of solid residues as slag (in high temperature slagging gasifiers)
- small and compact aggregates (especially in pressure gasification)
- material and energetic utilisation of the synthesis gas
- smaller waste water flows from synthesis gas cleaning.

The following gasification reactors are used:

- fluidised bed gasifier (see Figure 2.17)
- current flow gasifier
- cyclone gasifier
- packed bed gasifier.

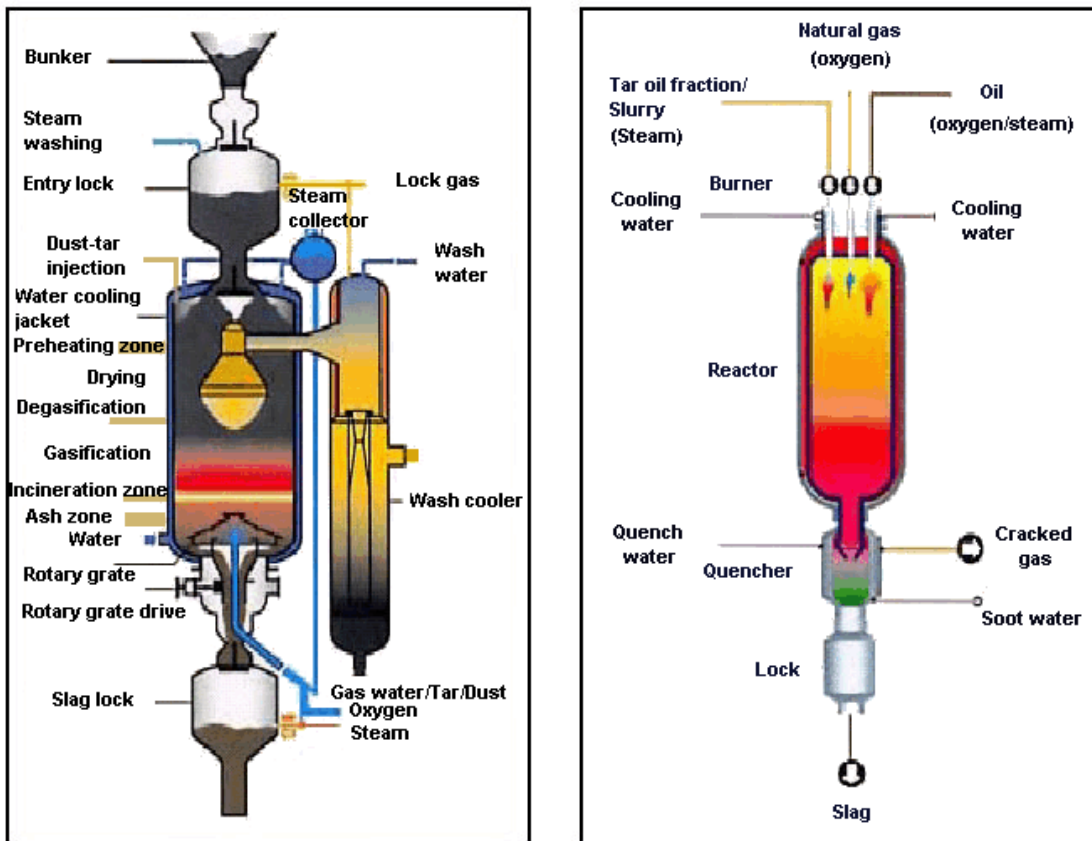

Figure 2.15: Representation of a packed bed and current flow gasifier  
Source [1, UBA, 2001]

For utilisation in entrained flow, fluidised bed or cyclone gasifiers, the feeding material must be finely granulated. Therefore pretreatment is necessary, especially for municipal wastes. Hazardous wastes, on the other hand, may be gasified directly if they are liquid, pasty or finely granulated.

### 2.3.4.2.1 Examples of gasification processes

[1, UBA, 2001]

In Germany, an entrained flow gasifier is at present in use for the gasification of fluid hazardous wastes at Sekundärrohstoffverwertungszentrum (SVZ; Centre for Secondary Raw Materials Utilisation) at Schwarze Pumpe.

The fluid wastes enter into the reactor via the burner system and are transformed into synthesis gas at temperatures of 1600 – 1800 °C. Since 1995, approx. 31000 tonnes of waste oil have been disposed of in this plant.

Lumpy charging material is required for the packed bed gasifier, but drying is sufficient as a pretreatment process. SVZ Schwarze Pumpe GmbH runs six packed bed gasifiers for gasification of coal waste mixtures. The feed rate proportion for waste is up to 85 %. In the reactors, each with a throughput of 8 - 14 tonnes per hour, mainly compacted waste plastics, dehydrated sewage sludge and contaminated soils are treated. The waste enters into the reactor through the entry lock and is transformed into synthesis gas at approx. 800 – 1300 °C and 25 bar with the help of steam and oxygen (the gasification agent).

A development from these packed bed gasifiers is the slag bath gasifier shown in Figure 2.16 below. One such plant is currently operating on a trial basis, receiving up to 70 % waste, at a throughput rate of 30 t/hr. The gasifier operates at a temperature of up to 1600 °C and the slag is discharged as a liquid.

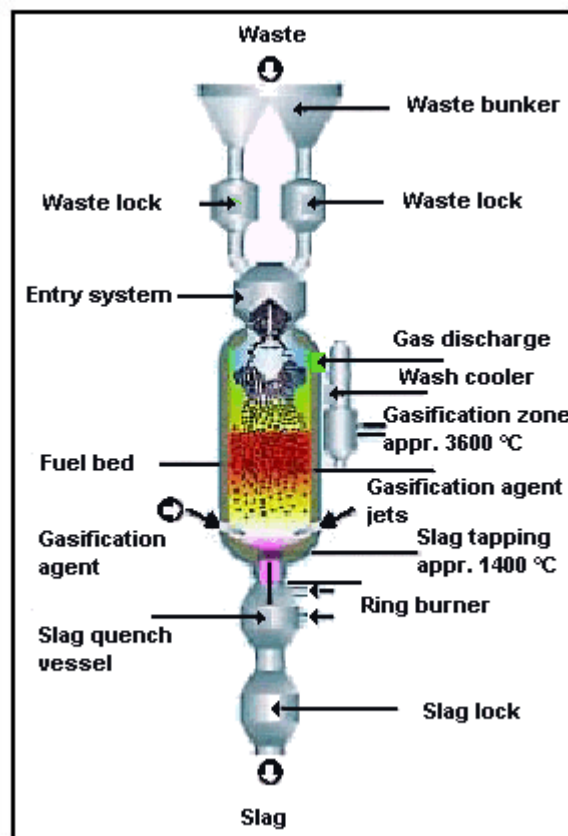

**Figure 2.16: Slag bath gasifier**  
Source [1, UBA, 2001]

A waste gasification process based on fluidised bed in combination with current flow gasification is used in Japan (see Figure 2.17 below).

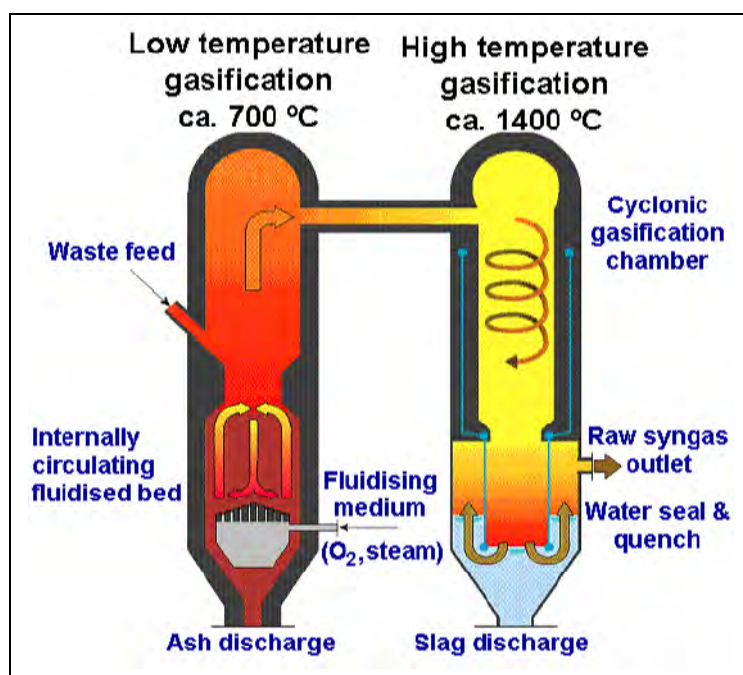

Figure 2.17: Fluidised bed gasifier with high temperature slugging furnace

Source [68, Ebara, 2003]

This process is designed to generate syngas from plastic packaging waste or other high calorific waste material. The main components of the process are a fluidised bed gasifier and a second stage high temperature gasifier. The fluidised bed enables rapid gasification of comparatively heterogeneous materials, which are pelletised for smooth feeding. Several per cent of non-combustible components, even metal pieces, are acceptable, as the ash is continuously discharged from the fluidised bed. The high temperature gasifier is designed as cyclone, to collect the fine ash particles on the wall. After vitrification the slag is discharged through a water seal. Both reactors are operated under elevated pressure, typically 8 bar.

A first plant of this technology was under commercial operation in year 2001 to treat plastic packaging waste. The capacity of this demonstration plant is 30 tonnes per day. An additional plant of 65 tonnes per day started operation in 2002. The syngas produced is fed to an adjacent ammonia production plant. Other similar plants are under construction. [68, Ebara, 2003]

Other variations on gasification processes have been tried and are being developed, for a variety of waste stream.

### 2.3.4.3 Pyrolysis

[1, UBA, 2001] Pyrolysis is the degassing of wastes in the absence of oxygen, during which pyrolysis gas and a solid coke are formed. The heat values of pyrolysis gas typically lies between 5 and 15 MJ/m<sup>3</sup> based on municipal waste and between 15 and 30 MJ/m<sup>3</sup> based on RDF. In a broader sense, “pyrolysis” is a generic term including a number of different technology combinations that constitute, in general, the following technological steps:

- **smouldering process:** Formation of gas from volatile waste particles at temperatures between 400 and 600 °C
- **pyrolysis:** Thermal decomposition of the organic molecules of the waste between 500 and 800 °C resulting in formation of gas and a solid fraction
- **gasification:** Conversion of the carbon share remaining in the pyrolysis coke at 800 to 1000 °C with the help of a gasification substance (e.g. air or steam) in a process gas (CO, H<sub>2</sub>)
- **incineration:** Depending on the technology combination, the gas and pyrolysis coke are combusted in a incineration chamber.

A pyrolysis plant for municipal waste treatment is operational in Germany, and another was due to start up at the end of 2003 in France. Other pyrolysis projects exist in Europe and elsewhere (notably in Japan) receiving certain specific types or fractions of waste, often after pretreatment.

Pyrolysis plants for waste treatment usually include the following basic process stages:

- 1 preparation and grinding: the grinder improves and standardises the quality of the waste presented for processing, and so promotes heat transfer
- 2 drying (depends on process): a separated drying step improves the LHV of the raw process gases and increase efficiency of gas-solid reactions within the rotary kiln
- 3 pyrolysis of wastes, where in addition to the pyrolysis gas a solid carbon-containing residue accumulates which also contains mineral and metallic portions
- 4 secondary treatment of pyrolysis gas and pyrolysis coke, through condensation of the gases for the extraction of energetically usable oil mixtures and/or incineration of gas and coke for the destruction of the organic ingredients and simultaneous utilisation of energy.

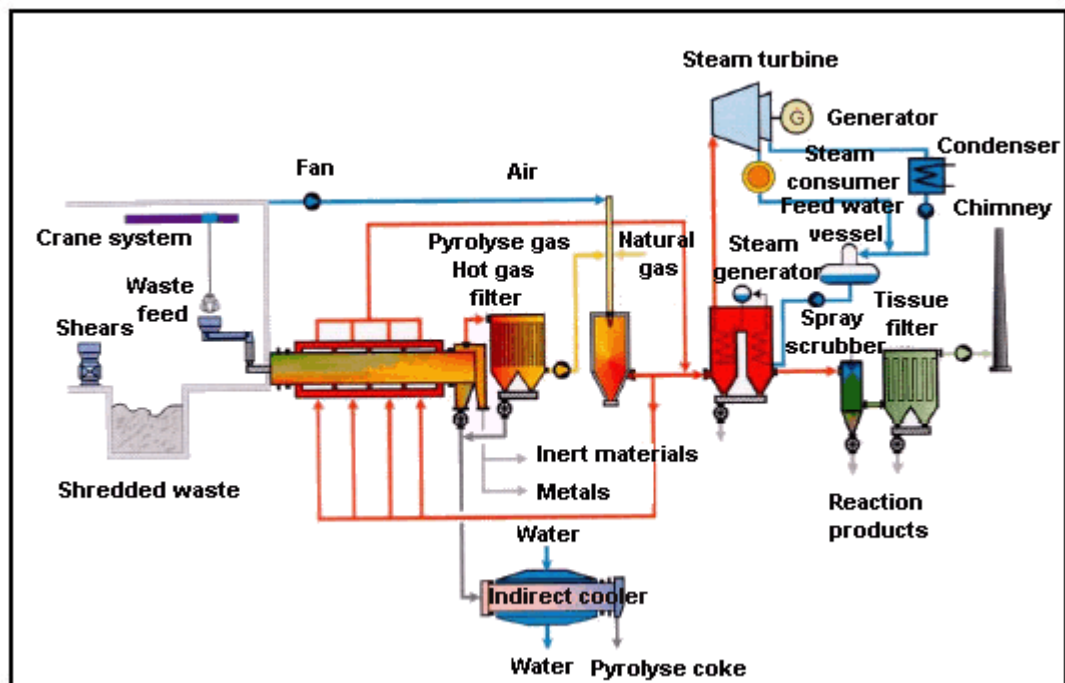

Figure 2.18: Structure of a pyrolysis plant for municipal waste treatment  
Source [1, UBA, 2001]

In general, the temperature of the pyrolysis stage is between 400 °C and 700 °C. At lower temperatures (approx. 250 °C) other reactions occur to some extent. This process is sometimes called conversion (e.g. conversion of sewage sludge).

In addition to the thermal treatment of some municipal wastes and sewage sludge, pyrolysis processes are also used for:

- decontamination of soil
- treatment of synthetic waste and used tyres
- treatment of cable tails as well as metal and plastic compound materials for substance recovery.

The potential advantages of pyrolysis processes may include:

- possibility of recovering the material value of the organic fraction e.g. as methanol
- possibility of increased electrical generation using gas engines or gas turbines for generation (in place of steam boilers)
- reduced flue-gas volumes after combustion, which may reduce the FGT capital costs to some degree
- the possibility of meeting specifications for external use of the produced char by washing (e.g. chlorine content).  
[64, TWGComments, 2003] [74, TWGComments, 2004]

### 2.3.4.3.1 Example of a pyrolysis process

[2, infomil, 2002]

In this example, solid industrial sludges and shredded paint waste/chemical packaging are treated.

The 'pyrolysis' unit is combined with a thermal treatment plant for polluted soil, in which synthesis gas (syngas) from the pyrolysis unit is used as fuel. The pyrolysis unit consists of two parallel reactors. Both are equipped with screws, which transport the feed material through the reactors. Feed materials include the filter cake and sediment of other on-site process waste water treatment facilities, as well as paint waste. The average organic material content varies between 25 – 85 %, and the average water content is approx. 25 %.

At start-up, the reactors are heated up with natural gas to approx. 500°C. Then feeding starts and the use of natural gas is stopped. The amount of air is kept below stoichiometric demand, resulting in a gasification process. Gasification temperature is approx. 900 – 1200°C. The capacity of the reactors is approx. 2 x 4 tonnes/hour.

The syngas is cooled down in a quench condenser. Remaining syngas (LHV approx. 7 MJ/Nm<sup>3</sup>) is used as fuel in another unit for the thermal treatment of polluted soil. Incineration and flue-gas treatment takes place according to Dutch emission standards. The condensed water of the quench is treated in a decanter for the separation of carbon. The water fraction is used for moisturising the reactor residues.

The residue of the reactor (temperature level approx. 500°C) passes a magnetic separation system for removal of the iron from the paint waste and the packaging fraction. The remaining fraction is cooled down and moisturised with condensed water, for disposal to landfill.

A general process scheme, including the main mass flows is given in the Figure below:

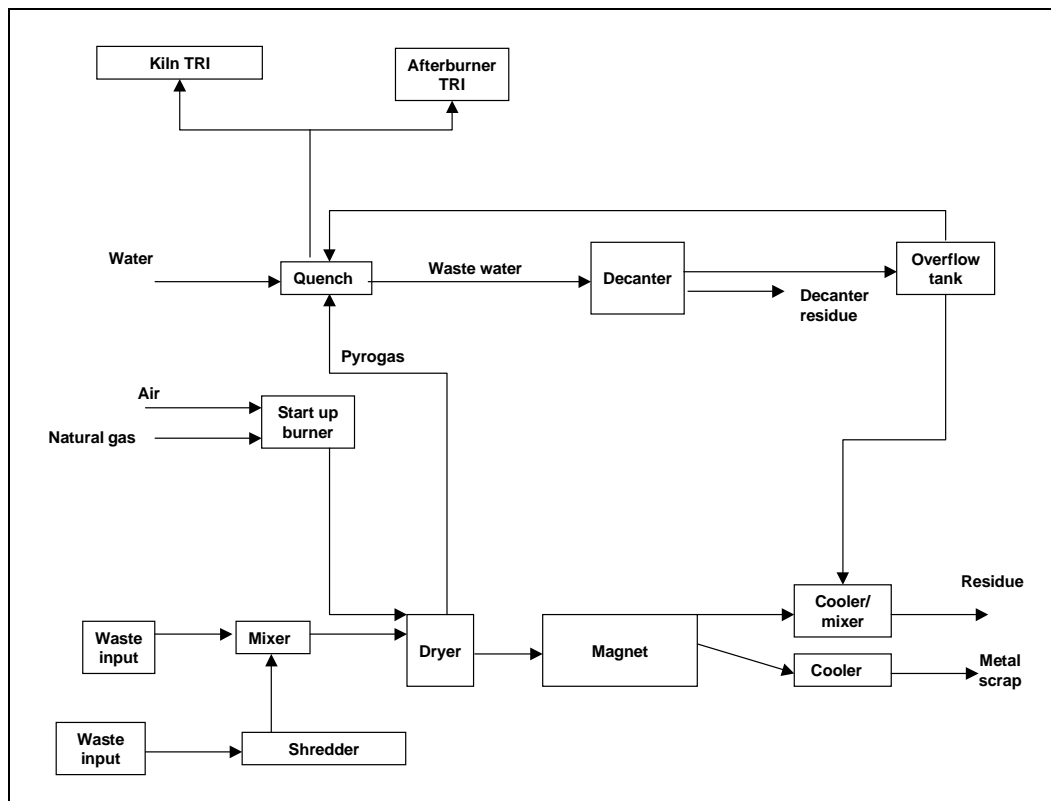

**Figure 2.19: Process scheme of ATM's 'pyrolysis'-unit**  
Source [2, infomil, 2002]

The main advantage of this pyrolysis unit is, that the surplus LHV, present in the treated filter cake, sediment and paint waste can be directly used in the thermal treatment unit for polluted soil. Energy efficiency, therefore, is at least comparable with waste incineration. Furthermore, the iron scrap fraction (15 %) is removed for recycling, while the volume of the treated waste is reduced by approx. 50 %. The remaining residues can partly be treated in ATM's own facilities. Overhead costs are reduced by the fact that it uses the incinerator and flue-gas treatment of a large polluted soil and waste treatment plant.

#### 2.3.4.3.2 Example of pyrolysis in combination with a power plant

[1, UBA, 2001]

In this example the pyrolysis unit is designed to be added to an existing power plant. It consists of two lines of drum-type kilns with a scheduled annual municipal waste throughput of 50000 tonnes each. The existing boiler unit will be supplied at full load with up to 10 % of the furnace thermal output from pyrolysed substitute fuels.

##### Specification of the ConTherm plant:

Heating in the absence of oxygen, to approx. 500 °C in an indirectly heated drum-type kiln plant, thermally decomposes the prepared waste fuels. The organic components are broken down into gaseous carbohydrates. Coke, pyrolysis gas, metals and inert materials are produced.

The metals in the fed waste, are now present in their metal form and can be withdrawn in a state of high purity. For this purpose there is a reutilisation plant at the end of drum-type kilns where the solid residue is separated into individual fractions. The residue is separated into a coarse fraction (metals, inerts) and a fine fraction. 99 % of the carbon is contained as coke in the fine fraction. After sifting, the coarse fraction is supplied to a wet ash remover, cooled and separated into ferrous and non-ferrous metals in a reprocessing plant.

The thermal energy is emitted through the furnace shell by radiation and to a lesser degree by convection to the waste within the drum-type kiln. The pyrolysis drum-type kiln is designed for the waste to be heated to approx. 450 to 550 °C and gasified within one hour.

The resulting pyrolysis gas consists of:

- vaporised water
- carbon monoxide
- hydrogen
- methane
- high-order carbohydrates.

A cyclone de-dusts the pyrolysis gas. The deposited dusts and carbon particles are added to the pyrolysis coke.

Integration of the ConTherm plant into the power plant:

The power plant has a maximum furnace thermal output of 790 MW. In addition to the regular fuels: coal, coke and petroleum coke, pyrolysis coke and pyrolysis gas can also be used.

The coke is first fed into the coal bunkers, ground together with the coal and then blown into the boiler with dust burners. The incineration of the pyrolysis product runs at temperatures of approx. 1600 °C. During the incineration, the organic agents are transformed into CO<sub>2</sub> and water. Due to the high ratio of sulphur to chlorine in the crude flue-gas, and because of the cooling to approx. 120 °C, any new formation of dioxins is prevented. All toxic agents that have not changed into their gaseous phase are bound into the melting chamber granulate together with the recycled airborne dust and the ground inert material.

Energy balance and weight assessment:

The energy and mass balance of the ConTherm plant are illustrated in the following diagram:

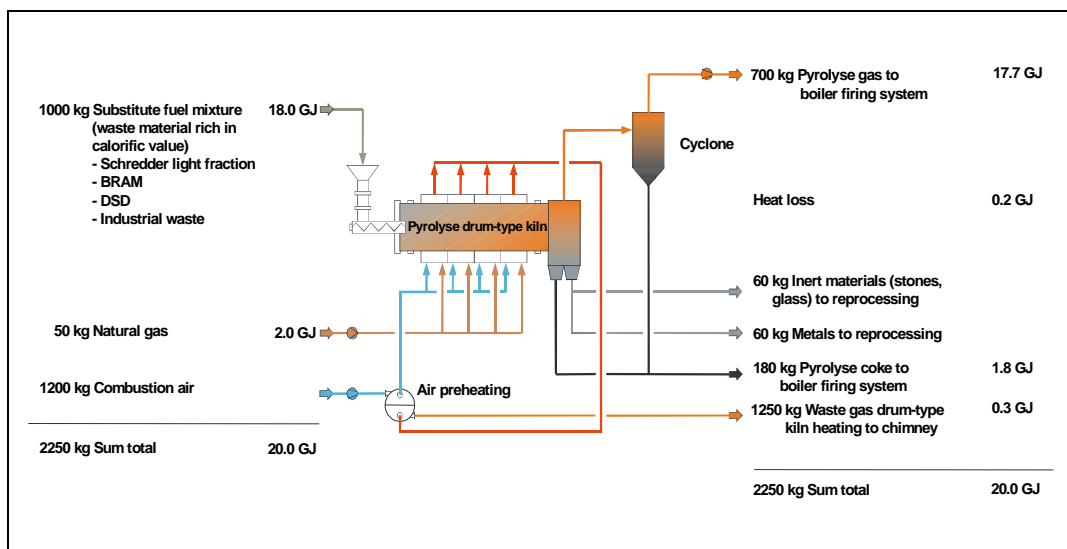

Figure 2.20: Energy balance and weight assessment of the ConTherm plant  
Source [1, UBA, 2001]



Depending on the calorific value of the RDF (e.g. 15 - 30 MJ/m<sup>3</sup>) it is possible to reduce primary fuel such as coal in the range of 0.5 to 1.0 tonne of hard coal per tonne of RDF.

Data on emissions to air were not supplied.

#### Costs:

Due to the connection of the pyrolysis plant to a coal-fired power station and the utilisation of the pyrolysis products in the power station, new installations (and hence capital costs) are limited to:

- waste reception and storage (bunker)
- the drum-type kiln system with the required heating installations, and
- the reprocessing system for valuable substances.

The power plant shares the incineration unit, waste heat utilisation system, flue-gas cleaning system and the chimney. Using the process equipment, machinery and infrastructure of the power plant results in reduced investment costs and hence reduced interest payments. In addition, staff, operation and maintenance costs are also reduced. Thus, disposal costs per tonne of waste are also reduced, and may be below those of standalone incineration plants.

[1, UBA, 2001]

### **2.3.4.4 Combination processes**

This term is used for processes consisting of a combination of different thermal processes (pyrolysis, incineration, gasification).

#### **2.3.4.4.1 Pyrolysis – incineration**

[1, UBA, 2001]

The following techniques are at various stages of development:

1. Pyrolysis in a drum-type kiln with subsequent high temperature incineration of pyrolysis gas and pyrolysis coke. In Germany, the full commissioning of a plant of this type was not completed.
2. Pyrolysis in a drum-type kiln, followed by condensation of the gaseous tars and oils, subsequent high-temperature incineration of pyrolysis gas, pyrolysis oil and pyrolysis coke.
3. Pyrolysis on a grate with directly connected high-temperature incineration.

The solid residues from these processes are granular, which can be advantageous for later reutilisation or disposal. Sewage sludge (dehydrated or dried) may be co-treated with the municipal waste fractions.

Process number 2 (above) is similar to process number 1 in principle, but differs in two main aspects:

- the pyrolysis gases are cooled on leaving the drum-type kiln, to deposit oil, dust and water
- this is followed by oxidative high-temperature treatment in a special aggregate furnace, where the pyrolysis products, oil-water-dust mixture, pyrolysis coke and pyrolysis gas are combusted, and the solid residues are transformed into a liquid melt.

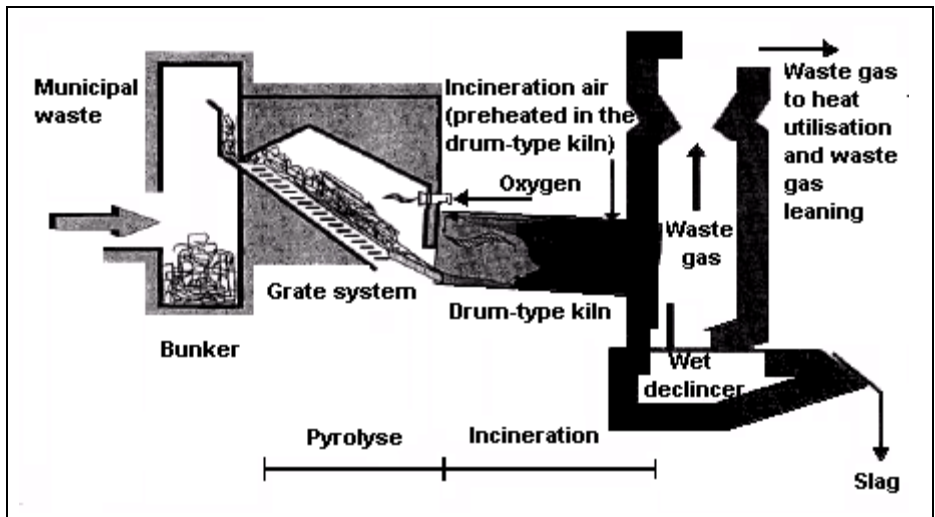

Figure 2.21: Pyrolysis on a grate with directly connected high-temperature incineration  
 Source [1, UBA, 2001]

Pyrolysis on a grate with directly connected high-temperature incineration (see Figure 2.21) was developed from conventional grate incineration but with the objective of producing a liquid melt. The wastes are first pyrolysed on a grate by direct heating. This heat originates from a partial incineration of the pyrolysis gases with pure oxygen. In a second step, the products, pyrolysis gas, coke and inert substances are combusted or melted, respectively, at high temperatures in a directly connected drum-type kiln. The accumulating melt residue contains glass, stones, metals and other inert materials and is different from the corresponding product of process 1 above.

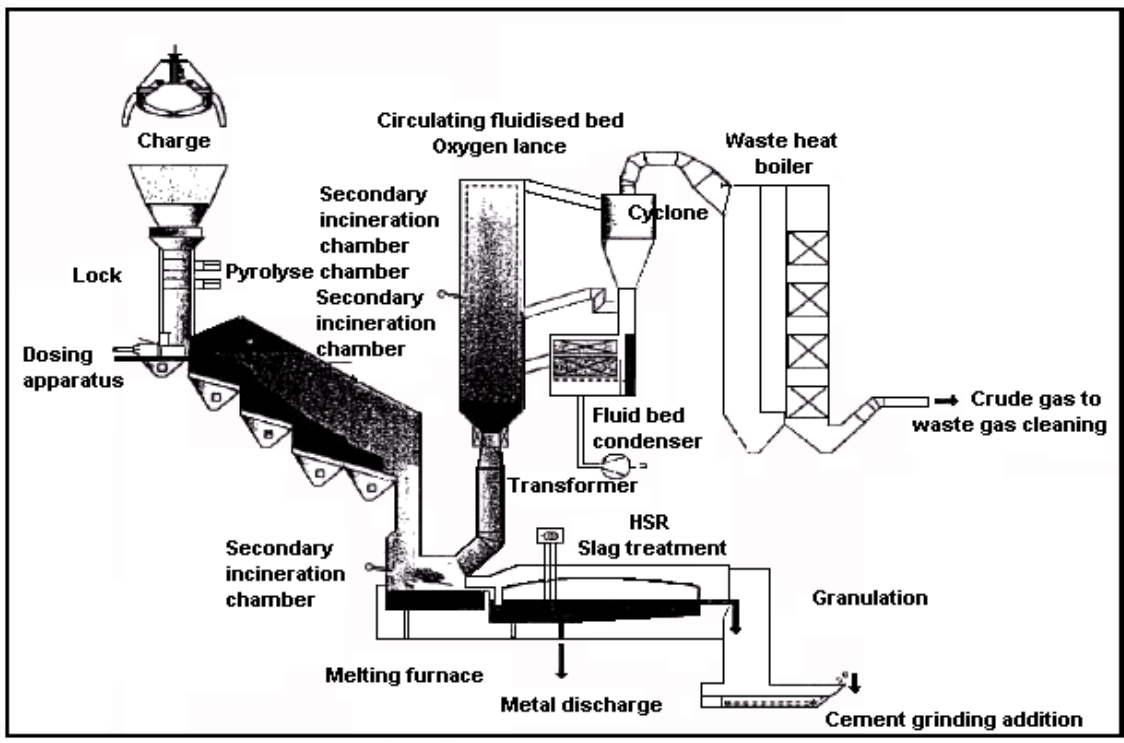

Figure 2.22: The RCP process  
 Source [1, UBA, 2001]

The RCP process (see Figure 2.22) is a development of the pyrolysis on a grate with directly connected high-temperature incineration process. The molten bottom ash is depleted of metallic components and upgraded to a cement additive in a special secondary treatment stage. In Germany, the RCP process concept is now being applied for the first time on an industrial scale at a plant with a throughput of 90000 tonnes/yr (investment costs approx. EUR 88 million) connected to an existing incineration plant for municipal wastes at Bremerhaven.

The flue-gas cleaning techniques applied for the three pyrolysis combination processes named above do not, in principle, differ from the systems used in municipal waste incineration plants. The same residues and reaction products accumulate. Their type and composition mainly depend upon the system of flue-gas cleaning selected. However, in contrast to municipal waste incineration, filter dusts can be recycled into the melting chamber.

#### Example pyrolysis – combustion installation for clinical wastes in the Netherlands:

[2, infomil, 2002]

The non-specific clinical waste is collected regularly from hospitals and other health care institutes, including doctors, dentists and veterinarians. The waste is collected in special 30 or 60 litre bins, which have been filled at the institutions and which do not need to be opened again. The waste is then incinerated, including the bins, which also act as an auxiliary fuel.

The non-clinical waste from hospitals and health care institutions is collected and treated as normal municipal waste.

The collected waste is stored in closed transport containers on-site. The bins are collected and transported semi-automatically to the incineration unit, which is located in a closed building. Feeding the incinerator is through an air lock, in order to prevent the introduction of false incineration air.

Incineration takes place in a two-stage process (see Figure 2.23). In the lower incineration room, a controlled pyrolysis occurs, followed by incineration with primary air as the waste progresses through the room. Finally, the waste ends in a water-filled ash discharger, from which the ash is removed by a chain conveyer system.

The flue-gases are incinerated with secondary air and, if required, with auxiliary fuel at a temperature level of approx. 1000 °C. Subsequently, they are cooled in a saturated steam boiler (steam temperature 225 °C, pressure 10 bar), a heat-exchanger, and a scrubber. Steam is supplied to the adjacent municipal waste incineration plant which uses the steam and returns the related boiler feed-water.

The scrubber is a two-stage system for removing acid compounds. The treated flue-gas is heated up (in a heat-exchanger and in a steam-flue-gas heat-exchanger) before passing a dust bag filter with adsorbent injection (activated carbon and lime), for removal of dioxins, and an SCR-De NO<sub>x</sub> unit. Emission concentrations of the emitted flue-gases are according to Dutch standards. The flue-gas is emitted through a 55-metre high stack.

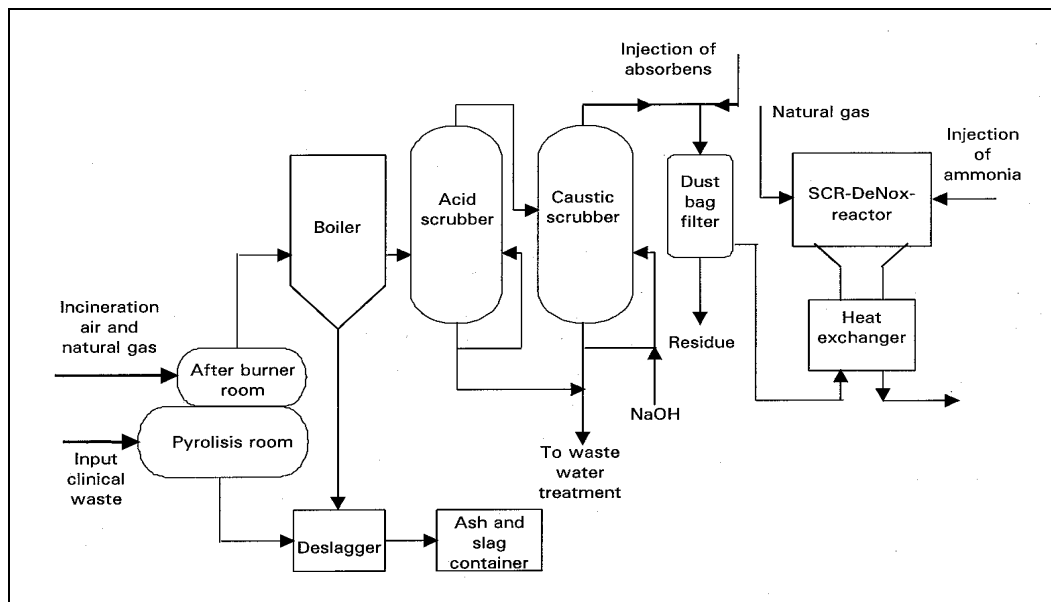

Figure 2.23: Example of a clinical waste pyrolysis-incineration plant, ZAVIN, Netherlands  
Source [2, infomil, 2002]

#### 2.3.4.4.2 Pyrolysis – gasification

[1, UBA, 2001]

Two different types of pyrolysis-gasification processes can be distinguished:

- disconnected (pyrolysis with subsequent gasification = conversion process) and
- directly connected processes.

##### Conversion process:

In the *conversion process*, metals and, if required, inert material may be removed after the pyrolysis step. As pyrolysis gas and pyrolysis coke require reheating in the gasification process, the technical and energetic requirements are higher than with *connected* processes. The condensed exhaust vapour is treated as waste water and discharged.

In the conversion process, the waste needs to be shredded and dried before it can be used in the first thermal stage. This stage more or less corresponds with that of the *Smoulder-burn* process. The subsequent stages are:

- pyrolysis in the drum
- withdrawal of solid residues
- separation of the fine fraction enriched with carbon
- sorting of the metal and inert fraction.

The pyrolysis gas is cooled to condense exhaust vapour and pyrolysis oil. It is then supplied, together with the pyrolysis oil and the fine fraction, to the second thermal stage, which is a current flow gasifying reactor. The oil and the fine fraction are gasified in the current flow at high pressure and at a temperature of 1300 °C. The resulting synthesis gas is cleaned and then combusted for energy recovery. Solid residues are withdrawn as melted granulate through a water bath. They correspond in type and quantity with those from the *Smoulder-burn* process.

A conversion plant for the treatment of 100000 tonnes/yr of municipal wastes and 16000 tonnes/yr of dehydrated sewage sludge was approved at Northeim, Lower Saxony (D).

With direct connection, there may be improved electrical generation rates, but the metals and inert material go into a melt for which no use has been found to date.

### Combined gasification-pyrolysis and melting process:

In such processes, (see Figure 2.24) the un-shredded wastes are dried in a push furnace and partially pyrolysed. From this furnace they are transferred directly and without interruption into a standing packed-bed gasifier. Here they are gasified (in the lower part) at temperatures of up to 2000 °C with the addition of oxygen. Pure oxygen is also added in the upper part of the gasification reactor to destroy the remaining organic components in the generated synthesis gas, through oxidation, gasification and cracking reactions.

Although reported to be capable of treating a wider range for wastes, this process is mainly used for municipal and non-hazardous industrial wastes. Wastes of LCV 6 - 18 MJ/kg and moisture content up to 60 % may be treated. Automotive shredder residues with a chlorine content of up to 3.5 % have been treated with approximately equal amounts of MSW [69, Thermoselect, 2003].

The synthesised gas is subjected to a gas cleaning process and then combusted to utilise the energy value. The originally solid residues leave the reactor molten. During test operations, approx. 220 kg of bottom ash with approx. 30 kg metal accumulated per tonne of waste input.

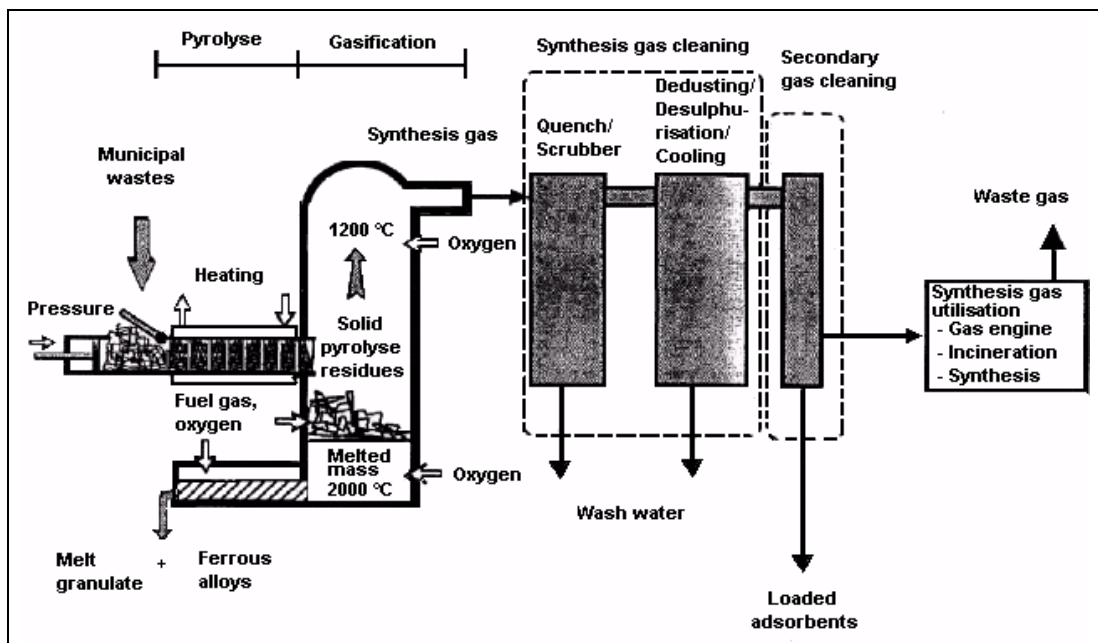

Figure 2.24: Schematic diagram of a push pyrolyser (example shown operated by Thermoselect)  
Source [1, UBA, 2001]

A plant of this type with a municipal waste throughput of 108000 tonnes/yr is currently under construction at Ansbach. Another plant with a throughput of 225000 tonnes/yr has been built at Karlsruhe (D), but has not yet achieved the design throughput. Two plants of this type are operated in Japan (2003).

2.3.4.4.3 Gasification – combustion

An example for the combination of gasification with combustion for ash melting is shown in Figure 2.25 below:

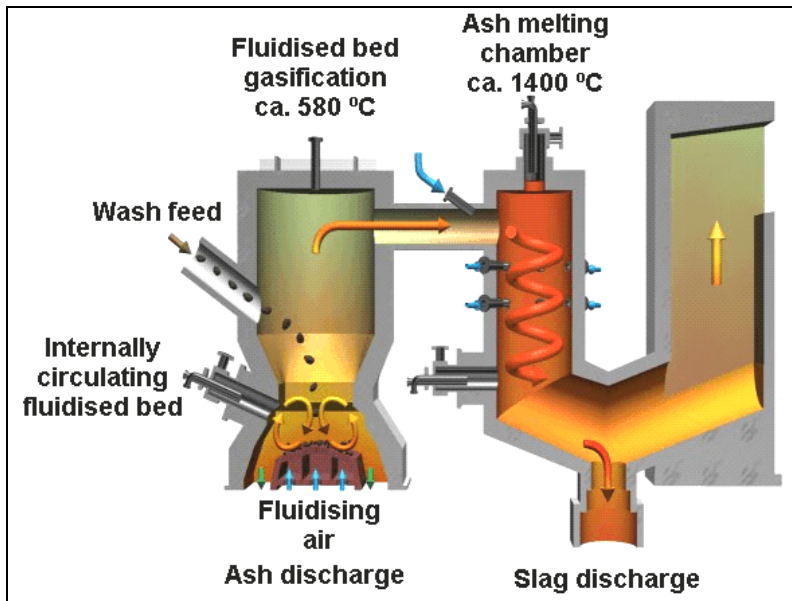

Figure 2.25: Combined fluidised bed gasification and high temperature combustion process  
Source [68, Ebara, 2003]

Shredding residues, waste plastics or shredded MSW is gasified in an internally circulating bubbling fluidised bed, which is operated at about 580 °C. Larger inert particles and metals are discharged at the bottom and separated from the bed material. The bed material is returned to the gasifier. Fine ash, small char particles and combustible gas is transferred to the cyclonic ash melting chamber, where air is added to achieve the desired temperature for ash melting (normally 1350 - 1450° C).

The ash melting chamber is an integrated part of the steam boiler, for energy recovery.

Products from this process – besides power or steam – are metals in pieces, a vitrified slag (low leaching and stable) and metal concentrates derived from the secondary ash.

Different from other gasification processes, this process is operated at atmospheric pressure and with air rather than oxygen. Pretreatment of MSW by shredding is necessary to reduce particle size to 300 mm diameter. Wastes already within this specification can be treated without shredding. In the various plants in operation, other wastes like sewage sludge, bone meal, clinical waste and industrial slags and sludges are treated in addition to MSW. [68, Ebara, 2003]

## 2.3.5 Other techniques

### 2.3.5.1 Stepped and static hearth furnaces

Static hearth furnaces consist of a refractory lined box in which the wastes burned on the base of the furnace, often with the injection of support fuels above the burning waste to help maintain temperatures. In some cases the waste loading mechanism is a simple door opening (although this is not common in modern plants due to the instability caused to the incineration process by the uncontrolled ingress of air that results) or is provided by a hydraulically operated ram, which also provides a measure of waste agitation. Such processes often operate on a batch basis, with de-ashing carried out in between batch loading. De-ash mechanisms are usually fairly simple drag systems – in older, smaller units de-ashing was carried out manually using scrapers, although this causes difficulties with air ingress to the furnace. Such, very basic technology has been widely applied, particularly to small incineration units (<250 kg/hr) but is less widely applied owing to the application of new air emission, ash burn-out etc legislation, which such systems cannot meet in the majority of circumstances. Such systems have been used in some cases to provide a means for the disposal of dead animals, animal parts, packaging wastes and some clinical wastes – but generally only at the low throughput rates noted above.

Stepped hearth systems are a development from static hearths. They consist of a usually 2 to 4 static hearths arranged as a series of steps. The waste is generally pushed forward through the furnace and over the steps using hydraulic rams. The pushing and tumbling of the waste provided agitation and allows improved burnout. Such systems continue to be applied, particularly at plants of below 1 t/hr. Loading mechanisms are generally air sealed hoppers or hydraulic batch loaders. De-ashing is generally continuous, and maybe via a water batch to provide an air seal and prevent air ingress to the furnace. Such systems are capable of reaching modern legislative requirements with some waste types. Burnout of the waste may be variable and highly dependent of the waste type – pretreatment of the waste by shredding usually assists in reaching required burnout standards.

### 2.3.5.2 Multiple hearth furnaces

Multiple hearth incinerators are mainly applied to the incineration of sludges (e.g. sewage sludge).

The multiple hearth furnace (see Figure 2.26) consists of a cylindrical lined steel jacket, horizontal layers, and a rotating sleeve shaft with attached agitating arms. The furnace is lined with refractory bricks. The number of trays for drying, incineration, and cooling is determined based on the residual material characteristics. The multiple hearth furnace is also equipped with a start-up burner, sludge dosing mechanism, circulation-, sleeve shaft- and fresh air - blowers.

Sewage sludge is fed at the top of the furnace and moves downwards through the different hearths countercurrent to the combustion air, which is fed at the bottom of the furnace. The upper hearths of the furnace provide a drying zone, where the sludge gives up moisture while the hot flue-gases are cooled.

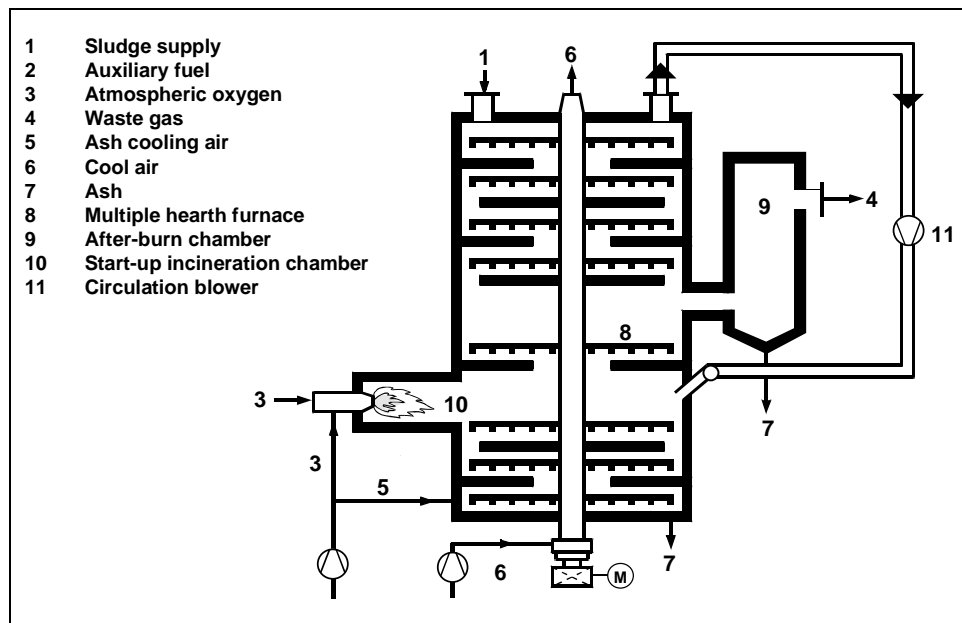

**Figure 2.26: Principle function of a multiple hearth furnace**  
 Source [1, UBA, 2001]

The material to be incinerated is supplied at the highest furnace layer. It is captured by agitator sprockets, divided, and forced through the furnace layers through constant rotation. In a counter-direction to the sludge, hot flue-gas is conducted from the highest incineration layer via the drying layers. The sludge is dried by the flue-gas and heated to ignition temperature. The circulating air is augmented with steam and volatile particles during the drying process. It is then lead towards the lowest incineration layer.

The incineration mainly takes place on the central hearths. The incineration temperature is limited to 980 °C, as above this temperature the sludge ash fusion temperature will be reached and clinker will be formed. In order to prevent leakage of hot toxic flue-gases, multiple hearth furnaces are always operated at a slight vacuum pressure.

The conversion of organic sludge particles into CO<sub>2</sub> and H<sub>2</sub>O occurs at temperatures of between 850 and 950 °C. If the desired incineration temperature cannot be reached independently, a start-up burner is used for support incineration. As an alternative, solid auxiliary fuel can be added to the sludge. The ash is cooled to approximately 150 °C at the lower layers of the furnace with counter-flowing cool air and the ash is removed via the ash system. The flue-gas that is produced is fed through a post-reaction chamber with a guaranteed residence time of two seconds. Carbon compounds that have not been converted are oxidised here.

The multiple hearth furnace is employed with sludge where the ash forms such low eutectics with the fluidised bed material that it would cause operational problems in the fluidised bed furnace.

Multiple hearth furnaces can be operated by removing the flue-gases at the highest drying level and then feeding them to an post-combustion (e.g. in an incineration chamber). This is advantageous at such locations where boiler plants are already available, facilitating the feeding of flue-gases into those plants. The after-burning process and the flue-gas cleaning occur at those plants.



The essential operational parameters are shown in the following table:

Operational parameters	Units	Values
Evaporation capacity	kg/m <sup>2</sup> h	25 – 45
Heat conversion in incineration layers	GJ/m <sup>2</sup> h	0.4 – 0.6
Incineration end temperature	°C	850 – 950
Residence time, free space, and after-burn zone	sec.	min. 2
Atmospheric oxygen preheating	°C	max. 600

**Table 2.8: Operational criteria for a multiple hearth furnace**  
Source [1, UBA, 2001]

Figure 2.27 below shows a practical example of a sewage sludge incineration plant with a capacity of 80000 tonnes/yr.

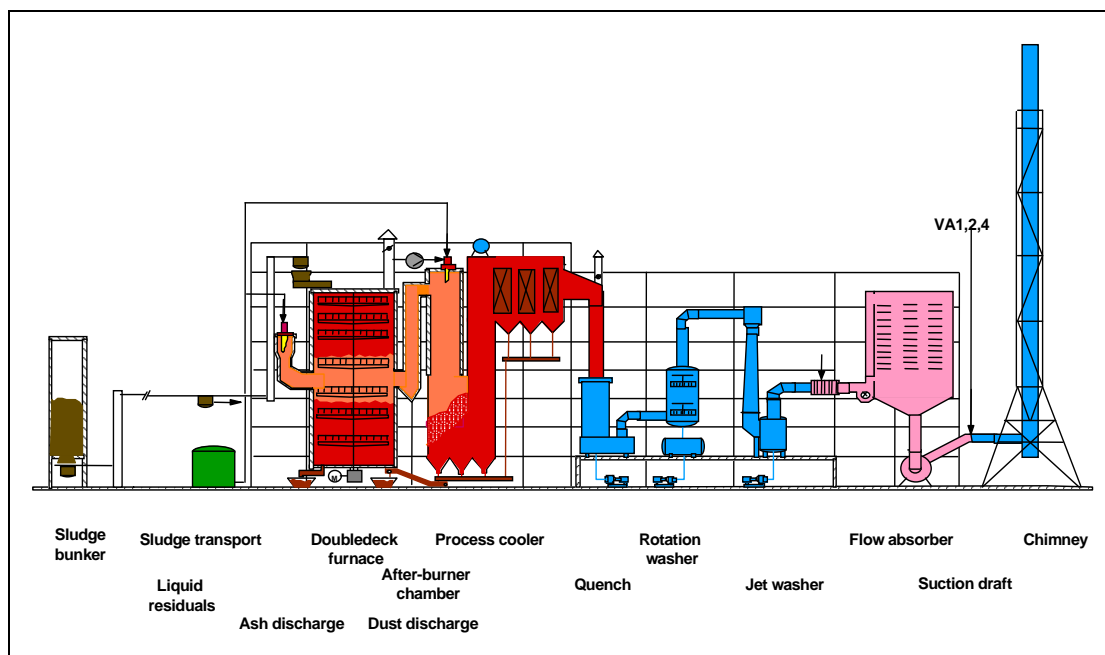

**Figure 2.27: Example of a sewage sludge incineration plant with a multiple hearth furnace**  
Source [1, UBA, 2001]

The above plant essentially consists of the following parts:

- multiple hearth furnace
- post-combustion chamber
- waste water boiler for heat utilisation
- multiple stage flue-gas cleaning.

The accumulated sewage sludge is conditioned, meaning that it is converted into a form suitable for filtering using additives or other measures. The sludge is drained as much as possible in chamber filter presses and then temporarily stored in a bunker. From there, the press cake is deposited in buckets via a bucket loader. These buckets have a capacity of approximately 1.5 tonnes each. The sludge is loaded from the buckets into a filler container at the highest layer of the incineration plant and continuously fed into the furnace. Up to 12 tonnes of sewage sludge can be processed per hour. This represents the contents of eight buckets.

### 2.3.5.3 Multiple hearth fluidised bed furnace

Several layers are installed into the freeboard of a stationary fluidised bed, enabling the sludge to be pre-dried with flue-gas. Using this pre-drying process, only a small amount of water must be evaporated in the actual fluidised bed, meaning that the grate surface and entire furnace can be reduced.

Uniform incineration is promoted in the multiple hearth fluidised bed furnace by optimising air supply, sand addition, and evaporation in the layers and in the fluidised bed. Higher temperatures (temperature differences between the furnace head and foot) can be avoided leading to a lower formation of NO<sub>x</sub>.

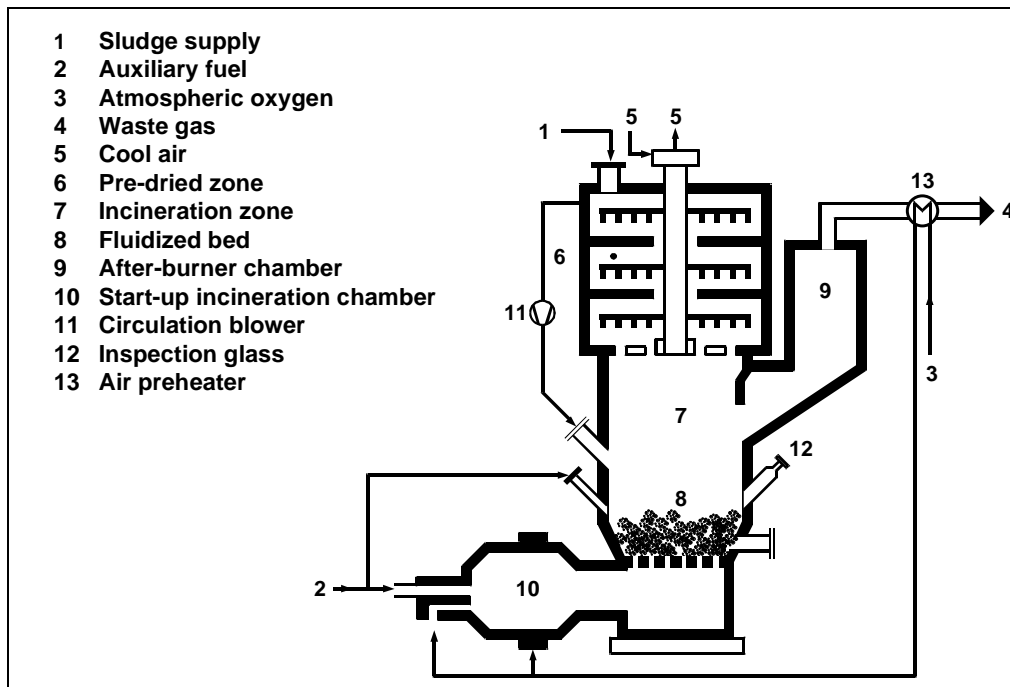

Figure 2.28: Principle function of a multiple hearth fluidised bed furnace  
 Source [1, UBA, 2001]

### 2.3.5.4 Modular systems

[Bontoux, 1999 #7]

Waste incineration can occur in a selective manner in smaller facilities that are dedicated to:

- specific kinds of wastes, or
- specifically pretreated wastes.

These specialised forms of waste incineration are often performed in commercial or industrial tailor-made facilities that usually receive consistent waste streams. As a result, they usually benefit from optimised operating conditions and treat a much smaller tonnage of waste than mass burn facilities.

One of the designs used is the “starved air” or “two-stage” incinerator in which wastes are partially burned and partially pyrolysed at the front end of a hearth with the resulting char being fully burned out at the back end.

Depending on the furnace design, various wastes are treated in such systems. (Energos 2002) As well as dealing with specific industrial non-hazardous waste streams (e.g. packaging and paper wastes, fish industry) modular semi-pyrolytic processes are also successfully applied to pretreated (shredded) municipal wastes. Plants in the range of 35000 - 70000 tonnes per year are operational in Europe. It is reported that these achieve  $\text{NO}_x$  emissions below  $100 \text{ mg/m}^3$ , without specific  $\text{NO}_x$  abatement, mainly through careful attention to combustion design and control. Whilst costs per unit disposal for mass burn facilities of this size are generally very high, the cost of systems dealing with specific waste streams is greatly reduced through a combination of:

- simple small scale gas cleaning systems may be used as flue-gas variation is reduced
- positioning of plants adjacent to heat users to increase energy supply and income which can then offset incoming disposal costs.

### 2.3.5.5 Incineration chambers for liquid and gaseous wastes

Incineration chambers are designed specifically for the incineration of liquid and gaseous wastes, as well as solids dispersed in liquids (see Figure 2.29) A common application of incineration chambers is in the chemical industry for the incineration of liquid and process off-gas. With chloride-containing wastes, HCl may be recovered for use.

All post-combustion chambers in hazardous waste incineration plants are essentially incineration chambers. In one plant (Ravenna, Italy) the post-combustion chamber is so large that the total thermal process can occur there.

Operational temperatures are usually chosen to ensure good destruction of the wastes fed to the chamber. In some cases catalytic systems are used for specific waste streams, these run at reduced temperatures of  $400 - 600 \text{ }^\circ\text{C}$ . In general, temperatures in excess of  $850 \text{ }^\circ\text{C}$  are selected for non-catalytic chambers. Support fuels are frequently used to maintain steady combustion conditions. Heat recovery may be used to supply hot water/steam via a boiler system.

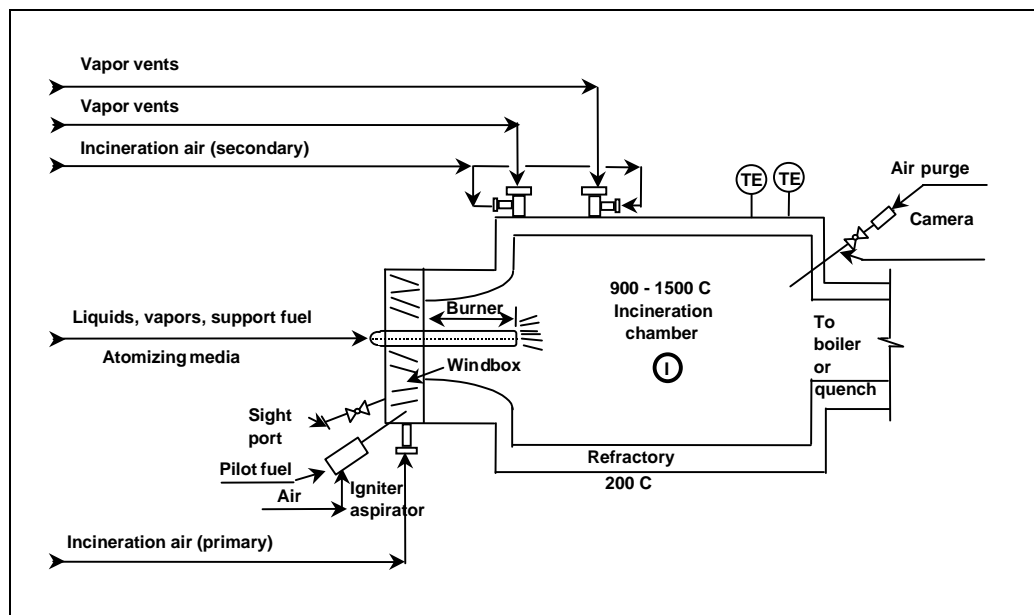

Figure 2.29: Principle of an incineration chamber for liquid and gaseous wastes  
Source [1, UBA, 2001]

### 2.3.5.6 Cycloid incineration chamber for sewage sludge

The cycloid incineration chamber was originally developed for incinerating old coke derived from flue-gas cleaning at waste incineration plants but is now also used for the thermal disposal of sewage sludge. The optimal particle size for fuel ignition lies between 1 and 5 mm. Therefore, only dried sewage sludge granules can be used.

The fuel granules are supplied gravimetrically via a radial chute into the lower part of the incineration chamber, which is designed as a metallic air-cooled hopper. Atmospheric oxygen is blown into the incineration chamber at various air levels: The primary air enters the furnace at an angle through the lower part of the hopper, and the secondary air is injected on different levels through tangentially placed jets above the fuel feed. The distribution of primary and secondary air varies according to the specific fuel characteristics.

The incineration of sewage sludge requires an even temperature distribution of between 900 and 1000 °C throughout the entire incineration chamber. Using this method, the temperature of the ash is maintained under its softening point. Flying dust is removed along with flue-gas from the incineration chamber. The coarse kernels circulate in the tangential flow field until they are incinerated to the point that they can be removed as fine kernels. Crude ash, remaining coke, or metallic parts will be removed in a downward direction via a lock system.

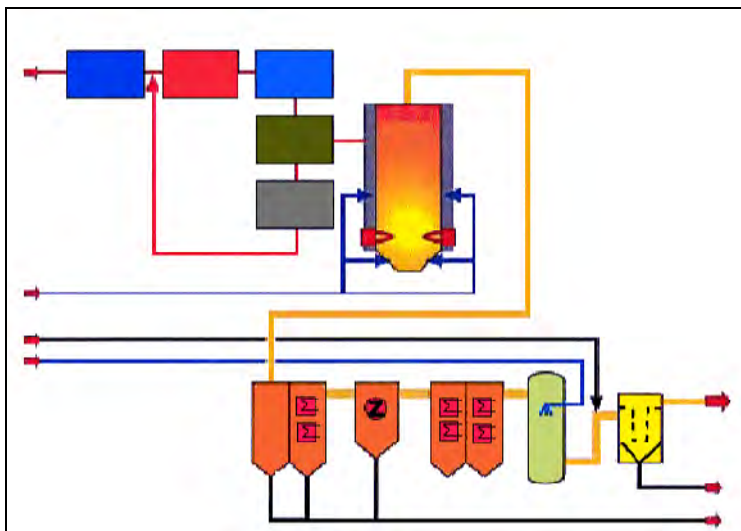

**Figure 2.30: Illustration of a cycloid furnace**  
Source [1, UBA, 2001]

### 2.3.5.7 Example of process for the incineration of liquid and gaseous chlorinated wastes with HCl recovery

[1, UBA, 2001] The process includes:

- the incineration chamber
- steam generator
- flue-gas cleaner combined with hydrochloric acid recovery and
- the flue-gas chimney (see Figure 2.31).

The plant treats liquid and gaseous chlorinated wastes using waste heat and produces hydrochloric acid.

Heat is converted into steam in the steam generator (212 °C, 20 bar) and transferred, for distribution. The particulate content of the flue-gases produced during incineration is separated, to produce the highest possible concentration of hydrochloric acid in the flue-gas cleaning plant. The removal and utilisation of hydrochloric acid normally occurs within the plant.

Gaseous residual substances (flue-gases) are fed to the recovery plant via transfer pipelines. Each flue-gas flow is conducted through a separate deposit container before incineration. Liquid particles are separated from the flue-gas flow in this deposit container. The feed lines are equipped with the appropriate flashback safety guards, according to the classification of the flue-gases. The number of feed lines depends on the control mechanisms. The volume flow is collected via flow measurements that are pressure and temperature compensated. The flue-gases are fed into the incineration chamber via a pressure regulator with a maximum pressure limit control. In addition, all flue-gas lines to the incineration chamber are equipped with automatic emergency shutdown valves.

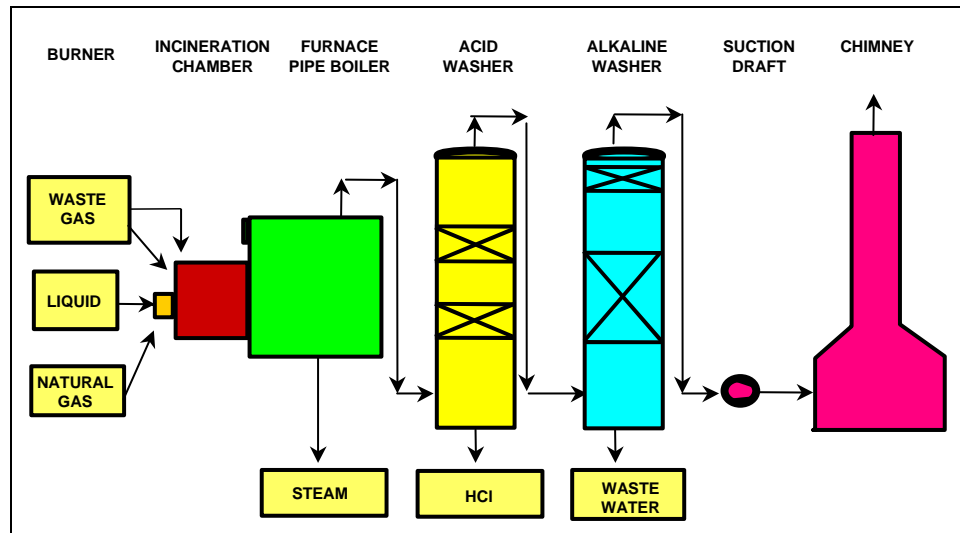

Figure 2.31: Diagram of a plant for HCl-extraction from residual gases and liquid halogenated wastes

Source [1, UBA, 2001]

Transfer pipelines for the liquid wastes are also equipped with automatic emergency shutdown valves. All liquid wastes are conducted to a multi-material burner that is situated at the front side of the incineration chamber. Vaporisation of these liquids occurs via pressured air and/or steam that have been fed into the burner under a separate gas quantity control. In addition, various flue-gas flows are fed into the multi-material burner through lances. Each of these lances consists of concentric pipes. Several flue-gas flows can thus be fed separately into the incineration chamber. For cooling and to avoid corrosion, the lances are continuously sprayed with air through the outer circular gap.

Primary energy (natural gas) is required for the plant start-up and to maintain the desired temperature in the incineration chamber. It is also fed to the multi-material burner by a separate blast connection. The flow of natural gas is regulated via a quantity control and is fed into the burner using a pressure regulator depending on the temperature in the incineration chamber. Natural gas is also required for the ignition flame that ignites the multi-material burner. Two automatic emergency shutdown valves with automatic gap releases can be found in the natural gas line to the multi-material burner and to the ignition flame.

Two independent flame-failure alarms (UV and IR) are installed to monitor the burner flame. In addition, the burner flame can be observed through inspection windows and with the help of a television camera installed on the back wall of the waste heat boiler. The amount of air is recorded with the appropriate gauges, as well as with pressure produced from a blower.

The cylindrical incineration chamber is designed in such a way that the wastes will have sufficient residence time to guarantee flawless incineration in relation to an operational temperature higher than 1100 °C during normal operation. The incineration chamber has been designed for a temperature of 1600 °C. The operational temperature is monitored continuously by thermal elements. Based on this high temperature, the whole incineration chamber, up to the entrance to the steam boiler plant, is lined exclusively with refractory bricks. The incineration chamber shell is made of boiler plate. The wet cleaning of the flue-gases occurs in two wash towers with a simultaneous recovery of technically re-usable hydrochloric acid with the highest concentration. The deployment of chlorinated wastes facilitates the recovery of approximately 5 – 20 % hydrochloric acid.

### **2.3.5.8 Example of a process for the incineration of highly chlorinated liquid wastes with chlorine recycling**

[2, infomil, 2002]

This incineration unit for highly chlorinated liquid wastes (chlorinated hydrocarbons) is located on an industrial site. The total plant capacity is approx. 36000 t/yr. The processed waste originates on site, as well as from external customers. Wastes are limited in their content of solids (<10g/kg), fluorine, sulphur and heavy metals. PCBs are also treated.

Incineration takes place in two furnaces at a temperature level of 1450 – 1550 °C (gas residence time 0.2 – 0.3 sec). This temperature level can normally be maintained without auxiliary fuel. Water is injected in order to suppress the formation of Cl<sub>2</sub>. After leaving the furnace, the flue-gas passes through a quench section, where the temperature is lowered to approx. 100 °C. Insoluble matter and heavy metal salts are removed from the circulating liquid in a quench tank. The flue-gas continues through an isothermal and an adiabatic absorber. The recuperated hydrochloric acid is distilled at elevated pressure and temperature, after which the gas is cooled down to –15 °C in order to reduce the water content to practically zero. The recovered anhydrous HCl is reprocessed in a vinyl-chloride-monomer plant.

Flue-gases pass through an alkaline scrubber and an activated carbon filter (for dioxin absorption). TOC, HCl NO<sub>x</sub>, O<sub>2</sub>, CO and dust are continuously analysed. The concentration of dioxins and PCBs in emissions is below 0.1 ng TEQ/Nm<sup>3</sup>. Other emissions to air comply with Dutch emission limit values.

The effluent from the quench and the scrubber unit is treated in a physical/chemical unit and in a biological waste water treatment unit. Dioxin content is <0.006 ng TEQ/l. PCBs are below the detection limit (<10 ng/l).

A scheme of the process is given in Figure 2.32.

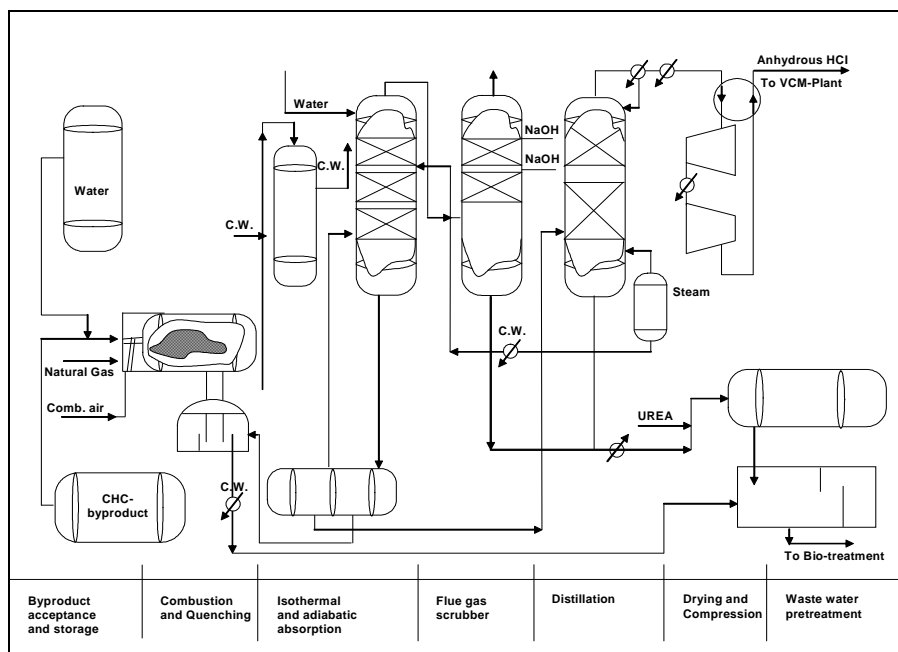

**Figure 2.32: Process scheme of a chlorine recycling unit operated by Akzo Nobel**  
Source [2, infomil, 2002]

The main advantage of this dedicated incineration unit is that chlorine can be recovered. Also in this case, overhead costs are reduced by the fact that it is part of a larger chemical plant.

### 2.3.5.9 Waste water incineration

[1, UBA, 2001]

Waste water can be cleaned through incineration of the organic content materials. This is a special technology for the treatment of industrial waste water where organic and sometimes inorganic waste water content material is chemically oxidised with the help of atmospheric oxygen with the evaporation of the water, at high temperatures. The term “gas phase oxidation” is used to differentiate this type of incineration from other technologies, such as wet oxidation. The process of gas phase oxidation is used if the organic substances in the water cannot be re-used or if their recovery is not economical or another technique is not applied.

Waste water incineration is an exothermic process. Independent incineration can only take place if the organic load is sufficient to evaporate the water share independently and to perform superheating. Therefore, waste water incineration plants normally require the use of support fuels for low organic load wastes. Reduction of the requirement for additional energy can be achieved by reducing water content. This can be achieved through deployment of a pre-connected, or multi-step, condensation plant. In addition, a heat recovery part (boiler) can be installed to recover steam for condensation from the furnace heat that is produced.

Depending on the individual organic and inorganic content of the waste water and the various local conditions, very different plant designs result.

Waste water and fuel are injected via burners or lances at several locations within the incineration chamber. Atmospheric oxygen is also supplied at several locations (primary air = atmospheric oxygen combined with fuel, secondary air = mixed air).

An example of an waste water incinerator with a waste water evaporation (concentration) unit is shown in the following figure below [74, TWGComments, 2004]

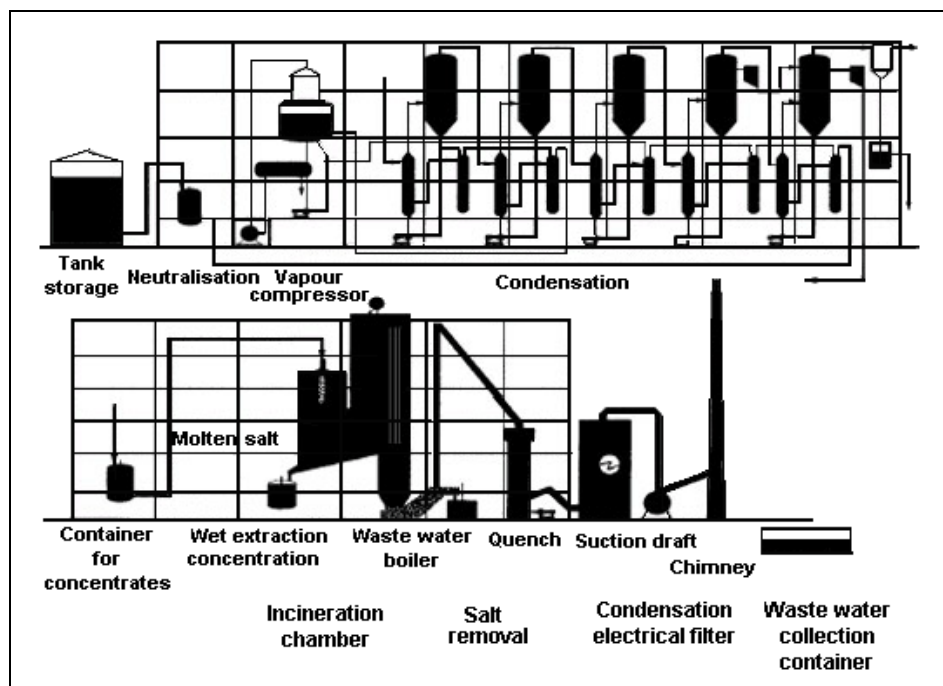

**Figure 2.33: Example of a waste water incinerator with a waste water evaporation (concentration) unit.**

Source [1, UBA, 2001]

Example of an installation for the incineration for caustic waste water:

[2, Infomil, 2002]

Caustic water is a specific waste water stream from MSPO plants (Mono-Styrene Propylene-Oxide). This water is produced in several washing steps in the process. It contains approximately 10 % to 20 % organic components and has a high sodium load (mainly NaCl).

Both the high organic fraction and the sodium make it difficult or even impossible to use biological water treatment. The caloric value of this water is too low for unsupported incineration, so co-incineration or the use of supporting fuel is necessary. The high sodium content, together with the large quantities, can cause problems for co-incineration in municipal waste incinerators.

Applicable treatment technologies are wet oxidation and incineration. For this purpose, four static vertical incinerators (total capacity approx. 350 – 400 kt/yr) are used in this example, which have been in operation since 1999/2000.

The incinerators are static vertical top-down incinerators. The low caloric waste (caustic water with 10 – 20 % organics) can be led through a falling film evaporator. This evaporator operates on excess low-pressure steam, which comes from the incinerator wall cooling, thus using less fuel in the incinerator.

The remaining liquid and the produced vapour are incinerated with natural gas and/or high caloric liquid fuel (waste or fuel oil). The resulting flue-gases are partially cooled by a membrane wall, producing steam of 27 bar. Subsequently the flue-gases are quenched to clean the gases of sodium salts and other water soluble impurities.

In the heat recovery section, re-circulation water is sprayed over the flue-gases. This re-circulation water flashes out in the flash chamber, generating approximately 30 t/h of steam per unit.



After the heat recovery the flue-gases pass through a venture scrubber and a wet electrostatic precipitator where aerosols and dust are removed.

The incinerators operate at a temperature of 930 – 950 °C, with low excess air (3 – 4 % O<sub>2</sub>). Depending on the concentration of organics, the throughput of caustic water is 10 – 15 t/h per unit.

The water from the quench is treated in ion-exchange beds to remove heavy metals. Special ion-exchange beds concentrate the Molybdenum (catalyst in the MSPO process) to a re-usable grade.

The main advantage of these incinerators is the possibility to incinerate large quantities of low caloric waste with high salt concentrations.

The following diagram shows an example plant for this process:

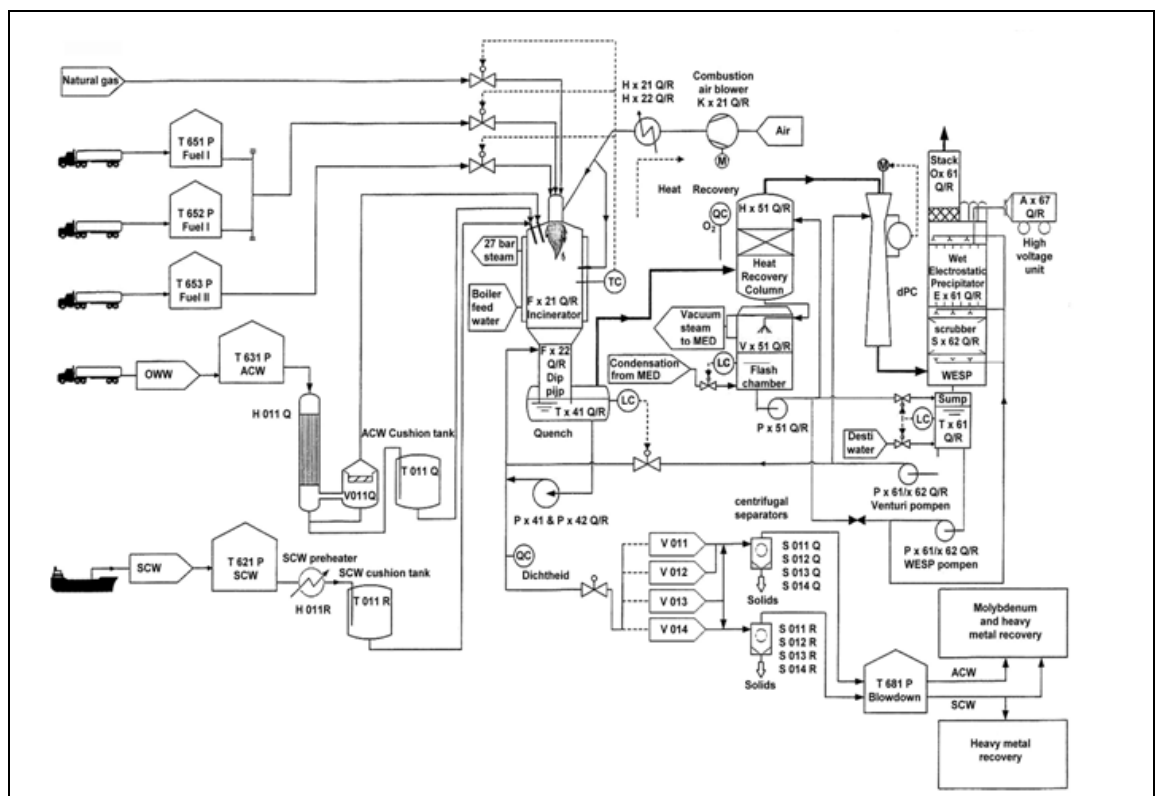

Figure 2.34: Process scheme of a caustic water treatment plant operated by AVR  
Source [2, Infomil, 2002]

### 2.3.5.10 Plasma technologies

Plasma is a mixture of electrons, ions and neutral particles (atoms and molecules). This high temperature, ionised, conductive gas can be created by the interaction of a gas with an electric or magnetic field. Plasmas are a source of reactive species, and the high temperatures promote rapid chemical reactions.

Plasma processes utilise high temperatures (5000 to 15000 °C), resulting from the conversion of electrical energy to heat, to produce a plasma. They involve passing a large electric current through an inert gas stream.

Under these conditions, hazardous contaminants, such as PCBs, dioxins, furans, pesticides, etc., are broken into their atomic constituents, by injection into the plasma. The process is used to treat organics, metals, PCBs (including small-scale equipment) and HCB. In many cases pretreatment of wastes may be required.

An off-gas treatment system depending on the type of wastes treated is required, and the residue is a vitrified solid or ash. The destruction efficiencies for this technology are quite high, >99.99 %. Plasma is an established commercial technology, however the process can be very complex, expensive and operator intensive.

Thermal plasmas can be generated by passing a DC or AC electric current through a gas between electrodes, by the application of a radio frequency (RF) magnetic field without electrodes, or by application of microwaves. Different kinds of plasma technologies are introduced below:

### **1. Argon plasma arc**

This is an “in flight” plasma process, which means that the waste mixes directly with the argon plasma jet. Argon was selected as the plasma gas since it is inert and does not react with the torch components.

The destruction and removal efficiency (DRE) is reported to exceed 99.9998 % for destroying ozone depleting substances (ODS) at 120 kg/h and with 150kW electrical power.

The advantage of this technology over some other plasma systems is that it has demonstrated high efficiency destruction of both CFCs and halons on a commercial scale for several years. It has also demonstrated low emissions of PCDD/F. Mass emissions of pollutants are also low because of the relatively low volume of flue-gas produced by the process. Also, the very high energy density results in a very compact process that may easily be transported.

### **2. Inductively coupled radio frequency plasma (ICRF)**

In ICRF applications, inductively coupled plasma torches are used, and energy coupling to the plasma is accomplished through the electromagnetic field of the induction coil. The absence of electrodes allows operation with a large range of gases, including inert, reducing or oxidizing atmospheres and better reliability than plasma arc processes.

The ICRF plasma process has demonstrated a DRE exceeding 99.99 % while destroying CFC at a rate of 50 - 80 kg/h.

The process is reported to have been demonstrated on a commercial scale to achieve high destruction of CFC and low emission of pollutants. The ICRF plasma does not require argon and may therefore cost less to operate than other similar systems. In addition, the low volume of gas produced by the process results in low levels of mass emission of pollutants.

### **3. AC plasma**

The AC plasma is produced directly with 60 Hz high voltage power but in other respects is similar to the inductively coupled RF plasma. The system is electrically and mechanically simple and is thus claimed to be very reliable. The process does not require argon and can tolerate a wide variety of working gases, including air, or steam as plasma gases and is claimed to be tolerant of oil contamination in ODS.

### **4. CO<sub>2</sub> plasma arc**

A high temperature plasma is generated by sending a powerful electric discharge into an inert atmospheric gas, such as argon. Once the plasma field has been formed, it is sustained with ordinary compressed air or certain atmospheric gases depending on desired process outcomes.

The temperature of the plasma is well over 5000 °C at the point of generation into which the liquid or gaseous waste is directly injected. The temperature in the upper reactor is about 3500 °C and decreases through the reaction zone to a precisely controlled temperature of about 1300 °C.

A special feature of the process is the use of CO<sub>2</sub>, which is formed from the oxidation reaction, as the gas to sustain the plasma.

The process has demonstrated high DREs with refractory compounds at a reasonably high demonstration rate. Mass emission rates of the pollutants of interest are low, primarily because of the low volume of flue-gas produced by the process.

### **5. Microwave plasma**

This process feeds microwave energy at 2.45 GHz into a specially designed coaxial cavity to generate a thermal plasma under atmospheric pressure. Argon is used to initiate the plasma but otherwise the process requires no gas to sustain the plasma.

The DRE for the microwave plasma process is reported to exceed 99.99 % while destroying CFC-12 at a rate of 2 kg/h.

The process is reported to have a high destruction efficiency and to be capable of achieving the high operating temperatures in a very short time, thus providing operating flexibility and reduced downtime.

There is no need for an inert gas to operate the process, which improves the power efficiency, reduces operating cost, as well as reducing the volume of flue-gas produced. In addition, the process is very compact.

### **6. Nitrogen plasma arc**

This process uses a DC non-transferred plasma torch operating with water cooled electrodes and using the nitrogen as the working gas generates the thermal plasma. The process was developed in 1995 and there are commercial systems available.

The process is reported to achieve a DRE of 99.99 % while destroying CFCs, HCFCs and HFCs at a feed rate of 10 kg/h.

A key advantage of this technology is that the equipment is very compact in size. The system requires only 9 m x 4.25 m area for installation, which includes space for a precipitation and dehydration unit for the by-products (CaCl<sub>2</sub> and CaCO<sub>3</sub>). Therefore, the system is capable of being carried on a truck to the waste generation spot, leading to an on-site treatment.

## **2.3.5.11 Various techniques for sewage sludge incineration**

### **Typical process conditions applied to sewage sludge incineration:**

In addition to sewage sludge, other wastes from the waste water treatment process are often incinerated e.g. swim scum, screenings, and extracted fats.

Plants receiving partially dried sludge require less additional fuels than raw sludges. The heat values of the sludge for auto thermal incineration lie between 4.8 MJ/kg and 6.5 MJ/kg. Values between 2.2 MJ/kg and 4.8 MJ/kg sludge are seen where raw sewage is treated. Approximately 3.5 MJ/kg sludge is considered the limit for auto thermal incineration. The need for additional fuel can be reduced by the use of efficient internal energy recovery systems e.g. recovery of heat from flue-gases to heat incineration air and/or use of heat to provide for sludge drying.

Used oil is the mainly used additional fuel in mono-sewage sludge incinerators. Heating oils, Natural gas, coal, solvents, liquid and solid waste and contaminated air are also used. Contaminated gas is preferred for the incineration of digested sludge.

The primary influences on the requirement for additional energy are the air preheating and degree of drainage needed. The influence of conditioning agents is relatively low.

Dedicated sewage sludge incinerators are generally designed and operated at temperatures between 850 and 950 °C. Temperatures below 850 °C can result in odour emissions, while temperatures above 950 °C may result in ash fusion. Gas residence times of in excess of 2 seconds are commonly employed.

The temperature level achieved during incineration depends mainly on the energy content and the amount of sewage sludge to be incinerated and on the atmospheric oxygen level.

There are some examples of sewage sludge incinerators (often fluidised bed processes) that operate at temperatures closer to 820 °C without a deterioration in incineration performance or increased emissions.

**Comparison of furnace systems for sewage sludge incineration:**

The described furnace systems function according to different process technologies. The furnace structure, design, and operational technology of the incineration plant, the resulting post-connected cleaning equipment, as well as the transport of different material flows, all have a significant influence on the resulting emissions. The characteristics of the various furnaces are shown in the following table:

	<b>Fluidised Bed Furnace</b>	<b>Multiple hearth Furnace</b>	<b>Multiple hearth Fluidised Bed Furnace</b>	<b>Cycloid Furnace</b>
<b>Main features of technique</b>	<ul style="list-style-type: none"> <li>no mechanically moveable parts and low wear.</li> </ul>	<ul style="list-style-type: none"> <li>no separate pre-drying is necessary</li> <li>extensive furnace structure with moveable parts</li> <li>cooled hollow shaft</li> </ul>	<ul style="list-style-type: none"> <li>no separate pre-drying is necessary</li> <li>moveable hollow shaft</li> <li>low fluidised bed volume.</li> </ul>	<ul style="list-style-type: none"> <li>no mechanically moveable parts and low wear</li> <li>no fluidised bed material.</li> </ul>
<b>Operational aspects</b>	<ul style="list-style-type: none"> <li>fast start-up and shut-down through short heating- and cooling times, intermittent operation possible</li> </ul>	<ul style="list-style-type: none"> <li>long heating time, continuous operation necessary</li> </ul>	<ul style="list-style-type: none"> <li>medium heating- and cooling time</li> </ul>	<ul style="list-style-type: none"> <li>comparable to the fluidised bed</li> <li>deployable for a wide range of wastes</li> </ul>
<b>Possible operational problems</b>	<ul style="list-style-type: none"> <li>agglomeration, de-fluidisation.</li> </ul>		<ul style="list-style-type: none"> <li>possible emissions of organics, movable parts in the furnace.</li> </ul>	<ul style="list-style-type: none"> <li>maintaining desirable temperature</li> </ul>
<b>Incineration stage main features</b>	<ul style="list-style-type: none"> <li>low air surplus required</li> <li>complete incineration only above the fluidised bed</li> </ul>	<ul style="list-style-type: none"> <li>incineration difficult to control</li> <li>immune to fluctuations in loads and coarse material</li> </ul>	<ul style="list-style-type: none"> <li>low air surplus required</li> <li>good incineration control</li> <li>incineration completed within the fluidised bed</li> <li>greater immunity to quality fluctuations in the sludge than fluidised bed furnaces.</li> </ul>	<ul style="list-style-type: none"> <li>solid material shares</li> <li>long and gaseous shares</li> <li>short residence times</li> <li>variable primary and secondary air supply on several levels.</li> </ul>
<b>Ash content in flue-gas</b>	<ul style="list-style-type: none"> <li>high</li> </ul>	<ul style="list-style-type: none"> <li>low</li> </ul>	<ul style="list-style-type: none"> <li>high</li> </ul>	<ul style="list-style-type: none"> <li>high</li> </ul>
<b>Ash removal</b>	<ul style="list-style-type: none"> <li>via flue-gas flow and sand removal</li> </ul>	<ul style="list-style-type: none"> <li>directly from the lowest level</li> </ul>	<ul style="list-style-type: none"> <li>via flue-gas flow and sand removal</li> </ul>	<ul style="list-style-type: none"> <li>via flue-gas flow</li> <li>crude ash at the bottom</li> </ul>
<b>Residues</b>	<ul style="list-style-type: none"> <li>ash</li> <li>fluidised bed material</li> </ul>	<ul style="list-style-type: none"> <li>ash</li> </ul>	<ul style="list-style-type: none"> <li>ash</li> <li>fluidised bed material</li> </ul>	<ul style="list-style-type: none"> <li>ash</li> <li>possibly coarse ash</li> </ul>

**Table 2.9: Comparison of furnace systems for sewage sludge incineration**  
Source [1, UBA, 2001]

## 2.4 The energy recovery stage

### 2.4.1 Introduction and general principles

[28, FEAD, 2002]

Combustion is an exothermic (heat generating) process. The majority of the energy produced during combustion is transferred to the flue-gases. Cooling of the flue-gas allows:

- the recovery of the energy from the hot flue-gases and
- cleaning of flue-gases before they are released to the atmosphere.

In plants without heat recovery, the gases are normally cooled by the injection of water, air, or both. In the majority of cases a boiler is used.

In waste incineration plants, the boiler has two interconnected functions:

- to cool the flue-gases
- to transfer the heat from the flue-gases to another fluid, usually water which, most often, is transformed inside the boiler into steam.

The characteristics of the steam (pressure and temperature) or of the hot water are determined by the local energy requirements and operational limitations.

The design of the boiler will mainly depend on:

- the steam characteristics
- the flue-gas characteristics (corrosion, erosion and fouling potentials).

The flue-gas characteristics are themselves highly dependent upon the waste content. Hazardous wastes for example, tend to have very wide variations in composition and, at times, very high concentrations of corrosive substances (e.g. chlorides) in the raw gas. This has a significant impact on the possible energy recovery techniques that may be employed. In particular, the boiler can suffer significant corrosion, and steam pressures may need to be reduced with such wastes.

Similarly the thermal cycle (steam-water cycle) will depend on the objective, for example:

- the highest electrical outputs require the most sophisticated cycles, but
- simpler cycles suit other situations e.g. supply of heat.

*Water walls* (the walls of the combustion chamber are made of water filled heat exchange pipes - usually with a protective coating of some type) are widely used to cool the combustion gases in the empty (i.e. of heat-exchange bundles) boiler passes. The first pass generally needs to be empty as hot gases are too corrosive and particulate matter is too sticky for the effective use of heat exchange tubes in this area.

Depending on the nature of the waste incinerated and the combustor design, sufficient heat may be generated to make the combustion process self supporting (i.e. external fuels will not be required).

The principal uses of the energy transferred to the boiler are:

- production and supply of heat (as steam or hot water)
- production and supply of electricity
- combinations of the above.

The energy transferred may be used on-site (thus replacing imported energy) and/or off-site. The energy supplied may be used for a wide variety of other processes. Commonly heat and steam are used for industrial or district heating systems, industrial process heat and steam and occasionally as the driving force for cooling and air conditioning systems. Electricity is often supplied to national distribution grids and/or used within the installation.

## 2.4.2 External factors affecting energy efficiency

### 2.4.2.1 Waste type and nature

The characteristics of the waste delivered to the installation will determine the techniques that are appropriate and the degree to which energy can be effectively recovered. Both chemical and physical characteristics are considered when selecting processes.

The chemical and physical characteristics of the waste actually arriving at plants or fed to the incinerator can be influenced by many local factors including:

- contracts with waste suppliers (e.g. industrial waste added to MSW)
- on-site or off-site waste treatments or collection/separation regimes
- market factors that divert certain streams to or from other forms of waste treatment.

In some cases the operator will have very limited scope to influence the characteristics of the waste supplied, in other cases this is considerable.

The table below gives typical net calorific value ranges for some waste types:

Input type	Comments and examples	NCV in original substance (humidity included)	
		Range GJ/t	Average GJ/t
Mixed municipal solid waste (MSW)	Mixed household domestic wastes	6.3 - 10.5	9
Bulky waste	e.g. furniture etc delivered to MSWIs	10.5 - 16.8	13
Waste similar to MSW	Waste of a similar nature to household waste but arising from shops, offices etc.	7.6 - 12.6	11
Residual MSW after recycling operations	Screened out fractions from composting and materials recovery processes	6.3 - 11.5	10
Commercial waste	Separately collected fractions from shops and offices etc	10 - 15	12.5
Packaging waste	Separately collected packaging	17 - 25	20
RDF-refuse derived fuels	Pellet or floc material produced from municipal and similar non-hazardous waste	11 - 26	18
Product specific industrial waste	e.g. plastic or paper industry residues	18 - 23	20
Hazardous waste	Also called chemical or special wastes	0.5 - 20	9.75
Sewage sludges	Arising from waste water treatment works	See below	See below
	Raw (dewatered to 25 % dry solids)	1.7 - 2.5	2.1
	Digested (dewatered to 25 % dry solids)	0.5 - 1.2	0.8

**Table 2.10: Ranges and typical net calorific values for some incinerator input wastes**  
Source (Energy sub-group 2003)

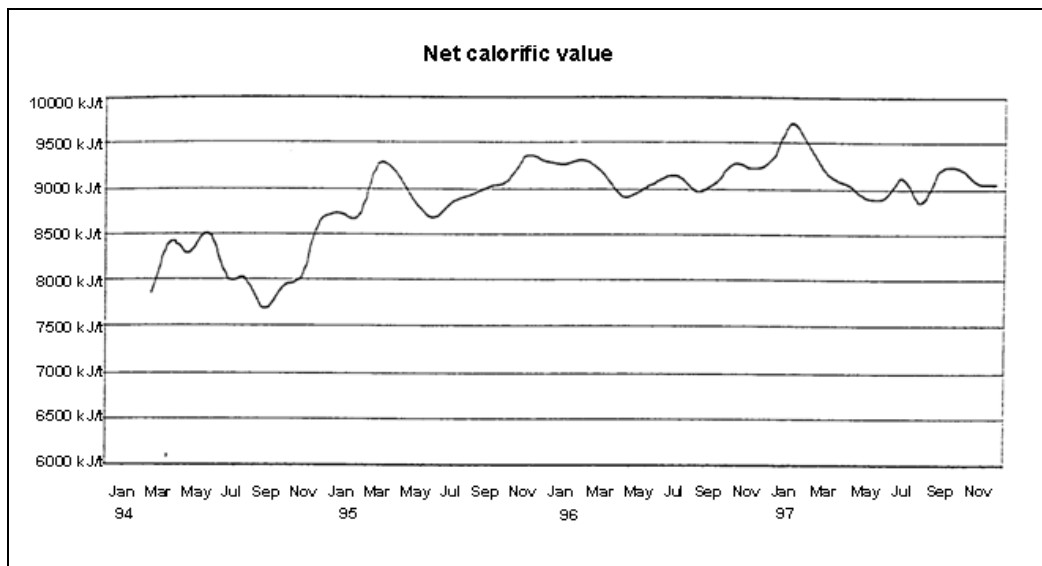

Figure 2.35: Graph showing recorded variation in waste NCV at a MSWI over 4 years

### Waste net calorific value calculation:

When considering the efficiency of any combustion process it is important take into account the energy flows of the system. With waste incinerators it can be difficult to properly assess efficiencies owing to uncertainties concerning the calorific value of the main energetic input i.e. the waste.

There are several calculation methods for the calorific value. Using the example calculation method outlined below, the following NCV results were obtained for 50 (mainly German) investigated MSW plants (2001 data):

NCV units	Minimum	Average	Maximum
MJ/kg	8	10.4	12.6
MWh/tonne	2.2	2.9	3.5

Table 2.11: Calculated NCV values for waste treated at 50 European MSWI plants  
Source [Energy subgroup, 2002 #29]

### Example of a calculation method:

A method allowing a very simple but reliable calculation (+/-5 %) of the NCV of the waste is shown in the following equation. The losses of heat etc. are taken into account. The data required for the calculation are generally available at incineration plants and are either measured or calculated from dimensioning figures such as steam parameters.

$$\text{NCV} = (1.133 \times (m_{\text{st w}}/m) \times c_{\text{st x}} + 0.008 \times T_b) / 1.085 \text{ (GJ/tonne)}$$

$$\text{NCV} = \text{lower calorific value (NCV) of the incinerated waste with } m_{\text{st w}}/m \geq 1 \text{ (GJ/tonne)}$$

$$\text{where, } m_{\text{st w}} = m_{\text{st x}} - (m_f \times (c_f / c_{\text{st x}}) \times \eta_b)$$

$m_{\text{st w}}$  = amount of the steam produced from the waste in the same time period to  $m_{\text{st}}$  e.g. per year (tonne/yr)

$m_{\text{st x}}$  = total amount of steam produced in a defined time period e.g. per year (tonne/yr)

$m_x$  = amount of supplementary fuel used in the corresponding time period e.g. per year (tonne/yr)

$m$  = mass of waste incinerated in the defined time period e.g. per year (tonne/yr)

- $c_{st x}$  = net enthalpy of steam i.e. enthalpy of steam minus enthalpy of boiler water (GJ/tonne)  
 $c_f$  = net calorific value of the supplementary fuel that add to steam production (GJ/tonne)  
 $T_b$  = temperature of flue-gas after boiler at 4 – 12 % O<sub>2</sub> in flue-gas (°C)  
 0.008 = specific energy content in flue-gas (GJ/tonne x °C).  
 1.133 and 1.085 are constants derived from regression equations  
 $\eta_b$  = efficiency of heat exchange to the boiler (approx. 0.80)

Note: This NCV calculation is only applicable to existing plants and not for the purposes of dimensioning new plants. It should also be noted that the formula can be applied within an operating range of 4 – 12 % O<sub>2</sub>, when the original design point was 7 - 9 % O<sub>2</sub>. Plants designed with O<sub>2</sub> concentrations outside the range of 7 - 9 % would require the use of modified coefficients to maintain accuracy.

### 2.4.2.2 Influence of plant location on energy recovery

In addition to waste quality and technical aspects, the possible efficiency of a waste incineration process is influenced to a large extent by the output options for the energy produced. Processes with the option to supply electricity, steam or heat will be able to use more of the heat generated during the incineration for this purpose and will not be required to cool away the heat, which otherwise results in reductions in efficiency.

The highest waste energy utilisation efficiency can usually be obtained where the heat recovered from the incineration process can be supplied continuously as district heat, process steam etc., or in combination with electricity generation. However, the adoption of such systems is very dependent on plant location, in particular the availability of a reliable user for the supplied energy.

The generation of electricity alone (i.e. no heat supply) is common, and generally provides a means of recovering energy from the waste that is less dependent on local circumstances. The table below gives approximate ranges for the *potential* efficiencies at incineration plants in a variety of situations. The actual figures at an individual plant will be very site-specific. The idea of the table is therefore to provide a means to compare what might be achievable in favourable circumstances. Doubts of calculation methods also make figures hard to compare – in this case the figures do not account for boiler efficiencies (typical losses ~ 20 %), which explains why figure approaching 100 % (figures exceeding 100 % are also quoted in some cases) are seen in some circumstances:

Plant type	Reported potential thermal efficiency % ((heat + electricity)/energy output from the boiler)
Electricity generation only	17 - 30
Combined heat and power plants (CHP)	70 - 85
Heating stations with sales of steam and/or hot water	80 - 90
Steam sales to large chemical plants	90 - 100
CHP and heating plants with condensation of humidity in flue-gas	85 - 95
CHP and heating plants with condensation and heat pumps	90 - 100
Note: The figures quoted in this table are derived from simple addition of the MWh of heat and MWh electricity produced, divided by the energy output from the boiler. No detailed account is taken of other important factors such as: process energy demand (support fuels, electrical inputs); relative CO <sub>2</sub> value of electricity and heat supply (i.e. generation displaced).	

**Table 2.12: Energy potential conversion efficiencies for different types of waste incineration plants**  
Source [RVF, 2002 #5]



The potential efficiencies are dependent on self-consumption of heat and electricity. Without taking the self-consumption into account, the calculated efficiencies of some facilities can lead to figures quoted of over 100 %. Distortions of efficiency figures are also common when boiler heat exchange losses are discounted (i.e. a boiler efficiency of 80 % means that 20 % of the flue-gas heat is not transferred to the steam, sometimes efficiency is quoted in relation to the heat transferred to the steam rather than the heat in the waste).

Where there is no external demand for the energy, a proportion is often used on-site to supply the incineration process itself and thus to reduce the quantity of imported energy to very low levels. For municipal plants, such internal use may be in the order of 10 % of the energy of the waste incinerated.

Cooling systems are employed to condense boiler water for return to the boiler.

Processes that are conveniently located for connection to energy distribution networks (or individual synergistic energy users) increase the possibility that the incineration plant will achieve higher overall efficiencies.

### 2.4.2.3 Factors taken into account when selecting the design of the energy cycle

The following factors are reported to be taken into account when determining the local design of a new waste incineration plant [51, CNIM, 2003]:

Factor to consider	Detailed aspects to consider
Waste feed	<ul style="list-style-type: none"> <li>Quantity and Quality</li> <li>Availability, Regularity, Delivery variation with seasons</li> <li>Prospect of change in both the nature and the quantity of waste</li> <li>Effects of waste separation and recycling.</li> </ul>
Energy sales possibilities	<p><b>Heat</b></p> <ul style="list-style-type: none"> <li>To communities e.g. district heating</li> <li>To private industries</li> <li>Heat use e.g. process use, heating use</li> <li>Geographical constraints; delivery piping feasibility</li> <li>Duration of the demand, duration of the supply contract</li> <li>Obligations on the availability of the supply i.e. is there another source of heat when the incinerator is shut down?</li> <li>Steam/Hot water conditions: pressure (normal/minimum), temperature, flowrate, condensate return or not?</li> <li>Season demand curve</li> <li>Subsidies can influence economics significantly</li> <li>Heat customer holdings in the plant financing i.e. security of supply contract.</li> </ul> <p><b>Electricity</b></p> <ul style="list-style-type: none"> <li>National grid or industrial network (rare), plant self consumption, customer self consumption (i.e. in a sewage sludge treating plant)</li> <li>Price of electricity significantly influences investment</li> <li>Subsidies or loans at reduced rates can increase investment</li> <li>Technical requirements: voltage, power, availability of distribution network connection.</li> </ul>
Local conditions	<ul style="list-style-type: none"> <li>Cooling medium selected: air or water</li> <li>Meteorological conditions in time: temperature, hygrometry, (min, average, max, curves)</li> <li>Acceptability of a "plume" of water vapour (cooling tower)</li> <li>Availability of cold water source: river or sea <ul style="list-style-type: none"> <li>- Temperature, quality of water</li> <li>- Flowrate which can be pumped according to the season</li> <li>- Permitted temperature increase.</li> </ul> </li> </ul>
Combined heat and power	<ul style="list-style-type: none"> <li>Apportionment according to the season</li> <li>Evolution of the apportionment in future.</li> </ul>
Other	<ul style="list-style-type: none"> <li>Choice between: Increasing energy output, reducing investment cost, operational complexity, availability requirements, etc.</li> <li>Acceptable noise level (air coolers)</li> <li>Available space</li> <li>Architectural Constraints.</li> </ul>

**Table 2.13: Factors taken into account when selecting the design of the energy cycle for waste incineration plants**  
Source [51, CNIM, 2003]

### 2.4.3 Energy efficiency of waste incinerators

[Energy subgroup, 2002 #29]

In order to enable a comparison of energy performance between waste incinerators, it is necessary to ensure that these comparisons are made in a consistent way. In particular it is necessary to standardise:

- assessment boundaries i.e. what parts of the process are included/excluded?
- calculation methods
- how to deal with different energy inputs and outputs e.g. heat, steam, electricity, primary fuels, re-circulation of energy produced by the plant, etc.

The sections that follow describe the typical inputs and outputs seen at many waste incinerators.

See also appendix 10.4 for information regarding energy efficiency calculation.

#### 2.4.3.1 Energy inputs to waste incinerators

[Energy subgroup, 2002 #29]

In addition to the energy in the waste, there are other inputs to the incinerator that need to be recognised when considering energy efficiency of the plant as a whole.

##### Electricity inputs:

Electrical consumption is usually easily calculated. In situations where economic incentives are provided to support the production of electrical energy from incineration (e.g. as a renewable source) there may be a price differential between purchased and exported electricity. Plants may then choose (for economic reasons) to export all of the electricity generated by the incinerator, and import from the grid, that which is required to run the incineration process itself. Where this is the case, the incineration plant will often have distinct electricity flows for input and output.

##### Steam/heat/hot water inputs:

Steam (heat or hot water) can be used in the process. The source can be external or circulated.

##### Fuels:

They are required for several uses. For instance, conventional fuels are consumed in order to:

- i. ensure that the required combustion chamber temperatures are maintained (this then contributes to steam production)
- ii. increase the temperature in the combustion chamber to the required level before the plant is fed with waste (this contributes partially to steam production)
- iii. increase the flue-gas temperature (e.g. after wet scrubbers) in order to avoid bag house filter and stack corrosion, and to suppress plume visibility
- iv. preheat the combustion air
- v. heat-up the flue-gas for treatment in specific devices, such as SCR or fabric filters.

When considering the overall efficiency of recovery of energy from the waste, it is important to note that some of these primary fuel uses can contribute to steam production and others will not. A failure to consider this may result in misleading efficiency figures due to the incorrect attribution of energy derived from the burning of primary fuels. For example:

- fuels used in auxiliary burners for i (fully) and ii (partially), will contribute to steam production (typically around 50 – 70 % of the additional fuel usage), whereas
- fuels used for items ii (the remaining 30 – 50 % auxiliary fuel use), iii and v above will not contribute to steam production.

Fuel (e.g. coal/coke) inputs (in addition to the waste) can also be made at gasification plants in order to produce a syngas with a desired chemical composition and calorific value.

### 2.4.3.2 Energy outputs from waste incinerators

#### Electricity:

The electricity production is easily calculated. The incineration process itself may use some of the produced electricity.

#### Fuels:

Fuel (e.g. syngas) is produced in gasification/pyrolysis plants and may be exported or combusted on site with (usually) or without energy recovery.

#### Steam/hot water:

The heat released in the combustion of waste is often recovered for a beneficial purpose, e.g. to provide steam or hot water for industrial or domestic users, for external electricity generation or even as a driving force for cooling systems.

Combined heat and power (CHP) plants provide both heat and electricity. Steam/hot water not used by the incineration plant can be exported.

## 2.4.4 Applied techniques for improving energy recovery

### 2.4.4.1 Waste feed pretreatment

There are two main categories of pretreatment techniques of relevance to energy recovery:

- homogenisation
- extraction/separation.

**Homogenisation** of waste feedstock mixes the wastes received at the plant using the physical techniques (e.g. bunker mixing and sometimes shredding) outlined elsewhere in this document, in order to supply a feed with consistent combustion qualities.

The main benefits achieved are the improved process stability that results, which thus allows smooth downstream process operation. Steadier steam parameters result from the boiler, which can allow for increased electricity generation. The overall energy efficiency benefits are thought to be limited but cost savings and other operational benefits may arise.

**Extraction/separation** involves the removal of certain fractions from the waste before it is sent to the combustion chamber.

Techniques range from extensive physical processes for the production of refuse derived fuels (RDF) and the blending of liquid wastes to meet specific quality criteria, to the simple spotting and removal by crane operators of large items that are not suitable for combustion, such as concrete blocks or large metal objects.

The main benefits achieved are:

- increased homogeneity, particularly where more elaborate pretreatment are used (see comments above for homogeneity benefits)
- removal of bulky items – thus the risks of obstruction and thus of non scheduled shut-downs
- possible use of fluidised beds or other techniques that could improve combustion efficiency.

Extraction, separation and homogenisation of the waste can significantly improve the energy efficiency of the incineration plant itself. This is because these processes can significantly change the nature of the waste that is finally delivered to the incineration process, which can then allow the incineration process to be designed around a narrower input specification, and lead to optimised (but less flexible) performance. However, for a wider assessment (beyond the scope of this document) it is important to note that the techniques that are used in the preparation of this different fuel, themselves require energy and will result in additional emissions.

(Note: The scope of this BREF does not extend to recommending the upstream systems that can influence the combustion characteristics and energy content of the waste received. It does however recognise that these upstream issues have a key influence on the characteristics of the waste finally received at the plant and hence what is achievable.)

#### 2.4.4.2 Boilers and heat transfer

Tubular water boilers are generally used for steam and hot water generation from the energy potential of hot flue-gases. The steam or hot water is generally produced in tube bundles in the flue-gas path. The envelopment of the furnace, the following empty passes and the space where evaporator and superheater tube bundles are located are generally designed with water cooled membrane walls.

In steam generation, it is usually possible to differentiate between the three heat surface areas, shown in Figure 2.36:

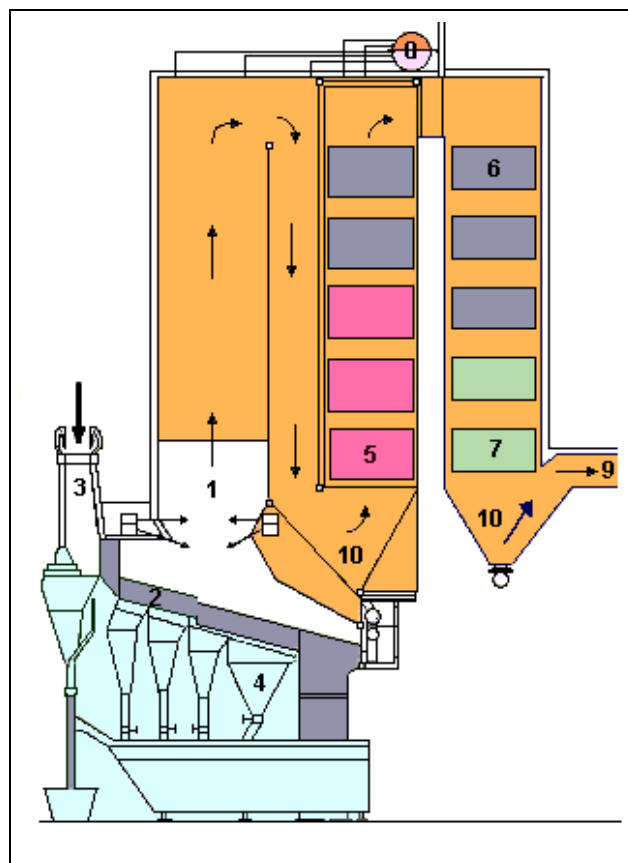

Figure 2.36: Illustration of individual heat surface areas in a steam generator  
Source [1, UBA, 2001]

Key to some of the features shown in Figure 2.36 (above):

**7 Feed-water preheating (Economiser):**

In this area, the boiler feed-water is heated by flue-gases to a temperature close to the boiling point (designed as a bundled heating surface).

**6 Evaporation:**

In this area, the water coming from the economiser is heated until it reaches the saturated steam temperature (designed as a bundled heating surface, envelopment wall of the incineration chamber).

**5 Superheating:**

In this area, the saturated steam coming from the evaporator is superheated to the end temperature (as a rule, bundled heating surfaces or bulkhead heating surfaces).

The following traditional evaporation systems can be differentiated (see Figure 2.37):

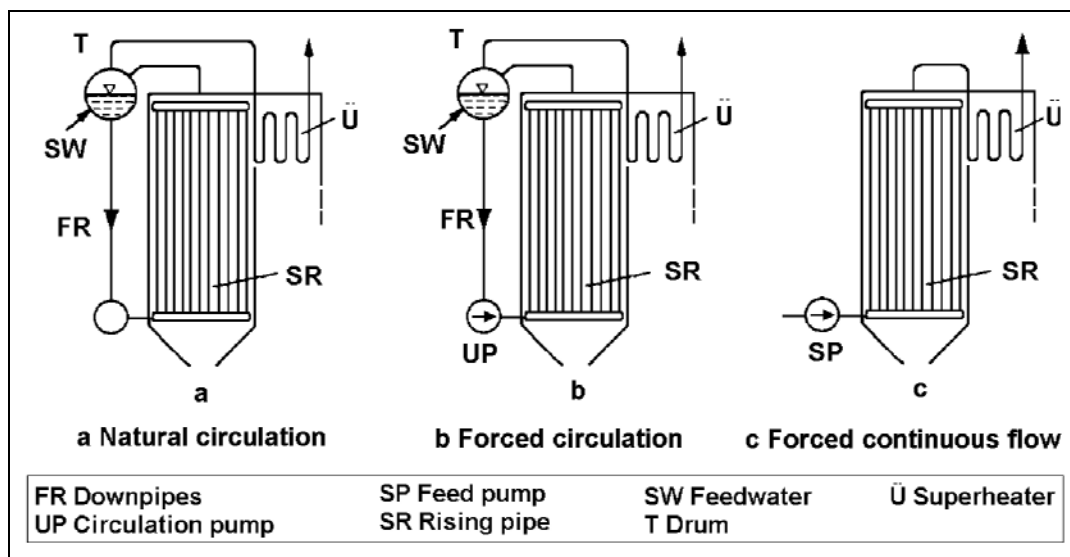

Figure 2.37: Basic boiler flow systems  
Source [1, UBA, 2001]

- **natural circulation:** The water/steam mass flow in the evaporator is maintained due to the different density of the medium in heated and unheated pipes. The water/steam mixture flows into a drum. Here, steam and water are separated. The saturated steam then reaches the post-connected superheater
- **forced circulation:** This principle corresponds with the natural circulation, but is expanded by a circulation pump supporting the circulation in the evaporator
- **forced continuous flow (once through boiler):** In this system, the feed-water is pressed in a continuous flow through the economiser, the evaporator, and the superheater.

Spray coolers and surface coolers are used in circulation boilers in order to maintain the exact required steam temperature. It is their function to balance the fluctuations of the steam temperature, these fluctuations being the consequences of load fluctuations, changes in the waste quality, the surplus air, as well as contamination of the heat surfaces.

The preparation of boiler feed water and make up water is essential for a effective operation and to reduce corrosion (inside the tubes) or risk of turbine damage. The quality of boiler water must be higher when increased steam parameters are used.

A compromise is required when determining steam parameters from waste fired boilers. This is because, while the selection of high temperatures and pressures better utilise the energy contained in the waste, these higher steam parameters can lead to significantly increased corrosion problems, especially at the superheater surfaces and the evaporator. In municipal waste incinerators it is common to use 40 bar and 400 °C, when there is electricity production although higher values are used, especially with pretreated MSW and prepared RDF (value of 60 Bar and 520 °C are in use with special measures to prevent corrosion). In case of heat production, steam with lower conditions or superheated water may be produced. Based on these rather low (compared to most primary fuel power stations) steam parameters, almost exclusively, natural circulation steam boilers are selected.

A feature of waste incineration is the high dust load in flue-gases. Measures that can assist dust removal in the boiler areas by gravity separation of fly ash, are:

- low flue-gas speeds, and
- turns in the gas flow path.

The high proportion of ash in flue-gas causes a risk of a correspondingly high contamination of the heat transfer surfaces. This leads to a decline in heat transfer and therefore a performance loss. Thus, heat transfer surface cleaning plays an important role. This cleaning can be accomplished manually or automatically with lances (compressed air or water jet), with agitators, with soot blowers using steam, with a hail of pellets (sometimes shot cleaning), with sound and shock waves, or with tank cleaning devices.

Different boiler concepts can be used in waste incineration plants. They are from left to right (see Figure 2.38):

- horizontal boilers
- combination of vertical and horizontal boilers
- vertical boilers.

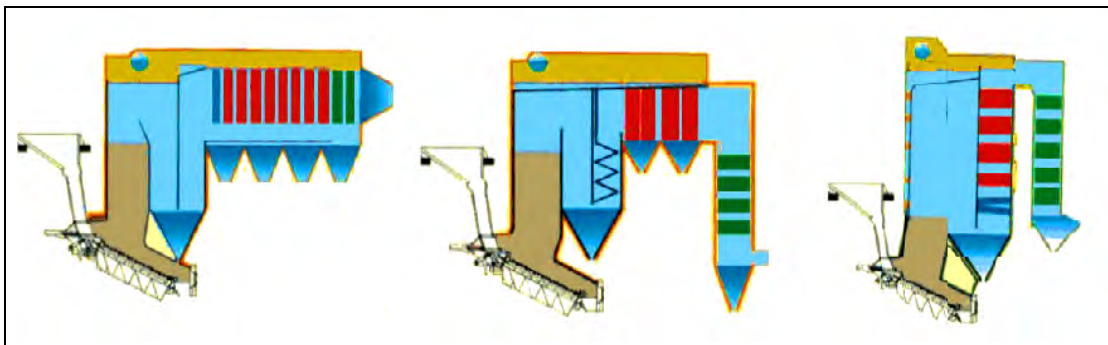

**Figure 2.38: Overview of various boiler systems: horizontal, combination, and, vertical**  
Source [1, UBA, 2001]

In horizontal and vertical systems usually a number of empty passes with evaporation walls are followed by an arrangement of bundles of heat transfer surfaces i.e. evaporator, superheater and economiser. The selection of the system to be deployed depends on the given building concept, the selected steam parameters, and the customer specifications.

#### 2.4.4.2.1 Corrosion in boilers

[1, UBA, 2001] With the introduction of minimum temperature residence times and oxygen content requirements, corrosion has increased in steam generators at waste incineration plants.

**Corrosion** is caused by the chemical attack of flue-gas and ash particles from the furnace. The incineration chamber, the water walls of the first blank (empty) passes, and the super heater are the boiler components that are most in danger of corrosion.

**Erosion**, which is the abrasion of surface material through vertical wear-and-tear, is caused primarily by the ash particles present in flue-gas. Erosion appears mostly in the area of gas redirection.

**Tube wear** is caused by a combination of corrosion and abrasion. Corrosion appears on clean metallic surfaces. If the corrosion products deposit themselves as film on the pipe surface (oxide layer), they function as a protective layer and slow down corrosion. If this protective layer wears out through erosion, and if the metallic surface reappears, the entire process starts anew.

Coherent consideration of the corrosion processes is difficult, as physical, chemical, incineration technical, metallurgical and crystallographic parameters interact.

Various types of flue-gas corrosion exist:

- Tinder process: High temperature corrosion
- Initial corrosion: Time-limited ferrous chloride formation before the first oxide layer formation at “blank” steel during start-up. This reaction occurs continuously after film removal through erosion
- Oxygen-deficiency corrosion: through  $\text{FeCl}_2$ -formation under deoxygenated flue-gas atmosphere, e.g. under films (such as oxides, contamination or fireproof material) and in the furnace area.  $\text{FeCl}_2$  is sufficiently volatile in the temperatures used in WI and is therefore mobilised. An indicator for such corrosion is the appearance of CO (this explains the often falsely used term CO corrosion). The microscopic situation at the border between material and film is, however, decisive. This corrosion is observed in individual cases with steam pressures above 30 bar, but more usually above 40 bar. Corrosion rate increases with metal temperature. The corrosion products appear in flaky layers
- Chloride-High temperature corrosion: Corrosion by chloride, which is released during the sulphating of alkaline chlorides, and attacks iron or lead hydroxides. This corrosion mechanism is observed in waste incineration plants with flue-gas temperatures  $>700\text{ }^\circ\text{C}$  and at pipe wall temperatures above  $400\text{ }^\circ\text{C}$ . The corrosion products can be recognised as a black firmly bonded cup that includes a hygroscopic red  $\text{FeCl}_3$  layer in thicker films
- Molten salt corrosion: The flue-gas contains alkali and similar components, which can form eutectics. Eutectic compounds have a lower melting point than the single components which form the eutectic system. These molten systems are highly reactive and can cause severe corrosion of steel. They can react with the refractory lining and lead to the internal formation of compounds like kalsilite, leucite, sanidine which destroy the refractory mechanically. It can also form low viscous melts on the surface consisting of deposited material and refractory material (refractory corrosion).  
[64, TWGComments, 2003] [74, TWGComments, 2004]
- Electrochemical Corrosion: This is based on the electrical potential equalisation of different metals. The conductor can be aqueous or a solid that shows sufficient electrical conductivity at the temperatures seen. The conductivity can arise from the water dew point to the sulphuric acid dew point to molten salt
- Standstill corrosion: Based on its high chloride content (especially  $\text{CaCl}_2$ ), the deposits are hygroscopic. The humidity in the air dissolves these compounds and causes chemical dissolution appearances in the material



- **Dew point corrosion:** When the temperature falls beneath the acid dew point, wet chemical corrosions appear on cold surfaces. This damage can be avoided by raising the temperature or by selecting an appropriate material.

In reality, from a thermodynamic perspective, a degree of corrosion is unavoidable. Counter measures only help to reduce corrosion damage to an acceptable level. The causes of corrosion require constructive and operational counter-measures. Improvement possibilities are mainly found in the steam generator. Low steam parameters, long reaction times before entry into the heat surfaces, lowering the flue-gas speed, and levelling of the speed profile could all be successful. Protective shells, tooling, stamping, and deflectors can also be used to safeguard heat surfaces.

A compromise must be found in determining the boiler cleaning intensity between the best possible heat transfer (metallic pipe surface) and optimal corrosion protection.

#### **2.4.4.3 Combustion air preheating**

Preheating the combustion air is particularly beneficial for assisting the combustion of high moisture content wastes. The pre-warmed air supply dries the waste, thus facilitating its ignition. The supply heat can be taken from the combustion of the waste by means of heat-exchange systems.

Preheating of primary combustion air can have a positive influence on overall energy efficiency in case of electricity production.

#### **2.4.4.4 Water cooled grates**

Water cooling of grates is used to protect the grate. Water is used as a cooling medium to capture heat from the burning waste bed and use it elsewhere in the process. It is common that the heat removed is fed back into the process for preheating the combustion air (primary and/or secondary air) or heating the condensate. Another option is to directly integrate the water-cooling into the boiler circuit, operating it as an evaporator.

These grates are applied where the net calorific value of the waste is higher, typically above 10MJ/kg. At lower calorific values their application is more limited. Increases in the calorific value of municipal waste seen in Europe have increased the application of this technique.

There are other reasons for the use of water-cooled grates – these are discussed in section 2.3.1.2.5.

#### **2.4.4.5 Flue-gas condensation**

[5, RVF, 2002]

Water in the flue-gas from combustion comprises evaporated free water from the fuel and reaction water from the oxidation of hydrogen, as well as water vapour in the combustion air. When burning wastes, the water content in the flue-gas after the boiler and economiser normally varies between 10 and 20 % by volume, corresponding to water dew points of about 50 – 60 °C. During cleaning of the boiler with steam the water content in the flue-gas increases to about 25 %.

The minimum possible dry gas temperature at this point is 130 - 140 °C using normal boiler construction material. This temperature is mostly determined in order to be above the acid dew point, linked to the SO<sub>3</sub> content and the H<sub>2</sub>O content in the flue-gas.

Lower temperatures result in corrosion. The boiler thermal efficiency (steam or hot water from waste) will, under these conditions, be about 85 %, as calculated based on the calorific value of the waste input. However, if there is more available energy in the flue-gas, a water vapour will result which has a latent specific energy of about 2500 kJ/kg and dry gas with a specific heat of about 1 kJ/(kg °C).

Return water from district heating at a temperature of 40 - 70 °C (system configuration dependent), can be used directly to cool and condense the water vapour in the flue-gas. This system is common at plants burning bio-fuel, which normally is very wet and gives water dew points of 60 - 70 °C in the flue-gas.

### **Example: Stockholm/Hogdalen (Sweden):**

At the Stockholm/Hogdalen (Sweden) plant this system is used with three conventional grate fired steam boilers and one with a circulating fluidised bed. Flue-gases from the conventional grate fired boilers are cooled in shot cleaned waste heat boilers to about 140 °C. Return water from district heating is used as the cooling media.

FGT starts with a dry cleaning system for each boiler in which dry hydrated lime is injected and mixed with the flue-gas in a reactor. The acid impurities react with the lime and solid salts are formed which are removed in a fabric filter together with fly ash and the excess of lime. The final reaction takes place in the dust cake on the bags. The fluidised bed boiler has a slightly different reactor as re-circulated dust from the fabric filter is slightly humidified before it is mixed with fresh lime and injected into the flue-gases.

The second cleaning stage includes wet scrubbers, which saturate the flue-gas and remove the rest of the acid gases, particularly hydrogen chloride (HCl) and sulphur dioxide (SO<sub>2</sub>). The saturated gas leaving the wet scrubbers has a temperature of about 60 °C. It is sucked to a tube condenser, which is cooled by return water from the district heating at a temperature of 40 - 50 °C. One wet system is used for all three grate boilers, although the CFB-boiler has its own.

If the return water temperature is 40 °C (the normal case for this plant but very low in comparison with the majority of European climates) 14 % additional energy is recovered in the condenser. On the other hand, if the return water temperature is 50 °C only about 7 % additional energy is recovered. For extreme cases, when the return water temperature is as high as 60 °C, no extra heat is recovered.

In the Stockholm/Hogdalen case the flue-gas is reheated before the ID fan and stack and for this reheating some MW of low-pressure steam is consumed. It is also possible to operate without this reheat but with a wet fan and stack.

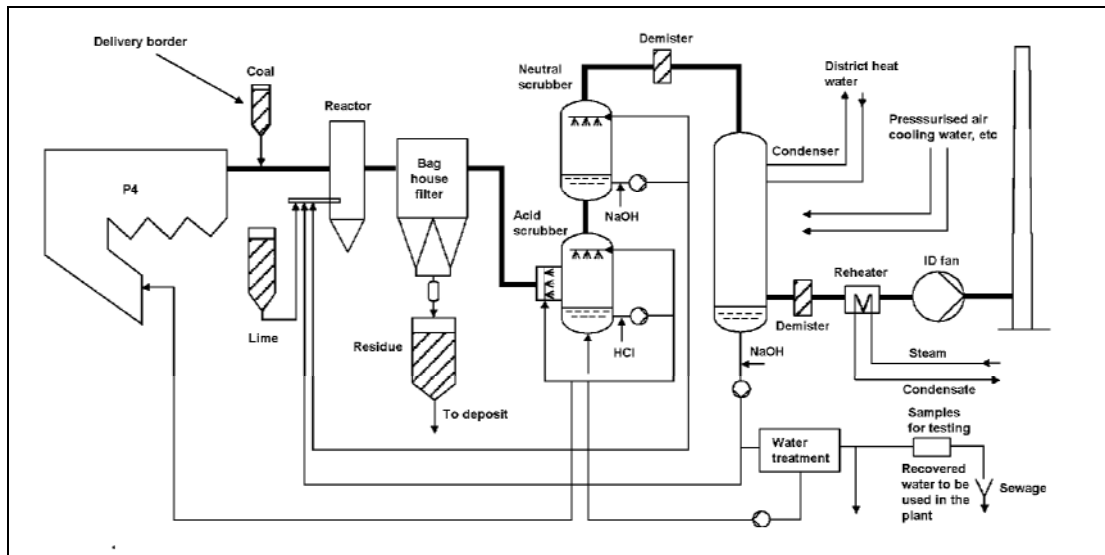

**Figure 2.39: Pollution control and additional heat recovery by condensation of flue-gas water vapour at the Stockholm/Hogdalen waste-fired CHP plant**  
Source [RVF, 2002 #5]

This simplified example shows that condensation can be effective only if there is a comparatively big temperature difference between the water dew point in the flue-gas and the cooling water (normally district heating return water). If this condition is not fulfilled heat pumps can be installed (see below).

It should be noted that, in this case, it is the cold district heating water return that provides the energetic driver for the condensation of the flue-gases. This situation is only likely to exist in regions with the lower ambient temperatures found mostly in Northern Europe.

#### 2.4.4.6 Heat pumps

[RVF, 2002 #5]

The main purpose of heat pumps is to transform energy from one temperature level to a higher level. There are three different types of heat pumps in operation at incineration installations. These are described below with examples.

##### 2.4.4.6.1 Compressor driven heat pumps

This is the most well known heat pump. It is, for instance, installed in refrigerators, air conditioners, chillers, dehumidifiers, and heat pumps used for heating with energy from rock, soil, water and air. An electrical motor normally drives the pump, but for big installations steam turbine driven compressors can be used.

In a closed-circuit, a refrigerant substance (e.g. R134a), is circulated through a condenser, expander, evaporator and compressor. The compressor compresses the substance, which condenses at a higher temperature and delivers the heat to the district heating water. There the substance is forced to expand to a low pressure, causing it to evaporate and absorb heat from the water from the flue-gas condenser at a lower temperature. Thus the energy at low temperature in the water from the flue-gas condenser has been transformed to the district heating system at a higher temperature level. At typical incineration conditions, the ratio between output heat and compressor power (heat to power ratio) can be as high as 5. The compressor driven heat pump can utilise very much of the energy from the flue-gas.

### 2.4.4.6.2 Absorption heat pumps

Similar to the compressor type pump, absorption heat pumps were originally developed for cooling. Commercial heat pumps operate with water in a closed loop through a generator, condenser, evaporator and absorber. Instead of compression the circulation is maintained by water absorption in a salt solution, normally lithium bromide, in the absorber. The diluted water/salt solution is pumped to the generator. There the water is evaporated by hot water or low-pressure steam and is then condensed in the condenser at a higher temperature. The heat is transferred to the district heat water. The concentrated salt solution is circulated back to the absorber. The process is controlled by the pressure in the system, in relation to the vapour pressure of the liquids, water and lithium bromide.

Electrical power consumption is very low, limited to a small pump between the absorber and generator, and there are few moving parts. The ratio between the output heat and absorber power is normally about 1.6.

### 2.4.4.6.3 Open heat pumps

The third heat pump is sometimes called open heat pump. The principle is to decrease the water content of the flue-gas downstream of the condenser using a heat and humidity exchanger with air as intermediate medium.

The higher water content in the flue-gas in the condenser means a higher water dew point, and a bigger difference between the water dew point and the dew point of the return water from the district heating system.

### 2.4.4.6.4 Example data of different heat pumps

The following table has been collated from data from three different plants in Sweden, each using a different type of heat pump, as described above.

As it can be seen from the table, the use of heat pumps consumes electricity; therefore the net electrical output is reduced. However, the thermal heat output is increased.

	<b>Example 1</b>	<b>Example 2</b>	<b>Example 3</b>
<b>Heat pump type</b>	<b>Compressor driven</b>	<b>Absorption heat pump</b>	<b>Open heat pumps</b>
Net heat output using heat pump	82	80	81
Net heat output <b>without</b> heat pump	60	63	70
<b>Variation in heat output</b>	<b>+37 %</b>	<b>+28 %</b>	<b>+16 %</b>
Net electricity output using heat pump	15	15	0
Net electricity output <b>without</b> heat pump	20	19	0
<b>Variation of electricity production</b>	<b>-25 %</b>	<b>-21 %</b>	<b>0</b>
Data refer to an energy input of 100, therefore all numbers are percentages. Example 3 does not produce electricity Source: Data have been collated from 3 examples of plants in Sweden.			

**Table 2.14: Example data showing the variation in heat and electricity output when using various different types of heat pumps**

Source [5, RVF, 2002]

#### 2.4.4.7 Flue-gas re-circulation

A proportion (approx. 10 – 20 % by volume) of the (usually cleaned) flue-gases is re-circulated, normally after pre-dedusting, to replace secondary air feeds in the combustion chamber.

This technique is reported to reduce heat losses with the flue-gas and to increase the process energy efficiency by around 0.75 % - 2 %. Additional benefits of primary NO<sub>x</sub> reduction are also reported.

Lagging of the re-circulation ducting is reported to provide an effective remedy for corrosion concerns in this area.

#### 2.4.4.8 Reheating of flue-gases to the operation temperature FGT devices

Some air pollution control equipment requires the flue-gases to be reheated to enable their effective operation. Examples include SCR systems and bag filters that generally require temperature in the region of 250° C and 120° C respectively.

The energy for heating the gases can be obtained from:

- external energy sources (e.g. electrical heating, gas or oil burners)
- use of process generated heat or power (e.g. steam bleeds from the turbine).

The use of heat-exchangers to recapture the heat after the equipment reduces the need for external energy input. This is carried out where the next stage of the process does not require the flue-gas temperature to be as high as that emitted from the earlier equipment.

#### 2.4.4.9 Plume visibility reduction

In some locations sensitivity to visible plumes is high. Certain techniques (e.g. wet scrubbing) also give rise to higher levels of moisture in the flue-gas and therefore increase the possibility of high visibility plumes. Lower ambient temperature and higher humidity levels increase the risk of plume condensation, and hence visibility.

Increasing the temperature of the flue-gases provides one way of reducing plume visibility, as well as improving dispersion characteristics of the release. Dependent on flue-gas moisture content and atmospheric conditions, plume visibility is greatly reduced above stack release temperatures of 140 °C.

Reducing the moisture content of the flue-gases also reduces the plume visibility. This can be achieved by selecting alternative flue-gas treatment (i.e. avoiding wet systems) or by the use of condensing scrubbers to remove water from the flue-gas (see Section 2.4.4.5).

#### 2.4.4.10 Steam-water cycle improvements: effect on efficiency and other aspects

The selection of the steam water cycle will generally have a much greater impact on energy efficiency of the installation than improving individual elements of the system, and therefore provides the greatest opportunity for increased use of the energy in the waste.

The following table provides example information concerning techniques of actions that are used for improving energy recovery at a municipal waste to energy incinerator, along with an estimation of their "weight". The figures given were calculated for one example plant that only generated electricity [50, CNIM, 2003]:

Technique	Net Power output increase (approx.) and other advantages	Disadvantages
Increase steam pressure	3 % for 60 bars instead of 40 bars	increase in investment cost corrosion risk slightly increased
Decrease vacuum at turbine outlet (e.g. a hydro-condenser may be used to improve vacuum)	1 to 2 % for 20 mbar reduction	significant increase in investment cost (air condenser area: + 10 % between 120 and 110 mbar at air temperature=15 °C) size and noise increase. uncertainties on suppliers commitments for very low pressure
Heating secondary air	0.7 % to 1.2 %	complexity and cost increase if there are 2 air fans
Air heater in 2 stages (i.e. 2 bleeds on the turbine)	1 to 1.5 %	cost increase space requirement increase
Increase deaerator temperature	0.9 % for 140 °C instead of 130 °C	increase the size and the cost of the economiser
Add a condensate heater	0.5 to 1.2 %	cost of the equipment and piping not necessarily applicable for small TG sets corrosion problem may occur in particular during transitory phases (start up, shut down etc.)
Recycle a part of the flue-gas	0.75 to 2 % for a decrease of 1 % of dry O <sub>2</sub> ----- Decrease NO <sub>x</sub> level by approx. 100 mg/Nm <sup>3</sup>	increase the investment cost decreasing the O <sub>2</sub> by other means reduces the interest of flue-gas recycling corrosion problem may occur in particular during transitory phases (start up, shut down etc.)
Reduce the flue-gas temperature at boiler outlet	0.4 to 0.7 % for 10 °C lower between 190 °C and 140 °C	the boiler outlet temperature is determined according to the FGT system type
Use SNCR de-NO <sub>x</sub> instead of SCR	3 to 6 % according to the processes used	see discussions about SCR and SNCR de-NO <sub>x</sub>
Optimise the choice of the TG set	1 to 2 % instantaneous But much higher difference over a long period of time if low availability	some TG sets have higher efficiency at nominal conditions but lower reliability, availability and/or flexibility at partial load
Reduction of O <sub>2</sub> -content in flue-gas of 1 % (in range 6 - 10 %)	1 – 2 % increase	with lower O <sub>2</sub> content, CO may increase low oxygen content may increase corrosion risk.

**Table 2.15: Steam-water cycle improvements: effect on efficiency and other aspects.**  
Source [50, CNIM, 2003]

### 2.4.5 Steam generators and quench cooling for hazardous waste incinerators

In Europe there are two main approaches adopted for cooling the combustion gases from hazardous waste incinerators. Their principle advantages and disadvantages are described in the table below:

Gas cooling system	Advantages	Disadvantages
Heat recovery boiler	<ul style="list-style-type: none"> <li>• high energy recovery efficiency possible (70 – 80 % can be converted to steam)</li> <li>• lower water consumption and water treatment volumes.</li> </ul>	<ul style="list-style-type: none"> <li>• possible increased risk of dioxin reformation in boiler</li> <li>• additional capital and maintenance costs of boiler system.</li> </ul>
Rapid quench cooling	<ul style="list-style-type: none"> <li>• reduced risk of dioxin re-formation</li> <li>• need for additional dioxin controls on emissions to air may be reduced</li> <li>• it may be possible to treat wastes with a more variable range and higher halogen or salts loading if this technique is used.</li> </ul>	<ul style="list-style-type: none"> <li>• very limited energy recovery</li> <li>• water consumption may be higher</li> <li>• water treatment volumes may be higher.</li> </ul>

**Table 2.16: Summary of the main differences between quench cooling and heat recovery**

Source adapted from [Cleanaway, 2002 #46], [EURITS, 2002 #41]

#### Heat recovery boilers in hazardous waste incineration installations:

[EURITS, 2002 #41]

The hot combustion gases are cooled in a **steam generator** (or **boiler**) with a capacity of between 16MW and 35MW depending on the installation. The steam that is produced has a pressure of 13 bar to 40 bar with a temperature between 207 and 385 °C. As a guideline, a fully-equipped installation normally produces an average of 4 – 5 tonnes of steam per tonne of incinerated waste, thereby attaining a thermal efficiency of 70 – 80 % (energy in steam versus energy in waste). Most installations are equipped with an **economiser device** and a **super-heater** if electricity is produced. A range of factors influence the efficiency of the steam generators used in hazardous waste incinerators, including the composition of the gas and the potential for deposition to occur on the heat-exchange surfaces. This has a significant influence on the construction materials used and on the design, as well as on the operational life and performance of the equipment.

For some installations, the steam is used in a **turbine** to produce electricity. The electricity is used by the incineration plant for its own purposes or exported. Alternatively steam may be transported for direct use in industrial processes, e.g. the production of chemicals, or to other waste treatment processes or fed into a district heating system. Combinations of these are also applied.

#### Rapid quench cooling:

Some installations are not equipped with a boiler, but the combustion gases are reduced in temperature by means of **very quick quench cooling** (e.g. 1100 °C to 100 °C in less than 1 second). This is performed to prevent the formation of dioxins and to avoid the installation of an extra end-of-pipe dioxin removal technique. These installations are referred to as '*quencher*s', and have been adopted in some plants where a very wide range of highly halogenated wastes inputs have to be treated. This limits the potential options for energy recovery.

### **2.4.6 Examples of energy recovery from fluidised bed incinerators**

The different designs and size of fluidised bed incinerators influence the behaviour of the boiler and the amount and type of energy produced [33, Finland, 2002]. The following two examples give approximate figures for different sizes of incinerators:

### **1. 15 - 30 MW heat and low pressure steam producing boilers:**

This size of fluidised bed boiler uses approx. 35000 - 40000 tonnes per year of ready made recovered fuel. If it is made of commercial waste, demolition waste and separately collected packages from households, it can use all of this kind of material generated by a city of about 150000 inhabitants. The heat produced is about 150 GWh, which could be used by industry or for district heating.

Boilers of this size are very similar to operate to normal power plant boilers of 50 - 100 MW. Its behaviour is steady and uniform, because of the ready made controlled fuel made of sorted waste, and the heavy bed.

When a suitable energy user is available an energy efficiency range of 70 - 90 % can be achieved.

Rotating fluidised bed incinerators have been designed for thermal capacities from 10 - 55 MW (thermal) and corresponding waste throughput of 22000 - 167000 tonnes/yr per line. Energy is recovered by steam generators and used for electricity production and/or heating purposes depending on local requirements. Thermal efficiency is can be about 80 %, and electrical efficiency typically around 25 %. [64, TWGComments, 2003]

### **2. 50 - 100 MW electricity producing power plants:**

If the size of the waste to energy boiler is >30 MW, it may be more difficult to find a suitable customer for such quantity of heat energy. Whenever electricity is also produced, the economics of the waste to energy boiler is mostly dependent on the price of the electricity, not on the price of the heat.

Electrical efficiency with well-defined, quality controlled feeds can be relatively high, up to level of 30 – 35 % with typical steam temperatures from 450 – 500 °C.

## **2.5 Applied flue-gas treatment and control systems**

### **2.5.1 Summary of the application of FGT techniques**

Flue-gas treatment systems are constructed from a combination of individual process units that together provide an overall treatment system for the flue-gases. A description of the individual process units, organised according to the substances upon which they have their primary effect, is given in this chapter.

Table 2.17 below gives a summary of the application of some systems in the municipal waste incineration sector. The balance of applied systems is different with different waste streams. A description of each of the techniques listed in the table is given later in this section:



Number of MSWI plants with various flue-gas treatment systems									
	Dry with FF	Semi-dry with FF	Wet	Dry and Wet	SD and Wet	Electrostatic precipitator only	Fabric filter only	SNCR de-NO <sub>x</sub>	SCR de-NO <sub>x</sub>
<b>Austria</b>			2					applied	applied
<b>Belgium</b>	2	9	8		1			applied	applied
<b>Denmark</b>	7	17	6			1	1	applied	
<b>France</b>	13	25	45			19		applied	
<b>Germany</b>	5	16	30	2	5		1	17	42
<b>Great Britain</b>	1	9						applied	
<b>Hungary</b>						1			
<b>Italy</b>	26	6	3	8	4				
<b>Netherlands</b>		1	5		4			3	applied
<b>Norway</b>	4	1	3						
<b>Portugal</b>		3						3	
<b>Spain</b>	1	7							
<b>Sweden</b>	5	1	7	2			2	applied	applied
<b>Switzerland</b>		1	29						applied
<b>Total plants</b>	<b>64</b>	<b>95</b>	<b>138</b>	<b>12</b>	<b>14</b>	<b>21</b>	<b>4</b>	<b>23</b>	<b>43 (of 200)<sup>3</sup></b>
Notes:									
1. All figures (except SCR data) are derived from data provided to TWG in [42, ISWA, 2002] - Tables 1 and 2 and TWG Comments									
2. Other combinations of FGT unit operations are applied but not included in the table									
3. Data supplied to EIPPCB by FEAD suggests 43 of around 200 surveyed MSWI use SCR									
4. Belgium data only represents Flemish region and Brussels only									
5. <i>applied</i> indicates that the technique is applied – data for blanks was not provided									

**Table 2.17: Summary of the main applied FGT systems for MSWIs in Europe in 2000/2001**

Source adapted from [42, ISWA, 2002, 64, TWGComments, 2003]

Some flue-gas treatment techniques are also explained in detail in the horizontal BREF “Reference Document on Best Available Techniques in the Waste Water and Waste Gas Treatment/Management Systems in the Chemical Sector (CWW)”.

## 2.5.2 Overview of overall combined FGT system options

The individual components of a FGT system are combined to provide an effective overall system for the treatment of the pollutants that are found in the flue-gases. There are many individual components and designs, and they may be combined in many ways. The diagram below shows an example of the options and their possible combination. It can be seen that in this assessment there are a total of 408 different combined systems:

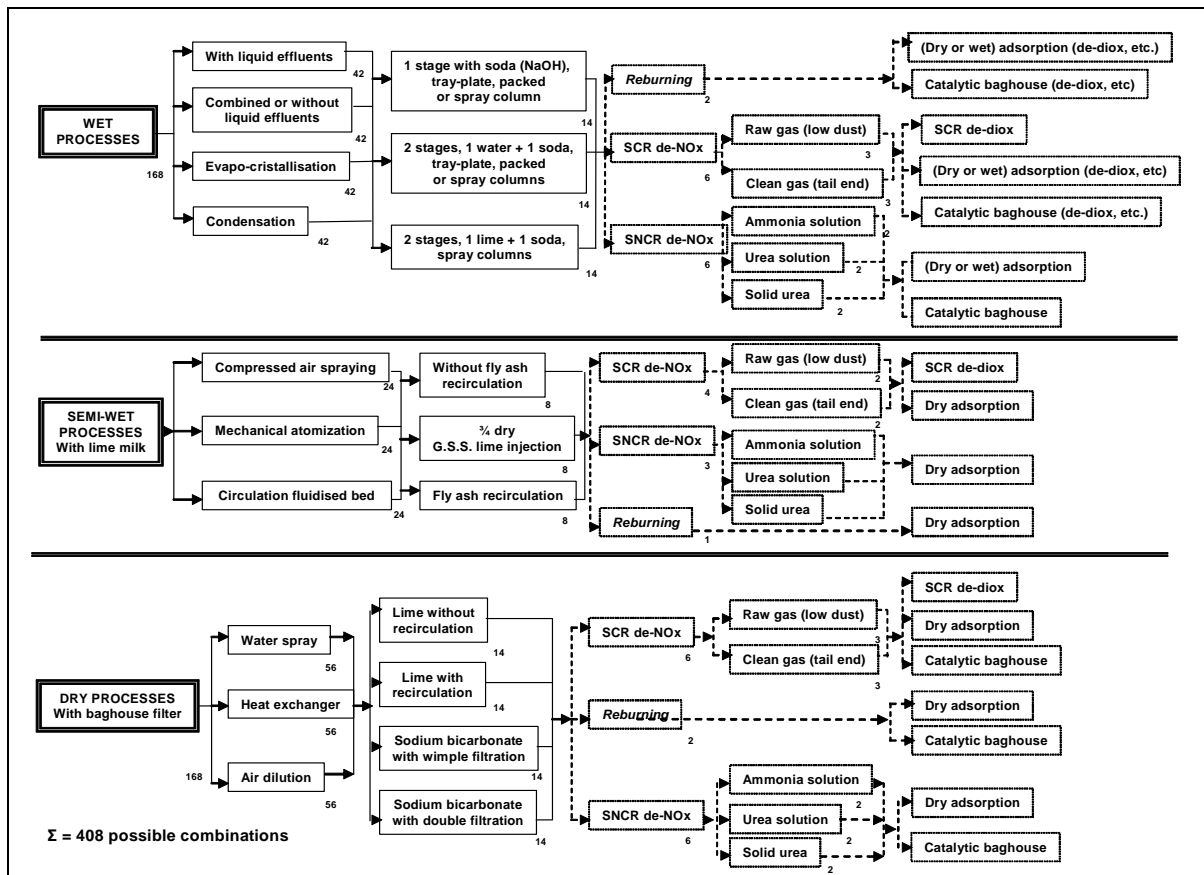

Figure 2.40: Overview of potential combinations of FGT systems

## 2.5.3 Techniques for reducing particulate emissions

[1, UBA, 2001] The selection of gas cleaning equipment for particulates from the flue-gas is mainly determined by:

- particle load in the gas stream
- the average particle size
- particle size distribution
- flowrate of gas
- flue-gas temperature
- compatibility with other components of the entire FGT system (i.e. overall optimisation)
- required outlet concentrations.

Some parameters are rarely known (such as particle size distribution or average size) and are empirical figures. Available treatment or disposal options for the deposited substances may also influence FGT system selection i.e. if an outlet exists for treatment and use of fly ash, this may be separately collected rather than the fly ash collected with FGT residues.  
[74, TWGComments, 2004]

### 2.5.3.1 Electrostatic precipitators

[1, UBA, 2001]

Electrostatic precipitators are sometimes also called electrostatic filters. The efficiency of dust removal of electrostatic precipitators is mostly influenced by the electrical resistivity of the dust. If the dust layer resistivity rises to values above approx.  $10^{11}$  to  $10^{12}$   $\Omega\text{cm}$  removal efficiencies are reduced. The dust layer resistivity is influenced by waste composition. It may thus change rapidly with a changing waste composition, particularly in hazardous waste incineration. Sulphur in the waste (and water content at operational temperatures below 200 °C [64, TWGComments, 2003]) often reduces the dust layer resistivity as  $\text{SO}_2$  ( $\text{SO}_3$ ) in the flue-gas and, therefore facilitates deposition in the electric field.

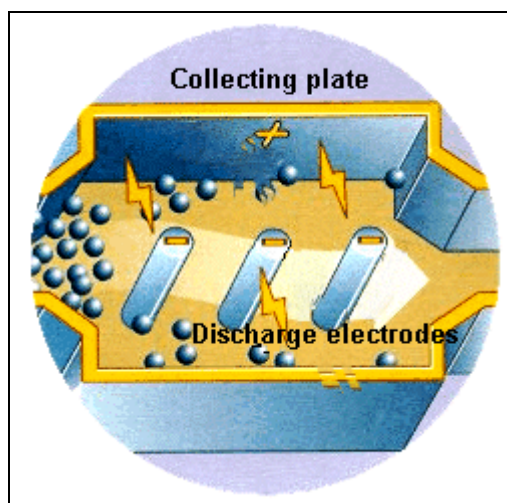

**Figure 2.41: Operating principle of an electrostatic precipitator**  
Source [1, UBA, 2001]

For the deposition of fine dust and aerosols, installations that maintain the effect of the electric field by drop formation in the flue-gas (pre-installed condensation and wet electrostatic precipitators, condensation electrostatic precipitators, electro-dynamic venture scrubbers, ionised spray coolers) can improve removal efficiency.

Typical operational temperatures for electrostatic precipitators are 160 - 260 °C. Operation at higher temperatures (e.g. above 250 °C) are generally avoided as this may increase the risk of PCDD/F formation (and hence releases).

### 2.5.3.2 Wet electrostatic precipitators

[1, UBA, 2001] Wet electrostatic precipitators are based upon the same technological working principle as electrostatic precipitators. With this design, however, the precipitated dust on the collector plates is washed off using a liquid, usually water. This may be done continuously or periodically. This technique operates satisfactorily in cases where moist or cooler flue-gas enters the electrostatic precipitator.

### 2.5.3.3 Condensation electrostatic precipitators

[1, UBA, 2001]The condensation electrostatic precipitator is used to deposit very fine, solid, liquid or sticky particles, for example, in the flue-gas from hazardous waste incineration plants. Unlike conventional wet electrostatic precipitators, the collecting surfaces of condensation electrostatic precipitators consist of vertical plastic tubes arranged in bundles, which are externally water-cooled.

The dust-containing flue-gas is first cooled down to dew-point temperature in a quench by direct injection of water and then saturated with vapour. By cooling the gases in the collecting pipes further down, a thin, smooth liquid layer forms on the inner surface of the tubes as a result of condensation of the vapour. This is electrically earthed and thus serves as the passive electrode.

Particles are deposited by the influence of the electric field between the discharge electrodes suspended in the tube axes and the condensation layer in continuous flow. At the same time the condensation layer also causes continuous removal of deposited particles from the deposition area. Even water-insoluble dust and poorly wet-able soot are washed off. The constantly renewed wetting prevents dry spots and sticking, which can cause *sparking* (electrical discharges between the electrodes). Avoiding sparking allows for a higher deposition voltage, which in turn leads to improved and consistent high deposition performance (see Figure 2.42).

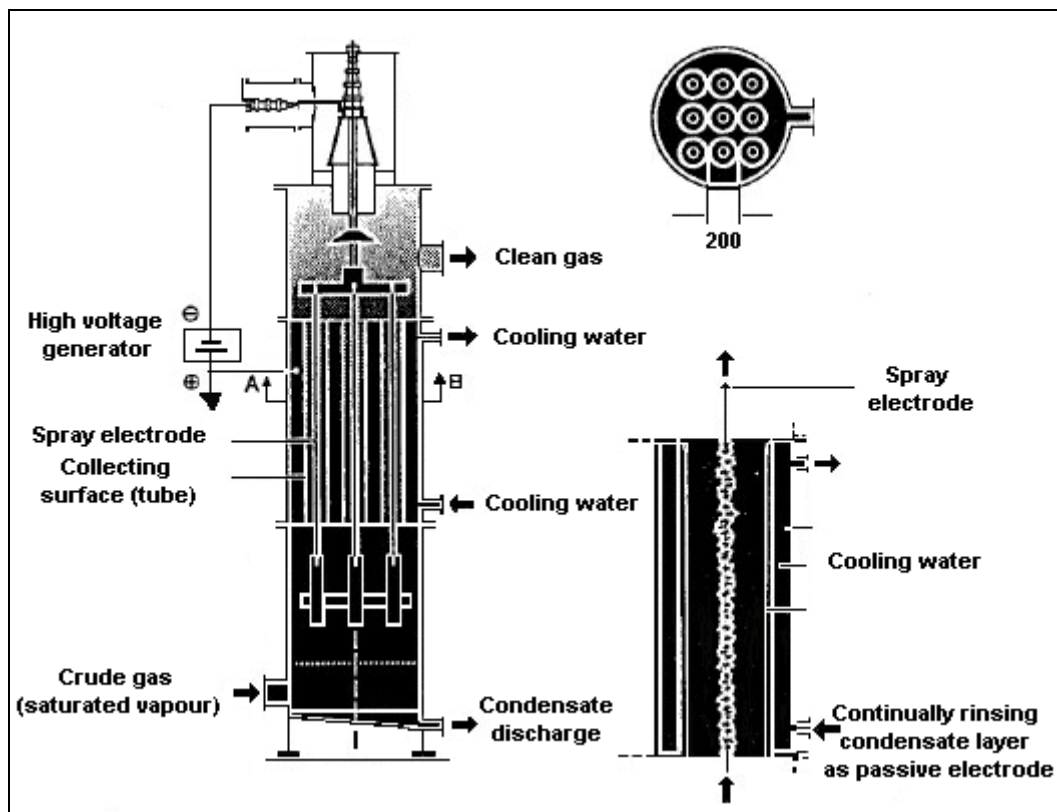

Figure 2.42: Condensation electrostatic precipitator

Source [1, UBA, 2001]

### 2.5.3.4 Ionisation wet scrubbers

[1, UBA, 2001] The purpose of the Ionisation Wet Scrubber (IWS) is to remove various pollutants from the flue-gas flow. The IWS combines the principles of:

- electrostatic charging of particles, electrostatic attraction and deposition for aerosols (smaller than 5  $\mu\text{m}$ )
- vertical deposition for coarse, liquid and solid particles (larger than 5  $\mu\text{m}$ ), and
- absorption of hazardous, corrosive and malodorous gases.

The IWS system is a combination of an electrostatic filter and a packed scrubber. It is reported to require little energy and has a high deposition efficiency for particles in the submicron as well as the micron range.

A high voltage zone is installed before each packed tower stage. The function of the high voltage zone is to ionise the particles (dust, aerosols, submicron particles) contained in the flue-gas. The negatively charged particles induce opposing charges on the neutral surface of the wetted packing material and the falling water drops. Because of this they are attracted and are then washed out in the packed section. This is referred to as Image/Force attraction (IF attraction), i.e. attraction through electron shift. Hazardous, corrosive and malodorous gases are also absorbed in the same scrubber fluid and chemically combined to be discharged with the scrubber effluent.

Another type of ionization wet scrubber includes a Venturi. The pressure changes that occur through the Venturi allows the fine particles to grow and the electrode charges them. They are then collected by the dense layer of water droplets projected by a nozzle, serving as collecting electrode. [74, TWGComments, 2004]

### 2.5.3.5 Fabric filters

Fabric filters, also called bag filters, are very widely used in waste incineration plants. Filtration efficiencies are very high across a wide range of particle sizes. At particle sizes below 0.1 microns, efficiencies are reduced, but the fraction of these that exist in the flue-gas flow from waste incineration plants is relatively low. Low dust emissions are achieved with this technology. It can also be used following an ESP and wet scrubbers. [74, TWGComments, 2004]

Compatibility of the filter medium with the characteristics of the flue-gas and the dust, and the process temperature of the filter are important for effective performance. The filter medium should have suitable properties for thermal, physical and chemical resistance (e.g. hydrolysis, acid, alkali, oxidation). The gas flowrate determines the appropriate filtering surface i.e. filtering velocity.

Mechanical and thermal stress on the filter material determines service life, energy and maintenance requirements.

In continuous operation, there is gradual loss of pressure across the filtering media due to the deposit of particles. When dry sorption systems are used, the formation of a cake on the media helps to provide the acid removal. In general, the differential pressure across the filter is used to monitor the need of cleaning. Periodic replacement is required when the residual lifetime is achieved or in the case of irreversible damage (e.g. an increasing loss of pressure may be caused by irreversible deposit of fine dust in the filter material). Several parameters help to control the lifetime of the bags: pressure drop drift, visual, microscopic analysis, etc. Potential leaks in the bag filter will also be detected by the increased emissions or by some process disturbance. [64, TWGComments, 2003]

The application of dry deposition is limited for dusts that are hygroscopic at high temperatures (300 to 600 °C) and become sticky at these temperatures. This type of dust forms deposits in the deposition equipment, which cannot be extracted sufficiently by conventional cleaning techniques during operation, but may need to be removed by ultrasound vibration. These may be dusts from complex salts e.g. from wastes containing phosphorus, sulphur or silicon.



**Figure 2.43: An example of a fabric filter**  
Source [1, UBA, 2001]

### 2.5.3.6 Cyclones and multi-cyclones

[64, TWGComments, 2003]

Cyclones and multicyclones use centrifugal forces to separate particulate matter from the gas stream. Multi-cyclones differ from single cyclones in that they consist of many small cyclone units. The gas flow enters the separator tangentially and leaves from a central port. Solids are forced to the outside of the cyclone and collected at the sides for removal.

In general, cyclones on their own cannot achieve the emission levels now applied to modern waste incinerators. They can, however, have an important role to play where applied as a pre-deduster before other flue-gas treatment stages. Energy requirements are generally low as there is no pressure drop across the cyclone.

Advantages of cyclones are their wide operational temperature range and robust construction. Erosion of cyclones, particularly at the point of impingement of dirty flue-gases, can be an issue where the flue-gas is more heavily loaded with particulate, and particularly where bed material escapes from fluidised bed plants. Circulating fluidised beds usually incorporate a cyclone for the removal and recirculation of the bed material to the furnace.

## 2.5.4 Techniques for the reduction of acid gases (e.g. HCl, HF and SO<sub>x</sub> emissions)

These substances are generally cleaned from the flue-gas using alkaline reagents. The following flue-gas cleaning processes are applied:

- **dry processes:** A dry sorption agent (e.g. lime, sodium bicarbonate) is added to the flue-gas flow. The reaction product is also dry
- **semi-wet processes:** Also called semi-dry, the sorption agent added to the flue-gas flow is an aqueous solution (e.g. lime milk) or suspension (e.g. as a slurry). The water solution evaporates and the reaction products are dry. The residue may be re-circulated to improve reagent utilisation. A sub-set of this technique are *flash-dry* processes which consist of injection of water (giving fast gas cooling) and reagent at the filter inlet
- **wet processes:** The flue-gas flow is fed into water, hydrogen peroxide, or/and a washing solution containing part of the reagent (e.g. sodium hydroxide solution). The reaction product is aqueous.

### 2.5.4.1 Removal of sulphur dioxide and halogens

[1, UBA, 2001] Sulphur dioxide and gaseous halogens are cleaned from flue-gases by the injection of chemical or physical sorption agents, which are brought into contact with the flue-gas. According to technique, the reaction products are dissolved or dry salts.

#### Dry systems:

In dry sorption processes the absorption agent (usually lime or sodium bicarbonate) is fed into the reactor as a dry powder. The dose rate of reagent may depend on the temperature as well as on reagent type. With lime this ratio is typically two or three times the stoichiometric amount of the substance to be deposited, with sodium bicarbonate the ratio is lower. This is required to ensure emission limits are complied with over a range of inlet concentrations. The reaction products generated are solid and need to be deposited from the flue-gas as dust in a subsequent stage, normally a bag filter.

The overdose of lime (or other reagent) leads to a corresponding increase in the amount of residues, unless reagent recirculation is carried out, when the un-reacted fraction can be recirculated and the stoichiometric ratio reduced accordingly.

If there is no pre-deposition stage (e.g. electrostatic precipitator), particles are removed with the used reagent and reaction products. The cake of reagent that forms on fabric filters gives effective contact between flue-gas and absorbent.

Plumes are rarely visible with this technique.

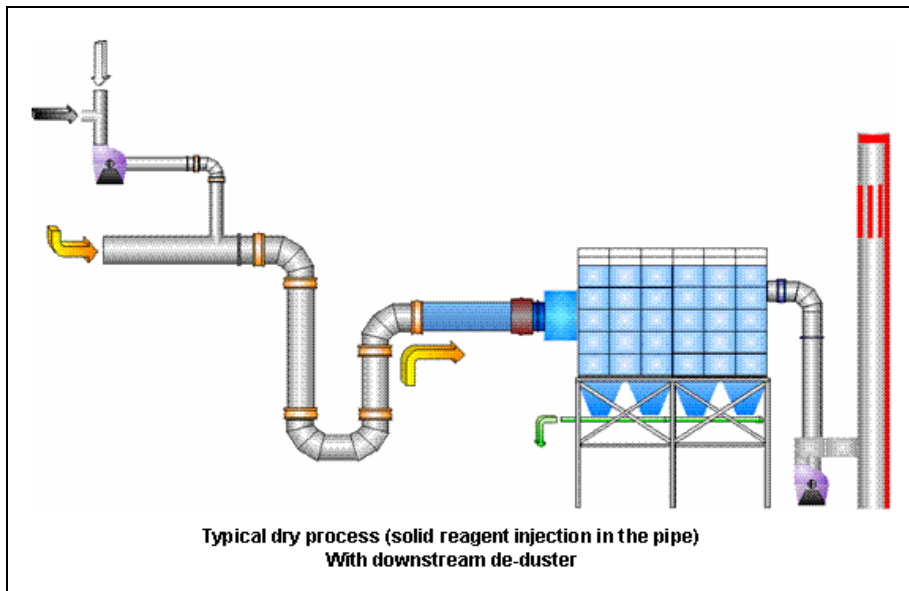

**Figure 2.44: Schematic diagram of a dry FGT system with reagent injection to the FG pipe and downstream bag filtration**

Semi-wet systems:

These are also called *semi-dry* processes. In the spray absorption, the absorption agent is injected either as suspension or solution into the hot flue-gas flow in a spray reactor (see Figure 2.45).

This type of process utilises the heat of the flue-gas for the evaporation of the solvent (water). The reaction products generated are solid and need to be deposited from the flue-gas as dust in a subsequent stage e.g. bag filter. These processes typically require overdoses of the sorption agent of 1.5 to 2.5.

Here, the fabric filter is also an important part of the process. Plumes are also rarely visible with this technique.

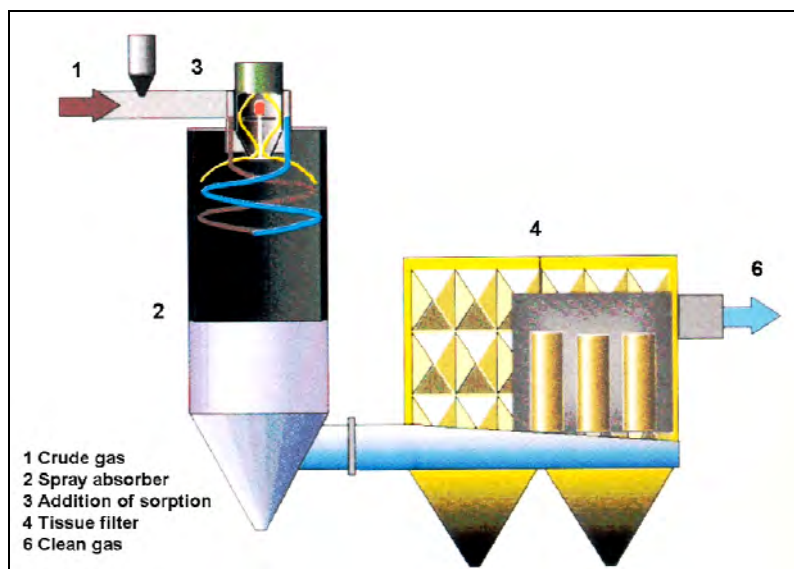

**Figure 2.45: Operating principle of a spray absorber**  
[1, UBA, 2001]



A system which falls between the normal dry and semi-wet systems is also applied. This is sometimes known as a flash-dry system. (Alstom 2003) These systems re-inject into the inlet flue-gas a proportion of the solids collected on a bag filter. Water is added at a controlled rate to the collected fly ash and reagent to ensure that it remains free flowing and not prone to stickiness or scaling. No contact tower or slurry handling is required (cf. semi-wet systems) and no effluents are produced (cf. wet systems).

The recycling of reagent reduces demand for reagent and the amount of solid residue produced. Stoichiometric ratios in the range of 1.5 to 2 are common. Recycling of reagent can also be applied to dry and semi-wet systems.

#### Wet systems:

Wet flue-gas cleaning processes use different types of scrubber design. For example:

- jet scrubbers
- rotation scrubbers
- venturi scrubbers
- dry tower scrubbers
- spray scrubbers
- packed tower scrubbers.

The scrubber solution is (in the case of water only injection) strongly acidic (typically pH 0 - 1) due to acids forming in the process of deposition. HCl and HF are mainly removed in the first stage of the wet scrubber. The effluent from the first stage is recycled many times, with small fresh water addition and a bleed from the scrubber to maintain acid gas removal efficiency. In this acidic medium, deposition of SO<sub>2</sub> is low, so a second stage scrubber is required for its removal.

Removal of sulphur dioxide is achieved in a washing stage controlled at a pH close to neutral or alkaline (generally pH 6 - 7) in which caustic soda solution or lime milk is added. For technical reasons this removal takes place in a separated washing stage, in which, additionally, there occurs further removal of HCl and HF.

If the treated waste contains bromine and iodine, these elements can be deposited from the flue-gas flow if waste containing sulphur is combusted simultaneously. In addition to sulphur compounds, water-soluble salts of bromine and iodine will form, which can be deposited through the wet SO<sub>2</sub> flue-gas cleaning processes. Additionally, the deposition of elementary bromine and iodine may be improved by specific employment of reductive washing stages (sulphite solution, bisulphite solution). In any case, it is important to be aware of which wastes contain iodine or bromine.

If lime milk or limestone is used as a neutralising agent in the wet flue-gas cleaning stages, sulphate (as gypsum), carbonates and fluorides will accumulate as water-insoluble residues. These substances may be removed to reduce the salt load in the waste water and hence reduce the risk of encrustation within the scrubbing system. Residues of the cleaning process (e.g. gypsum) can be recovered. When using a caustic soda solution there is no such risk because the reaction products are water-soluble. If NaOH is used, CaCO<sub>3</sub> may form (depending upon water hardness), which will again lead to deposits within the scrubber. These deposits need to be removed periodically by acidification.

The diagram below shows a typical 2 stages wet scrubbing system. The number of scrubbing stages usually varies between 1 and 4 with multiple stages being incorporated in each vessel:

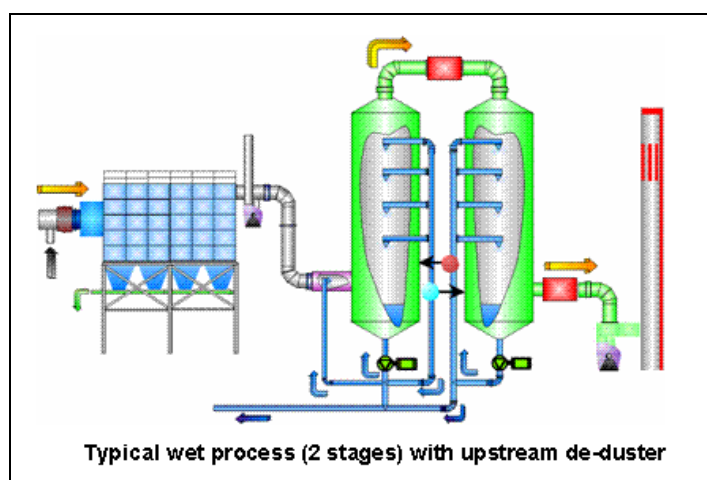

**Figure 2.46: Diagram of a 2 stage wet scrubber with upstream de-dusting**

#### Waste water from wet scrubbers:

To maintain scrubbing efficiency and prevent clogging in the wet scrubber system, a portion of the scrubber liquor must be removed from the circuit as waste water. This waste water must be subjected to special treatment (neutralisation, precipitation of heavy metals), before discharge or use internally. Mercury removal is given special attention. Volatile Hg compounds, such as  $\text{HgCl}_2$ , will condense when flue-gas is cooled, and dissolve in the scrubber effluent. The addition of reagents for the specific removal of Hg provides a means for removing it from the process.

In some plants, the waste water produced is evaporated in the incineration plant by spraying it back into the flue-gas as a quench in combination with a dust filter.

#### **2.5.4.2 Direct desulphurisation**

[1, UBA, 2001] Desulphurisation in fluidised bed processes can be carried out by adding absorbents (e.g. calcium or calcium/magnesium compounds) directly into the incineration chamber. Additives such as limestone dust, calcium hydrate and dolomitic dust are used. The system can be used in combination with downstream flue-gas desulphurisation.

The arrangement of the jets and the injection speed influence the distribution of the absorbents and thus the degree of sulphur dioxide deposition. Part of the resulting reaction products are removed in filter installations downstream; however, a significant proportion remains with the bottom ashes. Therefore, direct desulphurisation may impact on bottom ash quality [64, TWGComments, 2003].

Ideal conditions for direct desulphurisation exist in a cycloid furnace due to the constant temperature level.

It is reported that, on its own, this techniques does not lead to compliance with the ELV requirements of Directive 2000/76/EC. [1, UBA, 2001]. The amount of residue from the flue-gas treatment system itself can be reduced, resulting in lower disposal costs.

Absorption (and adsorption) of pollutants can also be performed in a (circulating) fluid bed reactor into which residues and reagents are recirculated in the combustor at a high rate. Recirculation of flue-gas keeps the gas flow above a minimum level in order to maintain fluidisation of the bed. The bed material is separated in a bag filter. Injection of water reduces the consumption of absorbents (and hence the production of residues) significantly. [74, TWGComments, 2004]

## 2.5.5 Techniques for the reduction of emissions of oxides of nitrogen

[3, Austria, 2002]

Nitrogen oxides ( $\text{NO}_x$ ) may be formed in three ways:

- thermal  $\text{NO}_x$ : During combustion a part of the air nitrogen is oxidised to nitrogen oxides. This reaction only takes place significantly at temperatures above 1300 °C. The reaction rate depends exponentially on the temperature and is directly proportional to the oxygen content
- fuel  $\text{NO}_x$ : during combustion a part of the nitrogen contained in the fuel is oxidised to nitrogen oxides
- formation of  $\text{NO}_x$  via radical reaction (prompt  $\text{NO}_x$ ): Atmospheric nitrogen can also be oxidised by reaction with CH radicals and intermediate formation of HCN. This mechanism of formation is of relatively low importance in waste incineration.

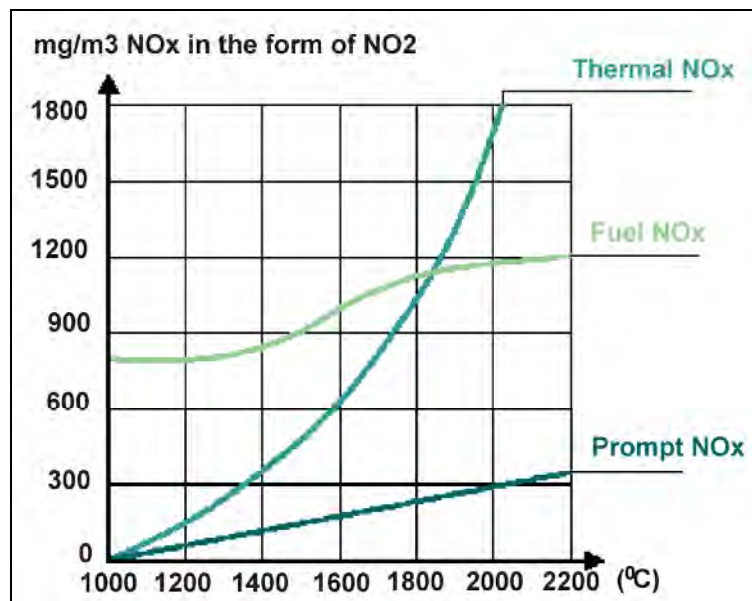

Figure 2.47: Temperature dependence of various  $\text{NO}_x$  formation mechanisms in waste incineration  
Source [3, Austria, 2002]

### 2.5.5.1 Primary techniques for $\text{NO}_x$ reduction

[1, UBA, 2001]  $\text{NO}_x$  production can be reduced using furnace control measures that:

- prevent over supply of air (i.e. prevention of the supply of additional nitrogen)
- prevent the use of unnecessarily high furnace temperatures (including local hot spots).

#### 2.5.5.1.1 Air supply, gas mixing and temperature control

The use of a well distributed primary and secondary air supply to avoid the uneven temperature gradients that result in high temperature zones and, hence, increased  $\text{NO}_x$  production is a widely adopted and important primary measure for the reduction of  $\text{NO}_x$  production.

Although sufficient oxygen is required to ensure that organic materials are oxidised (giving low CO and VOC emissions), the over supply of air can result in additional oxidation of atmospheric nitrogen, and the production of additional  $\text{NO}_x$ .

Achieving effective gas mixing and temperature control are important elements.

#### 2.5.5.1.2 Flue-Gas Recirculation (FGR)

This technique involves replacement of around 10 - 20 % of the secondary combustion air with recirculated flue-gases. NO<sub>x</sub> reduction is achieved because the supplied re-circulated flue-gases have lower oxygen concentration and therefore lower flue-gas temperature which leads to a decrease of the nitrogen oxide levels. [74, TWGComments, 2004]

#### 2.5.5.1.3 Oxygen injection

The injection of either pure oxygen or oxygen enriched air provides a means to supply the oxygen required for combustion, while reducing the supply of additional nitrogen that may contribute to additional NO<sub>x</sub> production.

#### 2.5.5.1.4 Staged combustion

Staged combustion has been used in some cases. This involves reducing the oxygen supply in the primary reaction zones and then increasing the air (and hence oxygen) supply at later combustion zones to oxidise the gases formed. Such techniques require effective air/gas mixing in the secondary zone to ensure CO (and other products of incomplete combustion) are maintained at low levels.

#### 2.5.5.1.5 Natural gas injection (re-burn)

[70, USEPA, 1994]

Natural gas injection into the over-grate region of the furnace can be used to control NO<sub>x</sub> emissions from the combustor. For MSWIs, two different natural gas based processes have been developed:

- Re-burning – a three stage process designed to convert NO<sub>x</sub> to N<sub>2</sub> by injecting natural gas into a distinct re-burn zone located above the primary combustion zone
- Methane de-NO<sub>x</sub> – this technique injects natural gas directly into the primary combustion unit to inhibit NO<sub>x</sub> formation.

#### 2.5.5.1.6 Injection of water into furnace/flame

A properly designed and operated injection of water either into the furnace or directly into the flame can be used to decrease the hot spot temperatures in the primary combustion zone. This drop in peak temperature can reduce the formation of thermal NO<sub>x</sub>.

[74, TWGComments, 2004]

### 2.5.5.2 Secondary techniques for NO<sub>x</sub> reduction

[1, UBA, 2001] Directive 2000/76/EC requires a daily average NO<sub>x</sub> (as NO<sub>2</sub>) clean gas value of 200 mg/Nm<sup>3</sup>. In order to achieve compliance at this level, it is common for secondary measures to be applied. For most processes the application of ammonia or derivatives of ammonia (e.g. urea) as reduction agent has proved successful. The nitrogen oxides in the flue-gas basically consist of NO and NO<sub>2</sub> and are reduced to nitrogen N<sub>2</sub> and water vapour by the reduction agent.

Reaction equations:

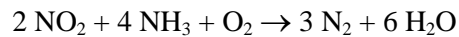
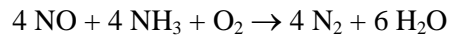

Two processes are important for the removal of nitrogen from flue-gases - the Selective Non-Catalytic Reduction (SNCR) and the Selective Catalytic Reduction (SCR).

Both  $\text{NH}_3$  and urea are applied in aqueous solutions.  $\text{NH}_3$  is normally, for safety reasons, delivered as a 25 % solution.

### 2.5.5.2.1 Selective Non-Catalytic Reduction (SNCR) process

In the Selective Non-Catalytic Reduction (SNCR) process nitrogen oxides ( $\text{NO} + \text{NO}_2$ ) are removed by selective non-catalytic reduction. With this type of process the reducing agent (typically ammonia or urea) is injected into the furnace and reacts with the nitrogen oxides. The reactions occur at temperatures between 850 and 1000 °C, with zones of higher and lower reaction rate within this range.

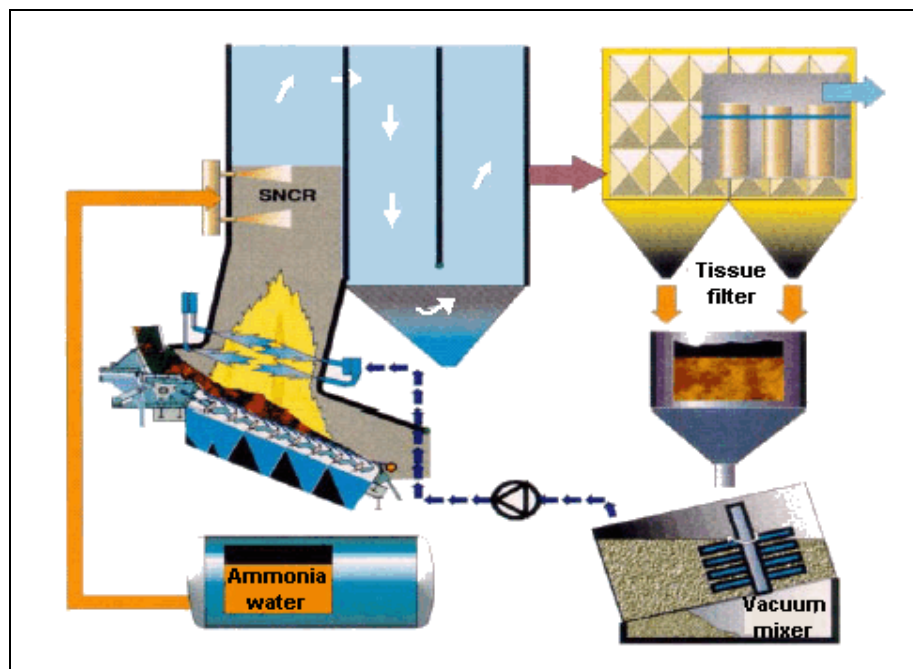
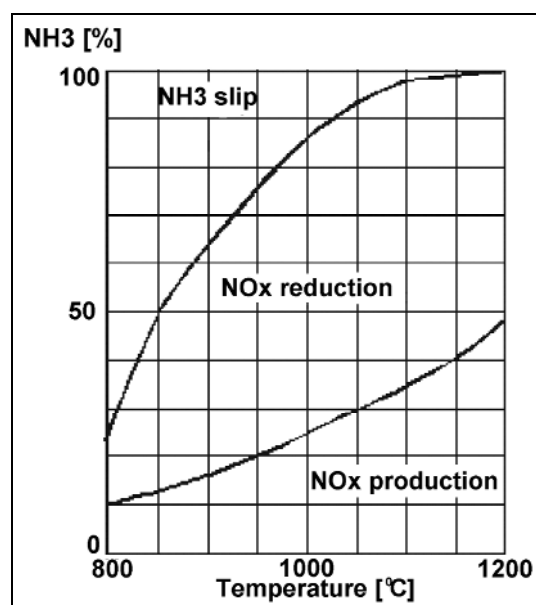

Figure 2.48: SNCR operating principle  
[1, UBA, 2001]

Reducing  $\text{NO}_x$  by SNCR more than 60 – 80 %, requires a higher addition of the reducing agent. This can lead to emissions of ammonia, also known as *ammonia slip*. The relationship between  $\text{NO}_x$  reduction, ammonia slip and reaction temperature is given in Figure 2.49 below:



**Figure 2.49: Relationship between NO<sub>x</sub> reduction, production, ammonia slip and reaction temperature for the SNCR process**  
[Austria, 2002 #3] [64, TWGComments, 2003]

In Figure 2.49, it is shown that, at a reaction temperature of, for example, 1000 °C, the reduction of NO<sub>x</sub> would be about 85 %, and there would be an ammonia slip of about 15 %. In addition, at this temperature there would be a production of NO<sub>x</sub>, from the incineration of the injected NH<sub>3</sub>, of about 25 %.

Figure 2.49 also shows that, at higher temperatures (with ammonia), the percentage of NO<sub>x</sub> reduction is higher, and while the ammonia slip is lower, the NO<sub>x</sub> produced from the ammonia rises. At high temperatures, (>1200 °C) NH<sub>3</sub> itself oxidises and forms NO<sub>x</sub>. At lower operational temperatures the NO<sub>x</sub> reduction is less efficient, and ammonia slip is higher.

Application of urea instead of ammonia in SNCR leads to relatively higher N<sub>2</sub>O emissions in comparison with ammonia reduction. [64, TWGComments, 2003]

In order to ensure an optimum utilisation of ammonia at varying degrees of load, which cause varying temperatures in the combustion chamber, NH<sub>3</sub> can be injected at several layers.

When used with wet scrubbing systems, the excess ammonia may be removed in the wet scrubber. The ammonia can then be recovered from the scrubber effluent using an ammonia stripper and fed back to the SNCR feed system.

Important for optimisation of the SNCR process is the effective mixing of flue-gases and NO<sub>x</sub> reduction reagent, and sufficient gas residence time to allow the NO<sub>x</sub> reduction reactions to occur.

In the case of pyrolysis and gasification processes, optimisation of SNCR is achieved by injecting the reagent into the syngas combustion zones with a well controlled temperature and effective gas mixing.

### 2.5.5.2.2 Selective Catalytic Reduction (SCR) process

Selective Catalytic Reduction (SCR) is a catalytic process during which ammonia mixed with air (the reduction agent) is added to the flue-gas and passed over a catalyst, usually a mesh (e.g. platinum, rhodium,  $\text{TiO}_2$ , zeolites). [74, TWGComments, 2004] When passing through the catalyst, ammonia reacts with  $\text{NO}_x$  to give nitrogen and water vapour.

To be effective, the catalyst usually requires a temperature of between 180 and 450 °C. The majority of systems used in waste incinerators currently operate in the range 230 - 300 °C. Below 250 °C more Catalyst volume is necessary and there is a greater risk of fouling and catalyst poisoning. In some cases catalyst temperature regulated bypasses are used to avoid damage to the SCR unit. [74, TWGComments, 2004]

The SCR process gives high  $\text{NO}_x$  reduction rates (typically over 90 %) at close to stoichiometric additions of the reduction agent. For waste incineration, SCR is mainly applied in the clean gas area i.e. after de-dusting and acid gas removal. For this reason, the flue-gases generally require reheating to the effective reaction temperature of the SCR system. This adds to the energy requirements of the flue-gas treatment system. However, when  $\text{SO}_x$  levels in the flue-gas have already been reduced to a very low value at the inlet of the SCR section, reheating may be reduced substantially, or even omitted. Heat exchangers are used to reduce additional energy demand.

After a wet FGT system, droplets may be removed to prevent salt deposits inside the catalyst. Due to risk of ignition, safety measures are of importance, e.g. by passes, CO control, etc. [74, TWGComments, 2004]

Low-temperature SCR requires catalyst regeneration due to salts formation (especially ammonium chloride and ammonium sulphate). The regeneration may be critical because of the salt sublimation may lead to exceedences of the applied ELV for releases to air for some pollutants e.g. HCl,  $\text{SO}_2$ ,  $\text{NO}_x$ . [74, TWGComments, 2004]

SCR is sometimes positioned directly after the ESP, to reduce or eliminate the need for reheating in the flue-gas. When this option is used, the additional risk of PCDD/F formation in the ESP (typically when the ESP operated at temperatures above 220 - 250 °C) must be considered. Such operation can result in increased PCDD/F emissions to ESP residues and higher concentrations in the gas stream leaving the ESP and passing to the SCR unit.. SCR can also be used for PCDD/F destruction. Multi layer SCR systems are used to provide combined  $\text{NO}_x$  and PCDD/F control.

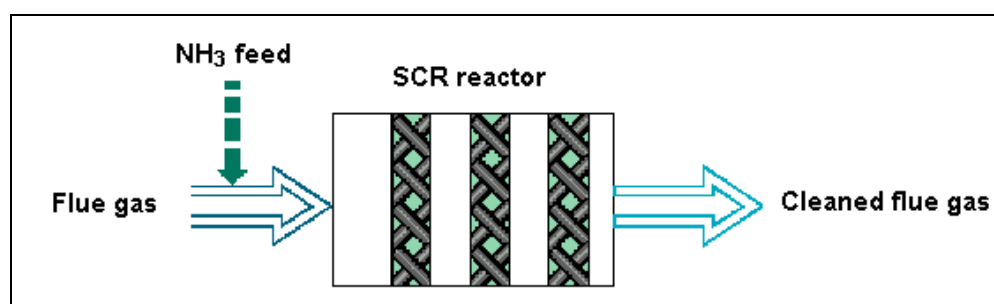

Figure 2.50: SCR operating principle  
[3, Austria, 2002]

The flue-gases discharged by the reactor may be directed through a gas-gas heat-exchanger to preheat the entering gases in order to maintain the operating temperature of the catalyst and to save a part of the imported energy (see diagrams in Section 4.4.4.1).

## 2.5.6 Techniques for the reduction of mercury emissions

### 2.5.6.1 Primary techniques

Mercury is highly volatile and therefore almost exclusively passes into the flue-gas stream. The limit value set in the waste incineration directive is  $0.05 \text{ mg/m}^3$ . Limit values as low as  $0.03 \text{ mg/m}^3$  as a daily average value (with continuous monitoring) have been set in some European Member States [1, UBA, 2001]. Continuous measurement is also prescribed in some national waste incineration legislation (e.g. Austria, Germany). The majority of installations cannot meet these limit values, particularly for peak loads, without the addition of special gas cleaning measures for Hg.

The only relevant primary techniques for preventing emissions of mercury to air are those which prevent or control, if possible, the inclusion of mercury in the waste:

- efficient separate collection of waste that may contain heavy metals e.g. cells, batteries, dental amalgams, etc.
- notification of waste producers of the need to segregate mercury
- identification and/or restriction of receipt of potential mercury contaminated wastes
  - by sampling and analysis of wastes where this is possible
  - by targeted sampling/testing campaigns
- where such wastes are known to be received - controlled addition to avoid overload of abatement system capacity.

### 2.5.6.2 Secondary techniques

[1, UBA, 2001]Mercury vaporises completely at a temperature of  $357 \text{ }^\circ\text{C}$  and remains gaseous in the flue-gas after passing through furnace and boiler. Inorganic mercury (mainly  $\text{Hg}^{2+}$  as a chloride) and elemental mercury are effected differently by FGT systems and detailed consideration of the fate of both is required.

The selection of a process for mercury abatement depends upon the load fed in and upon the chlorine content of the burning material. At higher chlorine contents, mercury in the crude flue-gas will be increasingly in the ionic form which can be deposited in wet scrubbers. This is a particular consideration at sewage sludge incineration plants where raw gas chlorine levels may be quite low. If, however, the chlorine content in the (dry) sewage sludge is 0.3 % by mass or higher, only 10 % of the mercury in the clean gas is elemental; and the elimination of only the ionic mercury may achieve a total Hg emission level of  $0.03 \text{ mg/Nm}^3$ . [74, TWGComments, 2004]

Metallic mercury can be removed from the flue-gas stream by:

- transformation into ionic mercury by adding oxidants and then deposited in the scrubber - the effluent can then be fed to waste water treatment plants with heavy metal deposition, where the mercury can be converted to a more stable form (e.g. HgS), thus more suitable for final disposal [74, TWGComments, 2004] or
- direct deposition on sulphur doped activated carbon, hearth furnace coke, or zeolites.

Tests have shown that sulphur dioxide neutralisation in the furnace by adding limestone, can reduce the proportion of metallic mercury, making overall Hg removal from the gas stream more efficient.

In incineration plants for municipal and hazardous wastes, the chlorine content in the average waste is usually high enough, in normal operating states, to ensure that Hg is present mainly in the ionic form. However, specific inputs of certain waste may change the situation and metallic mercury may need to be deposited, as mentioned above.



High Hg wastes:

For the incineration of waste with a high mercury content in hazardous waste incineration plants Hg deposition degrees of 99.9 % can only be ensured when highly chlorinated waste is also incinerated in an appropriate proportion to the Hg load. Multistage wet scrubbing processes are typical of this type of plant. High proportions of ionic Hg (e.g. >99.9 %) in the boiler crude flue-gas before wet gas cleaning are caused by including highly chlorinated waste. This assists total Hg removal from the flue-gas.

High chlorine total loads (approx. 4 % w/w input) and a therefore high interim Cl<sub>2</sub> supply lead to high Hg chlorination levels and Hg deposition of close to 100 %. With lower chlorine loads the Hg deposition degree reduces rapidly.

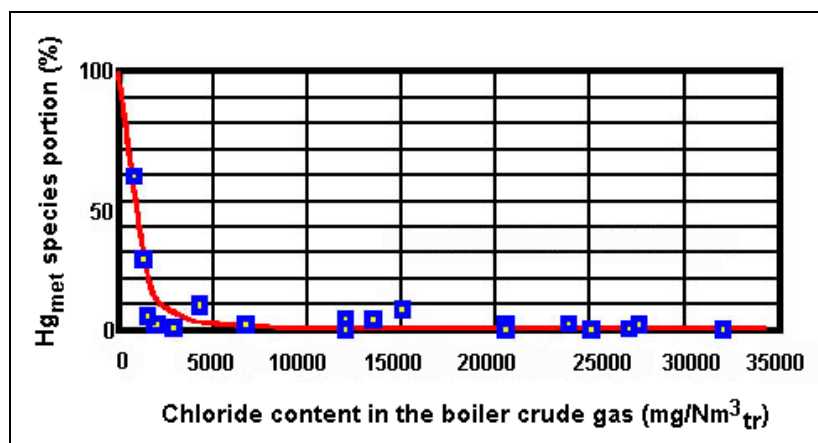

Figure 2.51: Relationship between Hg emissions and the raw gas chloride content at a hazardous waste incineration plant

Source [1, UBA, 2001]

### 2.5.7 Techniques for the reduction of other emissions of heavy metals

[1, UBA, 2001] Other heavy metals in incineration are converted mainly into non-volatile oxides and deposited with flue ash. Thus, the main techniques of relevance are, therefore, those applicable to dust removal (see Section 2.5.3).

Activated carbon is reported to be also used for reducing heavy metals emissions [74, TWGComments, 2004]

### 2.5.8 Techniques for the reduction of emissions of organic carbon compounds

Effective combustion provides the most important means of reducing emissions to air of organic carbon compounds.

[1, UBA, 2001] Flue-gas from waste incineration plants can contain trace quantities of a very wide range of organic species including:

- halogenated aromatic hydrocarbons
- polycyclic aromatic hydrocarbons (PAH)
- benzene, toluene and xylene (BTX)
- PCDD/F.

Polychlorinated dibenzo-p-dioxins (PCDD) and dibenzofurans (PCDF) may form after the furnace from precursor compounds. Precursor compounds are, for example, polychlorinated biphenyls (PCB), polychlorinated diphenylmethanes (PCDM), chlorobenzenes and chlorohydroxybenzenes.

PCDD and PCDF may also form in catalytic reactions of carbon or carbon compounds with inorganic chlorine compounds over metal oxides, e.g. copper. These reactions will occur especially on fly ash or filter dust at temperatures between 200 and 450 °C.

The following three mechanisms are believed to lead to the formation of dioxin/furan in waste incineration:

1. formation of PCDD/F from chlorinated hydrocarbons already in, or formed in the furnace, (such as chlorohydrobenzene or chlorobenzene)
2. de-novo synthesis in the low-temperature range (typically seen in boilers, dry ESPs)
3. incomplete destruction of the PCDD/F supplied with the waste

Optimum flue-gas incineration largely destroys the precursor compounds. The formation of PCDD/PCDF from the precursor compounds is, therefore, suppressed.

The emission limit value for the total of dioxins and furans in Directive 2000/76/EC is 0.1 ng I-TEQ/m<sup>3</sup>. Adsorption processes and oxidising catalysts are available, amongst others, for achieving this value. Oxidising catalysts are reported to also reduce emission of NH<sub>3</sub>-slip and CO. [74, TWGComments, 2004]

Emissions of organic hydrocarbon compounds can also be reduced by further dust and aerosol deposition, since these pollutant preferably adsorb onto the fine fraction of dust, and by enforced flue-gas cooling (condensation).

### 2.5.8.1 Adsorption on activated carbon reagents in an entrained flow system

Activated carbon is injected into the gas flow. The carbon is filtered from the gas flow using bag filters. The activated carbon shows a high absorption efficiency for mercury as well as for PCDD/F.

Different types of activated carbon have different adsorption efficiencies. This is believed to be related to the specific nature of the carbon particles, which are, in turn, influenced by the manufacturing process.

### 2.5.8.2 SCR systems

SCR systems are used for NO<sub>x</sub> reduction (see description in Section 2.5.5.2.2). They also destroy gaseous PCDD/F (not particle bound) through catalytic oxidation; however, in this case, the SCR system must be designed accordingly, since it usually requires a bigger, multi-layer, SCR system than for just the de-NO<sub>x</sub> function. Destruction efficiencies for PCDD/F of 98 to 99.9 % are seen.

The main reactions involved are: [74, TWGComments, 2004]

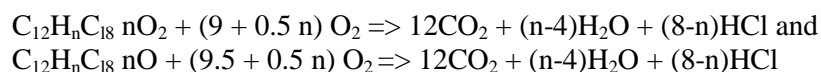

### 2.5.8.3 Catalytic bag filters

(Belgium 2002) Filter bags are either impregnated with a catalyst, or the catalyst is directly mixed with organic material in production of fibres. Such filters have been used to reduce PCDD/F emissions.

Gaseous PCDD/F can be destroyed on the catalyst rather than adsorbed in carbon (as with carbon injection systems). The particle bound PCDD/F fraction can be removed by filtration. The catalyst has no effect on mercury and therefore it is generally necessary to implement additional techniques (such as activated carbon or sulphur reagent etc.) to remove mercury in order to meet the modern Emission Limit Value in air. [74, TWGComments, 2004]

The gas temperature entering the filter bags should be above 190 °C in order to have effective destruction of the PCDD/F and to prevent adsorption of PCDD/F in the media. [74, TWGComments, 2004]

#### 2.5.8.4 Re-burn of carbon adsorbents

[55, EIPPCBsitevisits, 2002] Carbon is used to adsorb dioxins (and mercury) at many waste incinerators. Where processes have another outlet for the mercury that provides an adequate removal rate, (i.e. a greater rate than the input rate to avoid circulation and hence emission breakthrough) it is possible for the net dioxin emissions from the plant to be reduced by re-burning the adsorbed PCDD/F by re-injection into the furnace. Usually the additional mercury removal is provided by a low pH wet scrubbing system. Gas streams with low HCl concentration may not find there are sufficient mercury removal rates to use this process.

Examples of the application of this technique include the re-burn of:

- static coke bed adsorbents
- entrained flow activated carbon adsorbents
- carbon impregnated inserts used to adsorb dioxins in wet scrubbers and prevent memory effects.

In some MSs local regulations do not allow re-burn.

#### 2.5.8.5 Use of carbon impregnated plastics for PCDD/F adsorption

[58, Andersson, 2002] Plastics are widely used in the construction of flue-gas cleaning equipment due to their excellent corrosion resistance. PCDD/F is adsorbed on these plastics in wet scrubbers, where the typical operational temperature is 60 – 70 °C. If the temperature is increased by only a few degrees Celsius, or if the dioxin concentration in the gas is reduced the adsorbed PCDD/F can be desorbed to the gas phase and increase emissions to air. Lower chlorinated PCDD/Fs are subject to the highest de-sorption rate increase with respect to temperature rise. These can lead to increased TEQ values downstream of wet scrubbers.

The addition of a tower packing in the scrubber that contains polypropylene embedded with carbon provides a means of selectively absorbing PCDD/F (Hg is not absorbed in the packing). This material becomes saturated after a certain period of time. Therefore the charged material can periodically be removed for disposal or, if permitted, burned in the furnace. [74, TWGComments, 2004]

With inlet concentrations of 6 – 10 ng TEQ/Nm<sup>3</sup>, gas phase removal efficiencies in the range of 60 – 75 % are reported across a wet scrubber. This compares with 0 – 4 % without the impregnated packing material. Absorption efficiency is reported not to decline not to have declined over the test period (1 year). [58, Andersson, 2002]. [74, TWGComments, 2004]

An installation, like the one reported above, achieves outlet concentration of 2 – 3 ng TEQ/Nm<sup>3</sup> which do not, on their own, comply with the 0.1 ng/Nm<sup>3</sup> requirement of Directive 2000/76/EC. The technique can also be used in a more extensive tower packing installation and/or in combination with subsequent up-stream or downstream dioxin FGT to provide overall PCDD/F compliance (also for start-up and with FGT devices in bypass). [74, TWGComments, 2004]

### 2.5.8.6 Static bed filters

[1, UBA, 2001] Activated coke moving bed filters are used as a secondary cleaning process in the flue-gas of municipal and hazardous waste incineration. Using this adsorption system, it is possible to deposit substances contained in the flue-gas at extremely low concentrations with high efficiency. Lignite coke produced in hearth furnace coke process is used in moving bed absorbers.

Wet and dry coke beds are used in waste incineration. Wet systems have the addition of a countercurrent flow of water that washes the cokes. In doing so, the reactor temperature is lowered and some of the accumulated pollutants are washed from the filter. When activated lignite is used in the place of cokes/coal, it does not require the preheating of the flue-gas above the acid dew point and can even be effectively operated with “wet” or water saturated flue-gas. For this reason the activated lignite absorber can be placed directly behind a wet flue-gas scrubber. [64, TWGComments, 2003]

The flue-gases pass through a filling of grained Hearth Furnace Coke (HFC – a fine coke of 1.25 to 5 mm). The HFC’s depositing effect is essentially based upon mechanisms of adsorption and filtration. It is thus possible to deposit almost all emission relevant flue-gas components, in particular, residual contents of hydrochloric acid, hydrofluoric acid, sulphur oxides, heavy metals (e.g. mercury), to sometimes below the detection limit.

An essential feature of the moving bed system is its high efficiency with all emissions due to the large bulk of activated coke, so that variations from incineration and upstream flue-gas cleaning caused by operation will not cause disadvantageous effects.

The flue-gas is guided to the activated coke filling over a distributor bed equipped with a multitude of double funnels. The gas flows through them from the bottom to the top, while the HFC passes through the absorber from the top to the bottom. By this, an ideal distribution of the flue-gas over the whole cross-section of the absorber and an optimal utilisation of the absorber capacity is achieved at a minimum consumption of activated coke.

Operating results from plants of an industrial scale (municipal and hazardous waste incineration) have shown that the emission values, in particular for dioxins/furans, are well below the limit values of Directive EC 2000/76/EC.

Care is required with such processes, to ensure temperature and CO are well monitored and controlled, to prevent fires in the coke filter. This filter may become saturated after a certain period of time and should then be disposed of and replaced.

### 2.5.8.7 Rapid quenching of flue-gases

This technique involves the use of a water scrubber to cool flue-gases directly from their combustion temperature to below 100 °C. The technique is used in some HWI. The action of rapid quenching reduces the residence of flue-gases in temperature zones that may give rise to additional de-novo PCDD/F synthesis.

The scrubber must be designed to cope with the high particulate (and other pollutant) loads that will be transferred to the scrubber water.

The scrubbers used are single or multi stage, with the later stages sometimes cooled to reduce evaporative water losses with the flue-gas.

A boiler is not used and energy recovery is limited to heat transfer from the hot scrubber liquors.

## 2.5.9 Reduction of greenhouse gases (CO<sub>2</sub>, N<sub>2</sub>O)

[1, UBA, 2001] There are essentially two ways of reducing greenhouse gas emissions:

- increase the efficiency of energy recovery and supply (see Sections 2.4 and 4.3)
- control CO<sub>2</sub> emissions using flue-gas treatment.

Production of sodium carbonate by reacting CO<sub>2</sub> in the flue-gases with NaOH is possible. This technique is discussed further in Section 6.5 on emerging techniques.

### 2.5.9.1 Prevention of nitrous oxide emissions

Emissions of nitrous oxide from waste incineration can arise from:

- use of lower combustion temperatures – typically this becomes of interest below 850 °C
- the use of SNCR for NO<sub>x</sub> reduction (particularly where urea is the reagent chosen).

[71, JRC(IoE), 2003] The optimum temperature for the simultaneous minimisation of both NO<sub>x</sub> and N<sub>2</sub>O production is reported to be in the range 850 – 900 °C. Under conditions where the temperature in the post combustion chamber is above 900 °C the N<sub>2</sub>O emissions are reported to be low. N<sub>2</sub>O emissions from the use of SCR are also low. Thus, provided combustion temperatures are above 850 °C, in general, SNCR represents the only significant source of N<sub>2</sub>O emissions at modern waste incinerators.

If not properly controlled, SNCR, especially with urea, can give rise to increased emissions of nitrous oxide. Similarly, it is possible for nitrous oxide to be emitted from process with sub-stoichiometric oxygen supply levels (e.g. gasification and pyrolysis process) and also from fluidised bed furnaces operated under certain conditions. [74, TWGComments, 2004]

To avoid nitrous oxide emissions, the following techniques are used:

- reduction of SNCR reagent dosing by SNCR process optimisation
- selecting optimised temperature window for SNCR reagent injection
- use of flow modelling methods to optimise injection nozzle locations
- designing to ensure effective gas/reagent mixing in the appropriate temperature zone
- over-stoichiometric burnout zones to ensure oxidation of nitrous oxide
- utilization of ammonia instead of urea in SNCR.

## 2.5.10 Overview of flue-gas treatments applied at hazardous waste incinerators

This section provides an overview of the flue-gas treatment techniques that are applied in the Merchant HWI sector in Europe. For detailed descriptions of the FGT techniques themselves see earlier in this chapter.

[EURITS, 2002 #41] After the steam generator or quench cooling, the flue-gases pass through the flue-gas cleaning section. In almost 40 % of the installations, this section starts with a **spray dryer** or a similar technique to cool the gases further, and to evaporate the waste water (in those installations that do not have water discharges). Other installations just have an **intermediate quench** step in order to reduce the flue-gas temperature for further treatment (e.g. 250 °C to 60 °C).

Different techniques are used to reduce the concentrations of polluting components in the flue-gases; these are described below.

Scrubber systems are used to reduce the acid components (e.g. as below Cl, S) in the flue-gases. Almost 80 % of the installations are equipped with an acidic and an alkali **wet scrubber** system, of which 30 % have an additional scrubber system for removal of specific components (e.g. Br, I, Hg). The remaining 20 % use a **dry scrubber** with lime injection or the injection of bicarbonate.

To decrease the amount of dust and heavy metals in the flue-gas, **Electrostatic Precipitators (ESPs)** and **bag-house filters** are used:

- 54 % of the installations are equipped with a dry ESP (one installation with a wet ESP)
- 70 % of the installations are equipped with a bag-house filter
- 25 % of the installations combine these two techniques
- one installation is equipped with two bag-house filters installed.

ESPs systems are normally installed in the front end of wet scrubbers to reduce the solid input to the washing liquid, but not generally for dry or semi-dry treatment systems where bag filters are used. The bag filters themselves provide a dust control system.

To reduce the release of dioxins to air, the following techniques are used:

- **activated carbon** (or an alternative reagent such as brown coal cokes) is injected before the bag-house filter (67 % of installations)
- a **fixed-bed activated carbon filter** is used (17 % of installations); this can be either a dry or wet system and alternatively brown coal cokes can be used as a reagent
- one installation uses a **Selective Catalytic Reduction (SCR)** specifically to reduce dioxins, as well as other organics and NO<sub>x</sub>.

Installations with very quick quench cooling and no boiler system do not use additional dioxin abatement measures (8 %). The amount of dioxins in the flue-gases is very low due to the fast cooling process. If the flue-gases are fed to an ESP after the quench step, the temperature must be less than 220 °C in order to avoid dioxin reformation.

In order to reduce NO<sub>x</sub> emissions:

- 29 % of the installations use **Selective Catalytic (SCR) or Selective Non Catalytic (SNCR) Reduction** (almost all in Germany)
- three installations use an SNCR, and
- four installation use an SCR.

58 % of installations already comply with the requirement in Directive 2000/76/EC for an ELV of 200 mg/Nm<sup>3</sup> without applying a specific NO<sub>x</sub> abatement technique. The remaining 42 % installations are not currently equipped with a dedicated NO<sub>x</sub> removal system and do not yet comply with this ELV.

### 2.5.11 Flue-gas treatment for sludge incinerators

[2, infomil, 2002] The type of FGT systems used depends largely upon the composition of the waste, and will often be similar to those applied to municipal waste incinerators. However, special attention may be required for removing nitrogen oxides (NO<sub>x</sub>) and mercury.

In two Dutch fluidised bed incineration plants, NO<sub>x</sub> emissions are reduced by the injection of ammonia during the incineration process (SNCR). By using this system, it is possible to reduce a normal emission concentration level of 100 – 200 mg/Nm<sup>3</sup> to less than 70 mg/Nm<sup>3</sup>.

During the sludge incineration process, mercury is mainly released in the metallic state. In municipal waste incineration, due to the larger concentration of chloride in municipal waste mercury is largely in the ionic state (mainly chloride). Metallic mercury is more difficult to remove from the flue-gases than mercury in an ion state. Techniques for the reduction of Hg emissions are described in Section 2.5.6.

## 2.6 Waste water treatment and control techniques

### 2.6.1 Potential sources of waste water

[2, infomil, 2002]

Potential emissions to water from waste incineration plants are as follows:

- **process waste water**

Process waste water generally only arises to any significant degree from wet FGT systems. Other types of flue-gas cleaning systems (dry and semi-dry) do not usually give rise to any effluent. Measures can also be taken with wet systems so that the effluent arising is not discharged from the installation (see later).

- **waste water from collection, treatment and (open air-) storage of bottom ash**

This type of waste water can be used as the water supply for wet de-slaggers, and therefore, normally it will not need to be discharged. It is, however, important to have sufficient storage (and treatment) capacity, in order to be able to cope with fluctuations in storage levels, caused by rainfall. Generally, the treatment options for excess water are: discharge to an available process waste water treatment system; discharge to the local sewerage system; and/or special disposal. This type of waste water can be re-used in the FGT system if the quality is suitable, generally after treatment by sedimentation, filtration etc.

- **other less specific process waste water streams**

For example, waste water from the water/steam cycle (resulting from the preparation of boiler feed-water, boiler drainage, and cooling water discharge). In many practical situations, these water flows can be re-used in the incineration and flue-gas treatment process (e.g. as make-up water) and therefore will not lead to emissions to the environment. However, the recycling of waste water to the FGT system is only possible in the case of semi-wet or wet system if the quality of waste water is suitable; otherwise the waste water is discharged (mainly due to the high salt content).

- **sanitary waste water**

This originates from toilets, kitchens and cleaning. It is normally discharged to the sewerage system, for treatment in a communal waste water treatment plant. A septic tank may be used if there is no other possibility. As this category of waste water is not specific for waste incineration, it is not discussed in this document.

- **clean rainwater**

This arises from rain falling on non-polluted surfaces, such as roofs, service roads and parking places, etc. Normally this water is discharged by a “clean” water collection system and is discharged directly to the local surface water or via soakaways. Pretreatment may be required for rainwater from roads or parking areas.

- **polluted rainwater**

This arises from rain falling on polluted surfaces (unloading activities etc). It is usually segregated from clean water and may be treated before use or discharge.

- **used cooling water**

By far, the largest cooling capacity is required where water condenser cooling is used, i.e. for electricity production with a steam turbine. Depending on the design of the plant, various types of cooling water streams will need to be disposed of.

These include:

- cooling water from convection cooling of the condenser, which is connected with the steam turbine
- cooling water, drained off from an evaporation cooling water system, as used for condenser cooling
- cooling water from various other equipment parts which require cooling (waste chute, hydraulic systems, strippers, etc.).

Because these cooling water streams are not specific for waste incineration, they are discussed in the European “Reference document on the application of Best Available Techniques to Industrial Cooling”.

- **condensed waste water from the partial pre-drying of sewage sludge**

This type of waste water is specific to sewage sludge incineration, although it does not arise in all cases as the steam generated during drying is sometimes evaporated with the incinerator flue-gas instead of being condensed. It generally has a high Chemical Oxygen Demand (COD) and contains substantial concentrations of N (mainly  $\text{NH}_3$ ), as well as other pollutants that were originally present in the treated sludge. The high nitrogen content can form a bottleneck for treatment; in this case stripping of nitrogen may be used, although there may be a risk of fouling and additional energy requirements for its operation. A solution in this case may be recycling into the furnace, when the recovered ammonia-solution (concentration approx. 10 %) can be used for SNCR de- $\text{NO}_x$  feed.

### 2.6.2 Basic design principles for waste water control

[2, infomil, 2002]

The following basic principles are applied to incineration waste water control:

#### 1. Application of optimal incineration technology

Running an optimised incineration process, important in terms of stability of the incineration process, also provides an effective control of emissions to water where wet processes are used (it is not relevant to other processes in respect of water releases because water releases do not generally arise from non-wet processes). Incomplete incineration has a negative effect on the flue-gas and fly ash composition, by increasing the presence of organic compounds with a polluting and/or toxic character. This, in turn, can impact on the content of scrubber effluent.



## 2. Reduction of water consumption and discharge of waste water

Some examples of measures which can be taken to achieve this are:

- maximisation of re-circulation of polluted waste water in wet flue-gas treatment systems (the scrubber), or semi-wet flue-gas treatment systems, including effective control of process parameters, in order to reduce the amount of waste water for discharge
- additional cooling of polluted waste water from wet flue-gas treatment systems (see also condensing scrubbers 2.4.4.5), results in lower water losses to flue-gases and therefore in reduced water consumption. This design can eliminate cooling water consumption.
- application of waste water free flue-gas treatment technology (e.g. semi-dry or dry sorption systems)
- use of boiler drain water as water supply for the scrubber
- treatment of laboratory waste water in the scrubber
- application of waste water free de-slaggers
- use of leachate of open-air bottom ash storage areas for supply of water to the de-slaggers
- direct discharge of clean rainwater from roofs and other clean surfaces
- use of segregated drainage and reduce the exposed surface areas used for waste storage and handling (i.e. roofed enclosures).

## 3. Compliance with relevant water emission standards

Some process options will be greatly effected by local factors. An example of this, is the discharge of salt effluent from scrubbers. While such discharges may be acceptable to marine environments, discharges to fresh watercourses require the consideration of dilution factors etc. Such decisions may, therefore, cause fundamental changes to incineration process design, particularly the FGT system and effluent treatment selection.

## 4. Optimal operation of the water treatment systems

Discharges can only be reduced through the optimal operation of the treatment system.

Having sufficient storage capacity for the buffering of waste water storage, can allow time for operators to react to disturbances in the process conditions.

### 2.6.3 Influence of flue-gas treatment systems on waste water

[2, infomil, 2002]

The production of waste water depends on the selected type of flue-gas treatment system. The following main FGT options are used:

1. dry flue-gas treatment
2. semi-wet flue-gas treatment
3. wet treatment:
  - a) with physical/chemical scrubber effluent treatment
  - b) with in line scrubber effluent evaporation
  - c) with separate scrubber effluent evaporation.

Of these options, only option 3(a) has a waste water stream for discharge. Treatment options for the scrubber effluent from system 3(a) are discussed in the following sections, along with the techniques used to evaporate effluent (options 3b and 3c).

## 2.6.4 Processing of waste water from wet flue-gas treatment systems

The process waste water resulting from wet flue-gas treatment contains a wide variety of polluting components. The amounts of waste water and concentrations depend on the composition of the waste and on the design of the wet flue-gas system. The re-circulation of waste water in wet FGT systems can result in a substantial reduction in the amount of waste water, and as a consequence, in higher concentrations of pollutants.

Three main methods are applied, for treatment of the waste water from wet flue-gas treatment systems:

- **physico-chemical treatment** based on pH-correction and sedimentation. With this system, a treated waste water stream containing dissolved salts is produced, and if not evaporated (see below) requires discharge
- **evaporation in the waste incineration process line** by means of a spray drier, into a semi-wet FGT system, or other system that uses a bag filter. In this case, the dissolved salts are incorporated in the residue of the flue-gas treatment system. There is no emission of waste water, other than that evaporated with the flue-gases (for more detail on in-line evaporation see Section 2.6.4.7.1)
- **separate evaporation** of waste water. In this case, the evaporated water is condensed, but as it is generally very clean can often be discharged (or re-used) without special measures. (for more detail on separate evaporation see Section 2.6.4.7.2).

These are discussed further in the following sections. Some of these techniques are also described in the “Reference Document on Best Available Techniques in the Waste Water and Waste Gas Treatment/Management Systems in the Chemical Sector” (CWW BREF).

If an SNCR is used for NO<sub>x</sub> control with a down stream wet FGT system, NH<sub>3</sub> stripping may be required. [74, TWGComments, 2004]

### 2.6.4.1 Physico-chemical treatment

A typical set-up of a physico-chemical treatment unit for process waste water is given in Figure 2.52 below:

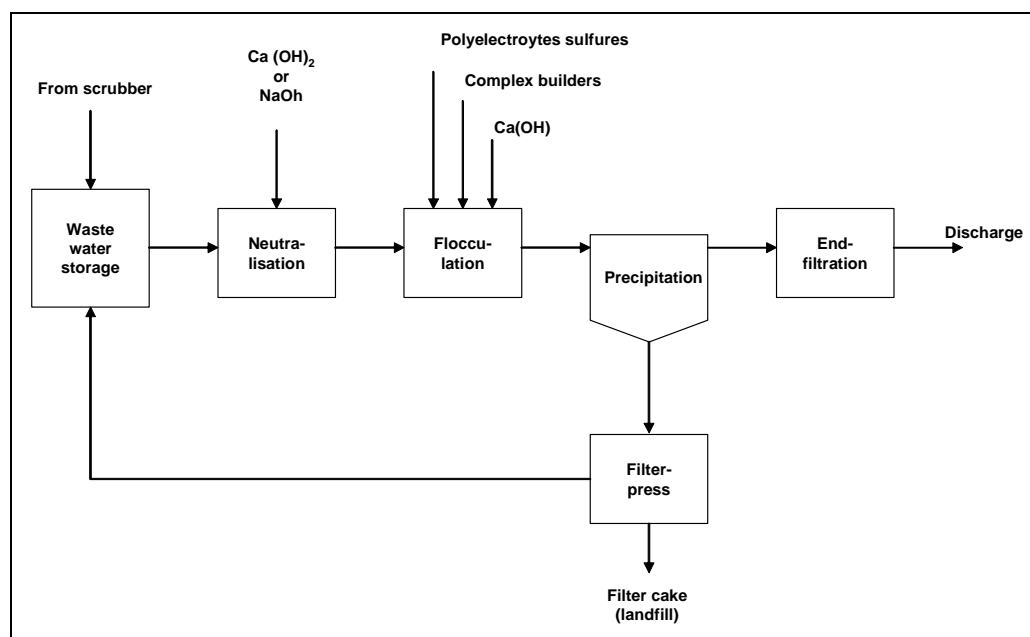

Figure 2.52: Process scheme for physico-chemical treatment of waste water from a wet flue-gas treatment system

Source [2, infomil, 2002]

The process shown consists of the following steps, some or all of these may be in use:

- neutralisation of the polluted waste water
- flocculation of pollutants
- settlement of the formed sludge
- dewatering of the sludge
- filtration of the effluent ('polishing').

Other steps can also be included

- precipitation (e.g. of heavy metals)
- coagulation
- pH and temperature control.

For the neutralisation, lime is often used. This results in the precipitation of sulphites and sulphates (gypsum). Where discharging of sulphites/sulphates to surface water is allowed (e.g. some marine environments), caustic soda (NaOH) can be used instead of lime, resulting in a substantially lower production of filter cake.

Removal of heavy metal compounds is based on flocculation, followed by precipitation. Heavy metal compounds have a very low solubility with a pH range of 9 - 11. Above a pH of 11 heavy metals can re-dissolve again. The optimal pH is different for various heavy metal compounds. In particular, the optimal pH for nickel and cadmium deviates from other heavy metals. Two-step (or more) neutralisation improves the stability and control of discharge acidity (pH). The first step is a coarse neutralisation, especially in the case of waste water from the first acid step of the scrubber system. The second step is a fine neutralisation. The provision of sufficient waste water storage capacity helps to reduce process variations in time, by providing a buffering capacity.

The flocculation of heavy metal hydroxides takes place under the influence of flocculation agents (poly-electrolytes) and  $\text{FeCl}_3$ . The additional removal of mercury and other heavy metals can be achieved if complex-builders are added.

The precipitation of fluorides requires a pH range between 8 and 9. [74, TWGComments, 2004]

Precipitation generally takes place in settling tanks or in lamellar separators.

The resulting sludge is normally dewatered in filter presses. Dry solids contents of 40 – 60 % can be achieved, depending on the chemicals used and on other conditions.

If required, for filtration of the resulting effluent ("polishing"), sand filters and/or active carbon filters can be used. The direct effect of sand filters is mainly a reduction of suspended solids, but this also results in a reduction of heavy metal concentrations. Filtration with active carbon is especially effective for a reduction of PCDD/F-compounds, PAHs, etc. The active carbon needs to be replaced regularly. Other filtration systems are also used (e.g. disc filters).

Physico-chemical waste water treatment units require special operational attention, as they are quite sensitive systems.

#### 2.6.4.2 Application of sulphides

In order to carry out flocculation, organic agents (e.g. polyelectrolytes) are commonly used. The addition of complex-builders and sulphides (e.g.  $\text{Na}_2\text{S}$ , Tri-Mercaptan - TMT, etc.) allow further reductions in mercury and other heavy metal discharges.

The use of sulphides requires special safety regulations, because of their toxicity. One advantage of their use is the lower costs of sulphides in comparison with other complex-builders.

### 2.6.4.3 Application of membrane technology

One option for treatment of waste water polluted with salts and micro-pollutants is membrane-filtration. This technique is especially efficient for large water flows with relatively low salt concentrations. With higher salt concentrations, energy consumption increases rapidly.

The salt content of the process waste water of waste incineration is high (up to 10 w-%). Therefore, this option usually requires significant additional energy consumption.

The remaining water with high solute concentration has to be removed in an appropriate outlet. [74, TWGComments, 2004]

### 2.6.4.4 Stripping of ammonia

For the application of SNCR de-NO<sub>x</sub>, the waste water from the wet scrubber contains ammonia compounds. The actual ammonia concentration depends on the process conditions of the SNCR de-NO<sub>x</sub> unit. Depending on the actual ammonia concentration, stripping of ammonia from the effluent may be an option.

An ammonia-stripping unit consists mainly of a heated distillation column. The vapours are condensed, resulting in an ammonia solution. Though ammonia concentration is normally below the original concentration of the trade product, the solution can be re-used in the SNCR-process.

Stripping of ammonia requires an increase in the pH to 11 - 12.5 and the use of steam. Fouling risks are reported when used with lime neutralisation.

### 2.6.4.5 Separate treatment of waste water from the first and the last steps of the scrubber system

The first step(s) of wet scrubber systems are typically operated at a very low pH-level. Under these process conditions, specifically HCl is removed from the flue-gas stream. The removal of SO<sub>2</sub> takes place in the final step, at a neutral pH.

If these two effluent streams are dealt with separately the waste water treatment process can be optimised for each stream and recyclable gypsum can be recovered from the SO<sub>2</sub> scrubber effluent.

The waste water from the first step of the scrubber is neutralised with lime, followed by removal of heavy metal compounds by normal flocculation and precipitation. The treated waste water, containing mainly CaCl<sub>2</sub> is mixed with the waste water from the final step, mainly containing Na<sub>2</sub>SO<sub>3/4</sub>. This results in the formation of gypsum and a liquid effluent, mainly consisting of NaCl.

Depending on local conditions, this salty waste water is either discharged or evaporated. Evaporation results in the production of NaCl, household salt.

Because the salt is separated from other flue-gas treatment residues contained in the effluent, this results in a very substantial reduction in the mass of residues - the precipitated sludge of heavy metal compounds is the only residue which remains.

### 2.6.4.6 Anaerobic biological treatment (conversion of sulphates into elementary sulphur)

One of the problems with discharging the treated waste water may be the remaining content of sulphates. Sulphates can affect concrete sewerage systems. To solve this problem, a system has been developed for anaerobic biological treatment of waste water from waste incineration.

The sulphates in the waste water can be reduced to sulphides in a reactor, by the activity of anaerobic bacteria. The effluent of this reactor, which has a high content of sulphides, is treated in a second reactor. In this second reactor, the sulphides are biologically oxidised in an aerobic atmosphere into elemental sulphur. Care must be taken to ensure that adequate oxygen is available in the aerobic stage, otherwise thiosulphate will be produced instead of elemental sulphur and this will restrict disposal of the waste water.

Subsequently the sulphur is removed from the waste water in a laminated separator. The collected sludge is dewatered in a decanter, resulting in a sulphur cake, which can be used. The remaining waste water can be re-used in the scrubber and/or discharged.

It is reported that this technology may be difficult to apply in hazardous waste field [64, TWGComments, 2003].

### 2.6.4.7 Evaporation systems for process waste water

If the discharge of soluble salts (chlorides) is not acceptable, the process waste water needs to be evaporated. For this purpose two main options exist:

- in-line evaporation
- separate evaporation.

#### 2.6.4.7.1 In-line evaporation

In this configuration, the waste water is recycled in the process by means of a spray dryer. Figure 2.53 below gives an overview of the process configuration:

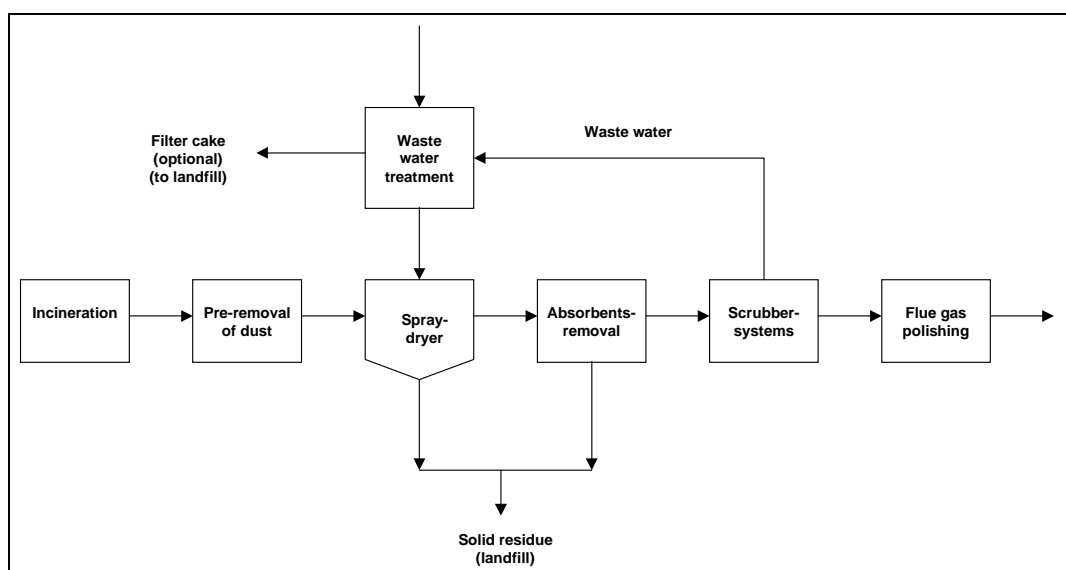

Figure 2.53: In-line evaporation of waste water from wet scrubbing [2, infomil, 2002]

The spray dryer is comparable with the spray absorber, used in the semi-wet FGT system. The difference is that, in the case of semi-wet treatment, lime is injected and, for in-line evaporation, the waste water from the scrubber is used for injection after a neutralisation step. This neutralisation step can be combined with flocculation and the settling of pollutants, resulting in a separate residue (filter cake). In some applications, lime is injected in the spray absorber for gas pre-neutralisation.

The neutralised waste water, containing soluble salts, is injected in the flue-gas stream. The water evaporates and the remaining salts and other solid pollutants are removed in a dust removal step (e.g. ESP or bag filter). This flue-gas treatment residue consists of a mixture of fly ash, salts and heavy metals.

Due to the application of a wet scrubbing system, the consumption of chemicals is approximately stoichiometric and consequently residue production is lower than in semi-dry FGT systems.

### 2.6.4.7.2 Separate evaporation

Separate evaporation is based on evaporation in steam heated evaporation systems. Figure 2.54 below gives an example of a process scheme.

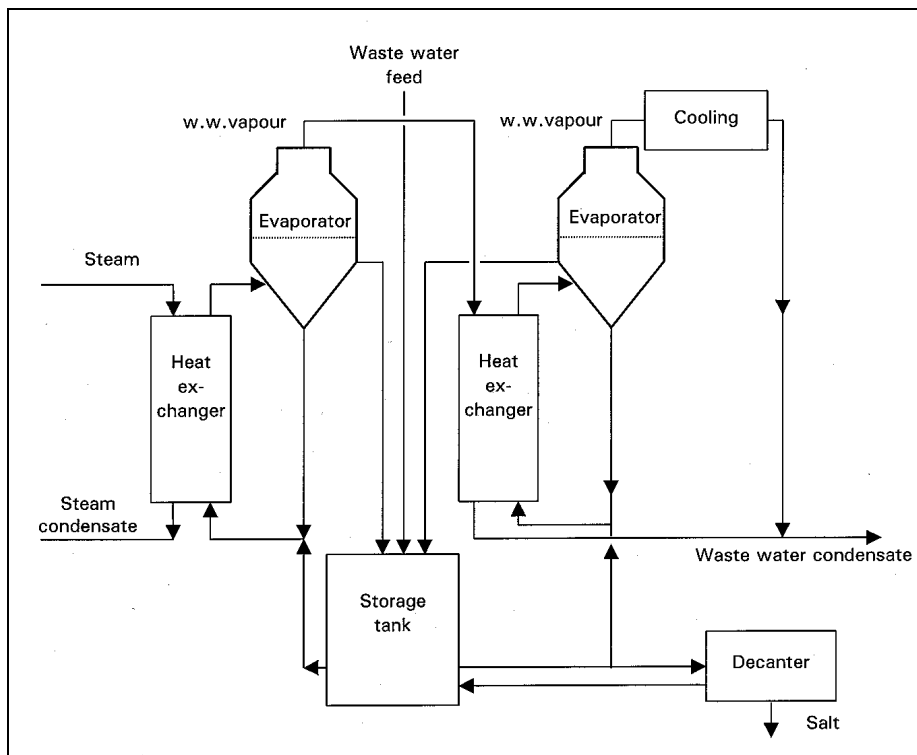

Figure 2.54: Separate evaporation of scrubber effluent from wet scrubbing [2, infomil, 2002]

The waste water, containing soluble salts is fed into a storage tank, containing a mixture of waste water and already partially evaporated liquid. Subsequently, water is partly evaporated in a reactor under low pressure. The required heat is supplied by (low-pressure) steam and transferred to the liquid in a heat-exchanger. The surplus liquid flows back to the storage tank. The vapours are cooled down, resulting in a clean condensate, which is then discharged.

Due to the increasing salt concentrations in the liquid, crystallisation of salts starts. Subsequently, the salt crystals are separated in a decanter and collected in a container.

Figure 2.54 shows a two-stage process, where two evaporators are installed. The input of heat for the second evaporator is from the first evaporator, thus reducing the specific energy consumption. Additionally, if not used for some other purpose (e.g. district heating) the effective energy consumption may be reduced as low-pressure steam can be used.

This technique requires energy and there may be operational risks such as fouling of the crystallisation. [64, TWGComments, 2003]

#### 2.6.4.8 Example of process producing hydrochloric acid with downstream cleaning

[1, UBA, 2001]

When wastes containing chlorine are combusted, hydrogen chloride is formed. Hydrogen chloride is absorbed in water forming hydrochloric acid. The hydrochloric acid produced like this, is a colourless liquid and free of impurities after treatment. It has a concentration of approx. 19 % by weight HCl and can be used as a raw material in different consumer installations, e.g. for pH control in chlorine-producing plants.

In the production of hydrochloric acid, the flue-gases leaving the steam boiler are first discharged into a quench and cooled down. The quench unit lining contains jets through which hydrochloric acid from the downstream washing column is sprayed into the flue-gas. A portion of the hydrochloric acid is then evaporated, which causes the flue-gases to cool down.

The hydrochloric acid is transferred from the quench to the washing column together with the cooled flue-gas. In the washing column hydrogen chloride and other acid gases contained in the flue-gas are absorbed. The hydrochloric acid is then transferred to a temporary storage tank. The flue-gas, now stripped of hydrogen chloride, leaves the acid washing column via a mist eliminator installed at the head of the column and enters the ionisation wet scrubber.

The hydrochloric acid generated in the acid washing column of the flue-gas washing system is stripped of dissolved salts and solids in an evaporator system. This cleaning step can enable the hydrochloric acid to be used as feedstock in a variety of production plants.

From the temporary storage tank, a pump transfers the hydrochloric acid to an evaporator. Here, the raw acid is upgraded in a vacuum to become an azeotropic mixture. The excess water and small amounts of hydrogen chloride pass into the vapour phase and are condensed with water in an adsorption tower.

From the vacuum unit, the process liquid is pumped into the waste water plant together with the excess water. The raw acid, upgraded to an azeotrope, will evaporate, and then condense again. The remaining acid containing solids and heavy metals is drawn from the evaporator and pumped into a mixer for neutralisation purposes.

[64, TWGComments, 2003]

#### 2.6.5 Waste water treatment at hazardous waste incinerators

55 % of European HWI installations do not discharge waste water, they either use systems that do not generate waste water (e.g. dry or semi-dry FGT) or **evaporate** the water via the stack by means of spray dryers or in a separate evaporation plant, sometimes after treating the waste water to remove Hg [74, TWGComments, 2004]

The remaining 45 % of the HWI installations have a **waste water treatment facility**. The current situation is described in Figure 2.55 below and can be summarised as follows:

- a general distinction can be made between the incinerators equipped with a boiler and the other HWI installations equipped with a quick quench-cooling system, with the flow of discharged effluent being greater for the latter due to technical reasons. (Note: some HWI installations are equipped with both a quick quench-cooling and boiler) [74, TWGComments, 2004]. Installations equipped with a boiler discharge between <1 and 5 l/kg incinerated waste. Installations with only quench-cooling systems discharge between 10 and 20 l/kg incinerated waste, although they can reduce their water flow to 5 l/kg by re-circulating the effluent of the waste water treatment plant or recycling within the quench unit itself
- normally the effluents of the acidic section of the wet gas cleaning (containing NaCl, CaCl<sub>2</sub>, Hg, CaF<sub>2</sub> and SO<sub>3</sub>) are mixed with the effluent of the alkaline section (containing Na<sub>2</sub>SO<sub>4</sub>) in order to precipitate part of the gypsum (and to decrease the sulphate content of the effluent to less than 2 g/l, which is the solubility concentration of gypsum) before further treatment. There is, however, one installation where the effluents of acidic and alkali scrubbers are treated separately.

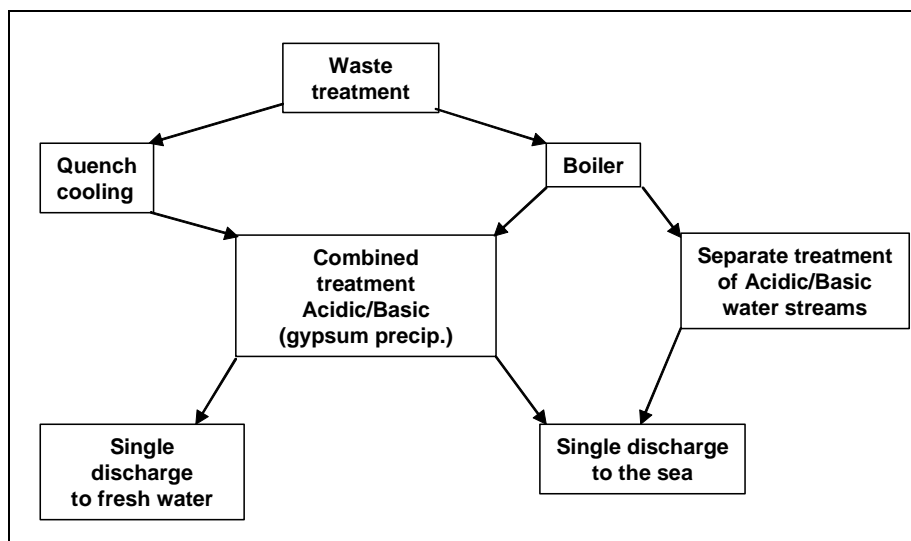

Figure 2.55: Overview of applied waste water treatment systems at merchant HWIs [EURITS, 2002 #41]

Whether an installation has an on-site waste water treatment plant or transfers the waste water to an external treatment plant, depends on its location.

Figure 2.56 below gives a typical set-up of a waste water treatment plant for the treatment of effluents from the wet flue-gas cleaning section from hazardous waste incineration.

The main elements of these facilities are:

- neutralisation (e.g. addition of lime, NaOH/HCl)
- the addition of reagents specifically for the precipitation of metals as hydroxides or metal sulphides (e.g. flocculation agents, tri-mercapto-tri-azine, sulphides, polyelectrolyte)
- the removal of sediment: either using sedimentation by gravity and decantation, or using mechanical techniques such as filter press, centrifuge.

In some waste water treatment plants the waste water is polished by passing it through a **sand filter**, followed by an **activated carbon filter**.



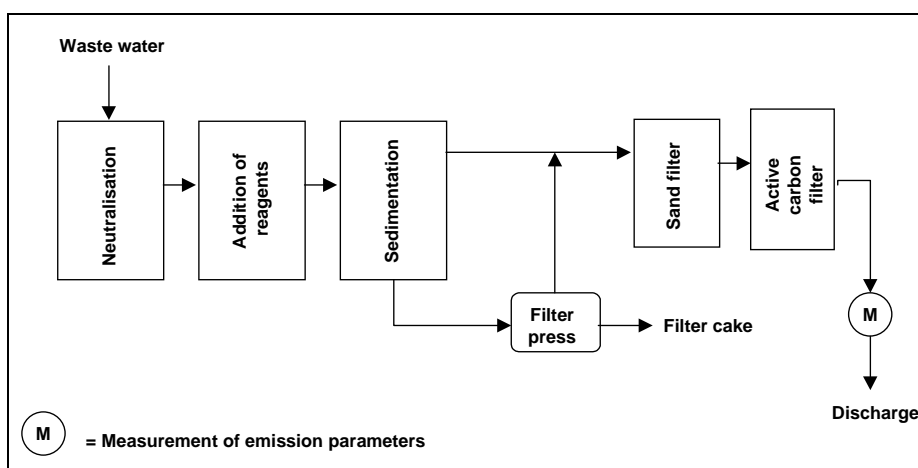

Figure 2.56: Example of a waste water treatment facility in the merchant HWI sector [EURITS, 2002 #41]

## 2.7 Solid residue treatment and control techniques

### 2.7.1 Types of solid residues

Waste incineration results in various types of solid residues, some of which have uses in different countries to varying degrees. A distinction can be made between those residues directly resulting from the incineration process and those resulting from the FGT system. The FGT residues may be fine fly ash and/or reaction products and unreacted additives from the FGT system (or associated waste water treatment system). The latter category is often called Flue-gas Treatment (FGT) or Air Pollution Control (APC) residues. The solid residues from (wet) scrubber effluent treatment processes are often pressed to form a solid called a *filter cake* or mixed with fly ash to minimise volume or for better dewatering with gypsum from the plant. [74, TWGComments, 2004] In addition gypsum and salt may be recovered from wet flue-gas treatment systems if specific processes are used (see below and Section 2.6). [64, TWGComments, 2003]

#### Residues arising from the combustion stage of the incinerator are:

Municipal waste incineration:

- bottom ash, resulting from grate incineration of municipal waste. Because of its large volume, this is an important type of residue, options for its use are discussed in Section 3.4.2
- boiler ash, is collected in the boiler of municipal waste incineration plants and often treated together with fly ash [74, TWGComments, 2004]
- fly ash, is collected in a dust removal step in municipal waste incineration and is discussed further below under FGT residues. This type of waste is generally disposed of, often after pretreatment, but has been used as a filling material for bitumen bound applications in civil construction, in countries where this practise is permitted. [74, TWGComments, 2004] Treatment and disposal are further discussed below.

Hazardous waste and specific clinical waste:

- slag, resulting from rotary kiln incineration of hazardous wastes. In general, this type of residue is disposed of by landfill without further treatment, or may be recycled if locally permitted
- other ashes are similar to those from MSWI but in as they may contain higher levels of pollutants, general the practice has been mostly for their disposal.

Sewage sludge:

- fly ash, resulting from fluidised bed incineration of sewage sludge. This type of waste can be used as a filling material for bound applications in civil construction, in countries where this practice is permitted. It is also used as a filling material for mines in Germany, both applications without further treatment. Fly ash which is not used, is landfilled
- bed ash, resulting from fluidised bed incineration of sewage sludge. This is a relatively small category. It is often added to the fly ash or landfilled without further treatment.

RDF:

- bed ash, resulting from fluidised bed incineration of RDF. Depending on the specific characteristics of the material, bed ash amounts may be substantially higher than for sewage sludge incineration. There is little experience of its re-use
- ash, resulting from small and medium scale incineration of waste wood. This concerns relatively small quantities and is not further discussed.

Some installations operate at especially high temperatures (e.g. >1400 °C) with the specific aim of melting the ash in order to form a slag. Such slags may have improved use options owing to lower leachability etc. High temperature slagging rotary kilns and combined gasification-combustion process provide examples of such systems. The latter is used in Japan, where very strict leachability criteria are applied to MSWI residues, specifically to increase residue re-use and reduce the need for landfill.

Both within and beyond Europe there are variations in policy and procedures regarding the re-use of residues from incinerators. [74, TWGComments, 2004]

### **The second category of residues are the FGT residues:**

FGT residues contain concentrated amounts of pollutants (e.g. hazardous compounds and salts) and therefore normally are not considered appropriate for recycling purposes. The main objective is then to find an environmentally safe final disposal option. The following types of flue-gas treatment residues can be distinguished:

- residues from dry and semi-wet flue-gas treatment. These residue are a mixture of calcium and/or sodium salts, mainly as chlorides and sulphites/sulphates. There are also some fluorides and unreacted reagent chemicals (e.g. lime or sodium carbonate). This mixture also includes some fly ash that has not been removed by any preceding dust removal step. It can, therefore, also include polluting heavy metals and PCDD/F. The normal way of disposal is landfilling as hazardous waste, (e.g. *big-bags*). The leachability of the residues is an important aspect for subsequent landfill disposal, therefore treatments to lower the leachability of these residues prior to landfilling is currently used in Europe (e.g. Austria, the Netherlands, Portugal, France). The FGT residues coming from the dry sodium bicarbonate process can be purified and recycled in an industrial process, e.g. as raw material in the chemical industry; this can require segregation of fly ash and salt residues (e.g. two stages of flue-gas filtration) in order to reduce the inert content. The transport to the end-user can be a critical factor for economics. [74, TWGComments, 2004]
- improvement of the properties for landfilling by cold solidification
- filter cake from the physico/chemical treatment of waste water from wet flue-gas treatment. This material is characterised by a very high heavy metals content, but can also include salts of limited solubility, such as gypsum. The normal way of disposal is landfilling (as hazardous waste). These residues may be concentrated in PCCD/F and are therefore sometimes pretreated before landfilling
- gypsum. Gypsum may also be recovered with or without cleaning depending on the process parameters and quality requirements. Recovery of gypsum is possible when limestone or hydrated lime is used in a two stage wet scrubber with an efficient droplet separator. [74, TWGComments, 2004] The recovered gypsum can be re-cycled in some circumstances

- salts, resulting from in-line evaporation of waste water. This residue is comparable with the residue from (semi-)dry flue-gas treatment
- salts, resulting from separate evaporation of waste water. Salt use or disposal depends on the composition of the residue. It is usually more pure than where in-line evaporation has been carried out
- residues from flue-gas polishing. Options for use depend on the adsorbent used (activated carbon, cokes, lime, sodium bicarbonate, zeolite). The residue of (activated) carbon from fixed bed reactors is sometimes permitted to be incinerated in the waste incineration plant itself, if certain process conditions are fulfilled. The residue of entrained bed systems can also be incinerated, if the applied adsorbent is activated carbon or oven cokes only. If a mixture of other reagents and activated carbon is used, the residue is generally sent for external treatment or disposal, since there might be risks of corrosion. If zeolite is used, there are in principle possibilities to recover the mercury, but these techniques are not yet available in practice. [2, infomil, 2002] [64, TWGComments, 2003]
- use as filler material in salt mines – in some MSs FGT residues of various types are used as fill material in mines.

### 2.7.2 Treatment and re-cycling of solid residues

The high mineral content of incineration ash residues can make them potentially suitable for use as road or other construction material. Use is possible if the material complies with a set of environmental and technical criteria. This requires an optimisation of the ash quality through primary or secondary measures. The general parameters of concern are:

- burn-out
- mineral reactivity
- metal leaching
- salt content
- particle size and particle size distribution.

Residues from many modern waste incineration plants fulfil the environmental and technical requirements for these quality parameters. Regulatory and political barriers sometimes provide the main barriers to the use of (in particular) bottom ashes, from suitably designed/operated installations.

Residue treatment methods generally aim to optimise one or more of these parameters in order to mimic primary construction material quality. Due to its large production volume, lower hazardous character and leachability, treatment for recycling is mainly applied to MSW bottom ash. Bottom ash use is promoted in the Netherlands (>90 % used), Denmark (90 %), Germany (80 %), France (>70 %), Belgium and the UK (21 %). [Vehlow, 2002 #38], [Vrancken, 2001 #39], [56, UKEnvAgency, 2002], [64, TWGComments, 2003], [74, TWGComments, 2004]

Filter and boiler ash treatment is performed in only a few installations in Europe. In The Netherlands fly ash from MSWI and SSI plants is applied as filling material for road construction materials (asphalt) without any pretreatment at the incineration plant. About 1/3rd of the total fly ash from MSWI plants and 80 % of the fly ash from SSI plants (approx. 80000 tonnes total yearly) has been used in this way. [74, TWGComments, 2004]

Primary measures for controlling residue outputs involve optimising control of the combustion process in order to [Vehlow, 2002 #38]:

- guarantee an excellent burn-out of carbon compounds
- promote the volatilisation of heavy metals such as, Hg and Cd out of the fuel bed, and
- fix lithophilic elements in the bottom ash, thus reducing their leachability.

Secondary treatment systems involve one or more of the following actions:

- size reduction, to allow metal segregation and improve technical quality
- segregation of ferrous and non-ferrous metals, which may be recycled in the metals industry
- washing, in order to remove soluble salts
- ageing, to stabilise the matrix structure and reduce the reactivity
- treatment with a hydraulic or hydrocarbon binder, for re-use as road base
- thermal treatment, to make and contain inert metals in a glassy matrix.

Both primary and secondary measures will be discussed in more detail in Section 4.6.

### 2.7.3 Treatments applied to Flue-gas treatment residues

The information in this section is taken from [48, ISWA, 2003]. Further details of the techniques that fall within each of the categories of treatment given below can be found in Section 4.6

#### 2.7.3.1 Solidification and chemical stabilisation of FGT residues

The main purpose of solidification is to produce a material with physical and mechanical properties that promote a reduction in contaminant release from the residue matrix. An addition of cement, for example, generally decreases hydraulic conductivity and porosity of the residue, and, on the other hand increases durability, strength and volume. In addition, it usually increases the alkalinity of the mixture, therefore improving the leaching behaviour of the product, although the solubility of amphoteric metals, such as lead and zinc, may result increased.

The solidified product is usually cast into blocks (e.g. 1 m<sup>3</sup>) or landfilled directly. A major consideration here is to reduce the interaction between the water and the residue. According to Swiss studies, this only influences the leaching behaviour of landfilled products over the first few years of storage.

Solidification methods commonly make use of several, mostly inorganic, binder reagents: cement, lime and other pozzolanic materials such as coal fly ash, blast furnace bottom ash or cement kiln dust, although some organic binders such as bitumen/asphalt or paraffin and polyethylene can also be used. Combinations of binders and various types of proprietary or non-proprietary additives are used as well. The most prevalent solidification technique is by far cement stabilisation.

The main concept of chemical stabilisation is to bind the heavy metals in more insoluble forms than they are present in the original untreated residues. These stabilisation methods make use of both the precipitation of metals in new minerals as well as the binding of metals to minerals by sorption. This process includes the solubilisation of the heavy metals in the residues and a subsequent precipitation in, or sorption to, new minerals.

Several of the stabilisation methods incorporate an initial washing step where a major part of soluble salts and to some extent metals are extracted before chemical binding of the remaining metals. These methods can be completed by dewatering the stabilised product and removal of organic compounds.

[74, TWGComments, 2004]

#### 2.7.3.2 Thermal treatment of FGT residues

The thermal treatment of incineration residues (sometimes FGT and bottom ash are mixed together for treatment) takes place extensively in a few countries, mainly to reduce volume of the residues, but also to reduce its organic and heavy metal content and to improve the leaching behaviour before landfilling. [74, TWGComments, 2004]

Thermal treatment can be grouped into three categories: vitrification, melting and sintering. The differences between these processes are chiefly related to the characteristics and properties of the final product:

- **Vitrification** is a process where residues are treated at high temperature (currently 1300C to 1500 °C and then quickly quenched (with air or water) to obtain an amorphous glassy matrix. After cooling down, the melt forms a single phase product called a vitrificate. The vitrificate can be a glass like or stone-like product depending on the melt composition. Additives are sometimes added to the residues to favour the formation of the glassy matrix [64, TWGComments, 2003]
- **Melting** is similar to vitrifying, but the quenching step is controlled to allow crystallisation of the melt as much as possible. It results in a multi-phase product. Temperatures and the possible separations of specific metal phases are similar to those used in vitrifying. It is also possible to add specific additives to favour the crystallisation of the matrix. [64, TWGComments, 2003]
- **Sintering** involves the heating of residues to a level where bonding of particles occurs and the chemical phases in the residues reconfigure. This leads to a denser product with less porosity and a higher strength than the original product. Typical temperatures are around 900 °C. When MSW is incinerated, some level of sintering will typically take place in the incineration furnace. This is especially the case if a rotary kiln is used as part of the incineration process.

Regardless of the actual process, the thermal treatment of residues in most cases results in a more homogeneous, denser product with improved leaching properties. Vitrifying also adds the benefits of physical containment of contaminants in the glass matrix.

The energy requirements of stand alone treatments of this type, are generally very high. The main problem is the heat transport into the melting reactor. [74, TWGComments, 2004] In some cases residue melting is achieved within the installation (i.e. not in a separate melting process) using a higher temperature combustion stage (see 2.3.4.4.3). In such cases the energy demand is partially met by the use of the flue-gas thermal energy and external energy input requirements may be reduced.

The flue-gas issued from thermal treatment of solid residues may contains high levels of pollutants such as NO<sub>x</sub>, TOC, SO<sub>x</sub>, dust and heavy metals etc. Therefore appropriate flue-gas treatment is required. Sometimes the flue-gas produced is fed into the FGT of the incinerator if nearby. [74, TWGComments, 2004]

The high salt concentrations in FGT residues can cause corrosion problems in the flue-gas treatment from such processes. Sintering is not used as a dedicated treatment option for FGT residues, although some combined treatments do involve this.

### 2.7.3.3 Extraction and separation of FGT residues

Treatment options using extraction and separation processes can, in principle, cover all types of processes extracting specific components from the residues. However, most emphasis has been put on processes involving an extraction of heavy metals and salts with acid.

Several techniques have been proposed both in Europe and in Japan. Most of these techniques make use of the acidic solution from the first scrubber in wet FGT systems.

### 2.7.3.4 Chemical stabilisation of FGT residues

The main concept of chemical stabilisation is to bind the heavy metals in more insoluble forms than they are present in the original untreated residues. These stabilisation methods make use of both the precipitation of metals in new minerals as well as the binding of metals to minerals by sorption. This process includes the solubilisation of the heavy metals in the residues and a subsequent precipitation in, or sorption to, new minerals.

Several of the stabilisation methods incorporate an initial washing step where a major part of soluble salts and to some extent metals are extracted before chemical binding of the remaining metals. These methods are completed by dewatering the stabilised product.

### 2.7.3.5 Other methods or practices for FGT residues

A commonly used management option at incinerators with wet cleaning systems is to combine the fly ash with the sludge produced by treating the scrubber solutions; the resulting product is called a *Bamberg cake*. Sulphides in the sludge used in the waste water treatment facility to precipitate heavy metals can further help decrease leachability of heavy metals from the Bamberg cake in a landfill. This method has been used for more than a decade to improve residue properties before landfilling.

It is also possible to contact the fly ash with the acidic waters of a scrubber. It is reported that this can achieve very significant extraction of the heavy metal and organic components. [74, TWGComments, 2004]

## 2.8 Monitoring and control techniques

### 2.8.1 Incineration control systems

[2, infomil, 2002]

One of the main challenges with waste incineration results from the often wide variation in waste composition, including differences in some properties that have a significant effect on the incineration process. Because of these wide differences, incineration processes have been developed to cope with large variations in process conditions. However, when unfavourable process conditions occur, interventions in the operation are still required.

The introduction of sophisticated control systems is, therefore, an important development. These systems result in an incineration process that has less variations in time (improved stability) and space (more homogeneous). The improved process control has many potential advantages, such as (note: the main reason(s) for the improvement are given in parentheses):

- better bottom ash quality (due to sufficient primary air distribution and a better positioning of the incineration process on the grate)
- less fly ash production (due to less variations in the amount of primary incineration air)
- better fly ash quality (less unburned material, due to more stable process conditions in the furnace)
- less CO and C<sub>x</sub>H<sub>y</sub>-formation (due to more stable process conditions in the furnace; i.e. no 'cold' spots)
- less NO<sub>x</sub> formation (due to more stable process conditions in the furnace; i.e. no 'hot' spots)
- better utilisation of the capacity (because the loss of thermal capacity by variations is reduced)
- better energy efficiency (because the average amount of incineration air is reduced)
- better boiler operation (because the temperature is more stable, there are less temperature 'peaks' and thus less risk of corrosion and clogging fly ash formations)
- better operation of the flue-gas treatment system (because the amount and the composition of the flue-gases is more stable)
- the indicated advantages also result in less maintenance and better plant availability.

In order to be able to control the incineration process, detailed process information is required, a control system ('philosophy') must be designed, and it is necessary to be able to intervene in the process. Design of the overall control system depends on the specific grate and furnace design of each supplier. Therefore, this section only provides an overview of potential process information, control philosophy systems and process interventions.

Process information may include:

- grate temperatures for various positions
- thickness of waste layer on the grate
- pressure drop over the grate
- furnace and flue-gas temperatures at various positions
- determination of temperature distribution over the grate surface by optic or infrared measurement systems
- CO-, O<sub>2</sub>-, CO<sub>2</sub>- and/or H<sub>2</sub>O-measurements (at various positions)
- steam production.

The control philosophy may be a classic control system, which is part of the process control computer. Additionally, fuzzy control systems are applicable.

Control interventions include:

- the dosing system for the waste
- frequencies and speed of grate movements in various parts of the grate
- amount and distribution of primary air at the various grate compartments
- temperature of the primary air (if preheating facilities are available)
- amount and distribution of secondary air in the furnace (and, if available, of re-circulated flue-gas).

## 2.8.2 Overview of emissions monitoring carried out

General information on emissions monitoring is presented in the BREF "Reference Document on the General Principles of Monitoring" (MON code).

[1, UBA, 2001]

The recent EU directive (2000/76/EC) on the incineration of waste includes requirements for emissions measurement.

The following emission compounds are to be measured on a continuous basis:

- dust
- HCl
- SO<sub>2</sub>
- CO
- C<sub>x</sub>H<sub>y</sub>
- NO<sub>x</sub> (if emission standards apply)
- HF (but not if the process ensures adequate HCl- removal).

Continuous measurements are not imperative for HCl, HF and SO<sub>2</sub>, where the process is such that it is not possible that emission standards to be exceeded (Art.11 (6) of EU Directive 2000/76/EC).

Additionally, the following process parameters need to be monitored continuously:

- furnace temperature
- O<sub>2</sub>
- pressure
- flue-gas outlet temperature
- water vapour content (unless emission measurements are executed in dried flue-gas).

Other emission compounds to be measured on a regular base (minimum of 2 – 4 times per year) are:

- heavy metals
- PCDD/F.

Measurement techniques for Mercury (Hg) and dioxins (PCDD/F's) are relatively complicated and expensive.

Measurements of mercury are more complicated than measurements of other heavy metals, as a substantial part of the emitted mercury is in the gaseous state. Some analysers measure only elemental mercury, and others can measure total mercury (e.g. ionic and elemental mercury). In the last decade, measurement systems for mercury have become more sophisticated. Older measurements were often unreliable, as the gaseous part of the mercury emission was neglected. Continuous measurement of Hg has proven to be a reliable method within certain borders and it is prescribed in some national legislations (e.g. in Germany and in Austria).

While there is not currently a continuous measurement system for dioxins. However, a continuous sampling system is available. This system is operational in some waste incineration plants in Austria and Belgium and has been operated for six months in a Dutch hazardous waste incineration plant. Samples can be analysed as frequent as necessary or desirable.

In some cases actual impacts of the emissions may be assessed by bio-monitoring (e.g. with lichen). Although it may be difficult to attribute impacts to individual sources, such monitoring may make a useful contribution in respect of the assessment of combined impacts where there are multiple sources.

[74, TWGComments, 2004]

### 2.8.3 Experiences with continuous sampling of dioxin emissions

(Belgium 2002)

According to the EN1948 standard, dioxin emissions from waste incinerators are sampled during 6 to 8 hours. This measurement is generally carried out once or twice a year, although at much greater frequencies in some cases.

Continuous sampling has proven to be useful for the assessment of dioxin emissions during unfavourable process conditions. The technique has been used to demonstrate low PCDD/F emissions over the entire range of operational conditions. The results can also be used to guide technological improvements, revised monitoring requirements, or other changes.

Cost data for continuous sampling of dioxins (from Indaver):

Investment:	EUR 110000 - 140000
Testing of the system:	EUR 4900 (estimation)
Analysis (26 samples/yr):	EUR 20000/yr
Maintenance by the supplier (preventive):	EUR 2500/yr



## 2.8.4 Experiences with continuous measurement of mercury emissions

Continuous measurement and recording of emissions of mercury and its compounds has been required by law for waste incineration installations in Germany since 1999, except those installations where it can be reliably proven that mercury levels are less than 20 % of the defined limits.

Continuous monitoring of a HWI is also reported to have been carried out since 1992 using a reduction unit and cold vapour instrument.

The standard reference method for comparative measurements during calibration is the potassium permanganate method in accordance with EN 13211. It should be noted that this method determines the total mercury content (i.e. metallic/elemental Hg + ionic Hg), while some Hg analysers only detect the proportion of metallic mercury.

During the test, the instrument is calibrated using test gases. The test gases must be produced immediately before being used (e.g. by setting the required gas pressure in the gas phase over a mercury reactor). When using test gas, it may be necessary to take the cycle time of the measuring device into consideration. In the same way, the sampling interval for the comparative measurements must be adjusted to the enrichment phase for the measurement device.

Examples of suitability-tested continuous working measuring devices for emission measurements of mercury are listed in the table below:

Suitable measurement devices	Manufacturer/Distribution	Announcement in the GMBI		
		Year	No.	Page
Type	Manufacturer/Distribution	Year	No.	Page
OP SIS AR 602 Z	OP SIS AB	1994	289	869
		1996	42	882
HG MAT II	Seefelder Messtechnik	1995	7	101
HGMAT 2.1	Seefelder Messtechnik	1998	20	418
HM 1400	VEREWA	1996	28	592
HG 2000	SEMTECH AB	1996	28	592
MERCEM	Bodenseewerk Perkin-Elmer	1996	28	592
SM 3 Quecksilbermonitor	Mercury Instrument und IMT Innovative Messtechnik	1999	33	720
Hg 2010	SEMTECH AB	2000	60	1193
Hg-CEM	Seefelder Messtechnik	2000	60	1193
HM 1400 TR	VEREWA	2001	19	386
MERCEM	SICK UPA	2001	19	386

**Table 2.18: Tested continuous working measuring devices for emission measurements of mercury [64, TWGComments, 2003]**

Cost data for continuous measurement of mercury (estimated):

Investment: EUR 30000

Testing of system: EUR 5000

## 2.8.5 Overview of safety devices and measures

This section deals with safety in the sense of preventing accidents that could give rise to pollutant emissions.

[64, TWGComments, 2003]

Plant safety is an important aspect in the planning, establishment and operation of waste incineration plants. To ensure a high level of plant safety and operational safety, the safety-relevant parts of the installation are equipped with protective systems. These are to prevent, as far as possible, the occurrence of malfunctions or accidents with the potential to cause negative effects on the environment in the vicinity of the plant, or to reduce such effects if a malfunction or accident occurs.

Safety-relevant parts of waste incineration plants and, therefore, potential sources of danger include, in particular areas in which certain substances are present or can be formed in safety-relevant quantities.

These are, in particular:

- the waste bunker and other areas for the storage of potentially hazardous waste
- the combustion and flue-gas purification plants, and
- storage facilities for necessary auxiliaries (e.g. ammonia, activated carbon, etc.).

Protective systems used to control risks include:

- systems for controlling the release of pollutants, such as retention systems for used fire-fighting water, bunding of tanks for substances constituting a hazard to water
- fire protection systems and devices such as fire walls, fire detectors, fire extinguishing systems
- systems for protection against explosions, such as pressure relief systems, bypasses, arrangements for avoiding sources of ignition, inert gas systems, earthing systems etc.
- systems for protection against sabotage (e.g. building security, access control and surveillance measures)
- systems for protection against lightning strike
- fire dividing walls to separate the transformers and retention devices
- fire detection and protection where low voltage power distribution panels are located
- pollutant detection (ammonia, gas etc.) near corresponding storage, distribution etc.

Other plant components required for operational safety:

- machines and equipment designed to ensure input and output of energy (e.g. emergency power generator)
- components for the discharge, removal or retention of hazardous substances or mixtures of hazardous substances, such as holding tanks, emergency relief and emptying systems
- warning, alarm and safety systems, which trigger when there is a disruption of normal operations, prevent a disruption of normal operations or restore normal operations. This includes all instrumentation and control systems of a plant. In particular, it includes all instrumentation and control systems for the various process parameters which are essential to secure normal operations, on the one hand, and which, in the event of a disturbance bring the affected plant components to a safe condition and inform the operating personnel of the disturbance in good time, on the other.

The response of a protective device to a malfunction or an accident may cause a temporary increase in pollutant emissions. The aim of all safety measures must be to keep this time span to a minimum and to restore the safety of the plant.

[64, TWGComments, 2003]

## 3 EMISSIONS AND CONSUMPTIONS

### 3.1 Introduction

Emissions and consumptions at waste incinerators are mainly influenced by:

- waste composition and content
- furnace technical measures (design and operation)
- design and operation of flue-gas cleaning equipment.

#### **Emissions to air:**

Emissions of HCl, HF, SO<sub>2</sub>, NO<sub>x</sub>, and heavy metals depend mainly on the structure of the waste and the flue-gas cleaning quality. CO and VOC emissions are determined primarily by furnace technical parameters and the degree of waste heterogeneity when it reaches the combustion stage. The furnace design and operation to a large extent also effect NO<sub>x</sub>. Dust emissions are very dependent upon flue-gas treatment performance. PCDD/PCDF emissions to air depend on waste structure, furnace (temperature and residence times) and plant operating conditions (reformation and *de-novo* synthesis are possible under certain conditions) and flue-gas cleaning performance.

Municipal waste incineration plants generally produce flue-gas volumes (at 11 % oxygen) of between 4500 and 6000 m<sup>3</sup> per tonne of waste. For hazardous waste incineration plants, this value (at 11 % oxygen) is generally between 6500 and 10000 m<sup>3</sup>, depending mainly on the average thermal value of the waste. Plants using pyrolysis, gasification or oxygen enriched air supply results in lower flue-gas volumes per tonne of waste incinerated.

The emission levels to air noted in this document are reported over specified averaging periods – usually annual, daily and half-hourly averages. Some installations, particularly those that treat highly heterogeneous wastes, may experience transient conditions that give rise to instantaneous emission concentrations that are outside of the numerical range of the averaged levels. [64, TWGComments, 2003]

#### **Emissions to water:**

Depending on the type of flue-gas cleaning applied, emissions into the medium water may also occur. Wet flue-gas cleaning is the main source of effluents, although in some cases this effluent is also eliminated by evaporation.

Some other waste water streams may arise from storage, boilers etc. These have already been described in Section 2.6.1.

#### **Solid residues:**

Solid residues that may arise are:

- bottom ash or slag – mainly the incombustible fraction of the waste
- boiler ash – the ash that accumulates and is removed from the boiler
- fly ash – the light ash that travels with the flue-gas and is then removed by FGT equipment
- air pollution control residues accumulated, reacted and un-reacted that are accumulated in the FGT equipment
- waste water treatment residues.

[64, TWGComments, 2003]

The production and content of these solid residues is influenced by:

- waste content and composition, e.g. different ash contents vary the amount of bottom ash arising, or different substances that will end up in flue-gas cleaning residues
- furnace design and operation, e.g. pyrolysis plants deliberately produce a char in place of the ash, and higher temperature furnaces may sinter or vitrify the ash and volatilise some fractions
- flue-gas treatment design and operation, e.g. some systems separate dusts from chemical residues, wet systems produce an effluent for treatment to extract solids.

### **Energy output from the installation:**

The major influences on the achieved export levels are:

- availability of an energy user (particularly for heat/steam supply)
- installation design (particularly for electrical output where the steam parameters chosen for electrical generation have a significant influence on electrical generation rates).

The energy output system design adopted is often heavily influenced by the income to be derived from the sales of the energy supplied. Relative and absolute prices of heat, steam and electricity all have an influence the final design and hence the energy output and efficiency levels achieved.

### **Energy consumption by the installation itself:**

Main influences are:

- the waste composition - some wastes require the addition of fuels to assist their treatment others are auto thermal i.e. they generate sufficient heat to support the combustion without additional fuel input
- the design of the installation e.g. varying energy requirements of different flue-gas treatment equipment designs in general, the lower the required emissions to air the higher the energy consumption by FGT.

### **Other consumptions:**

The consumption of chemical reagents is mainly associated with the design and operation of flue-gas cleaning equipment - which, to a large degree, is dependent upon waste type and the desired air emission levels – lower air emissions generally require higher reagent dosing rates.

### **3.1.1 Substance partitioning in waste incineration**

[1, UBA, 2001]

As a result of their chemical properties, the different elements contained in the waste are distributed differently in the incineration process. Table 3.1 gives an example of this distribution on the basis of Austrian examinations at the waste incineration plant of Spittelau, Vienna.

This distribution varies from plant to plant, depending on the flue-gas cleaning method used, waste type and other factors, but these figures provide a guide to the percentage distribution of various substances in a MSWI. The installation concerned uses an ESP as a pre-deduster, before wet FGT, with an ETP treating the scrubber effluent:

Substance	Cleaned flue-gas discharge	ESP dust	Waste water	Filter cake from waste water treatment	Bottom ash <sup>2,3</sup>
Carbon %	98 (+/-2)	<1	<1	<1	1.5 (+/-0.2)
Chlorine %	<1	35	54	<1	11
Fluorine %	<1	15 (+/-1)	<1	<1	84 (+/-1)
Sulphur %	<1	38 (+/-6)	8 (+/-1)	6 (+/-1)	47 (+/-7)
Phosphor %	<1	17 (+/-1)	<1	<1	83 (+/-1)
Iron <sup>1</sup> %	<1	1 (+/-0.5)	<1	<1	18 (+/-2)
Copper %	<1	6 (+/-1)	<1	<1	94 (+/-1)
Lead %	<1	28 (+/-5)	<1	<1	72 (+/-5)
Zinc %	<1	54 (+/-3)	<1	<1	46 (+/-3)
Cadmium %	<1	90 (+/-2)	<1	<1	9 (+/-1)
Mercury %	<1	30 (+/-3)	<1	65 (+/-5)	5 (+/-1)

Note:

- the remaining approx. 80 % are sorted out as scrap
- the bio-availability of materials that remain in the bottom ash depends on leachability in-situ during subsequent use/disposal
- the risk associated with the re-use of bottom ash is not necessarily indicated by the presence or absence of the substances indicated – the chemical and physical form of the substance as well as the nature of the environment where the material will be used is also important. [64, TWGComments, 2003]

**Table 3.1: Distribution of various substances in an example MSWI installation (in mass %) [1, UBA, 2001, 64, TWGComments, 2003]**

Additional differences result from different contents of waste, especially in the case of hazardous waste incineration facilities.

Table 3.2 gives the percentage distribution of six heavy metals, Hg, Cd, As, Pb, Cu and Zn, averaged over a test period in a HWI. The table also gives the mass fraction of the following solid residues: slag, fly ash and filter-cake, related to the amount of waste incinerated during the test.

Heavy metal	Solid residues for disposal				Act. carbon	Release to environment				
	Slag	Fly ash	Filter-cake	Sum		To air	Water effluent	Water landfill	To land	Sum
% Mass fraction	30	3	4							
Hg	<0.01	<0.01	99.88	99.88	0.05	<0.01	0.07	0	0	0.07
Cd	1.3	94.2	4.49	99.99	<0.01	<0.01	<0.01	0	0	<0.01
As	14.6	80.0	5.39	99.99	<0.01	<0.01	<0.01	0	0	<0.01
Pb	41.2	56.0	2.75	99.95	<0.01	0.03	0.02	0	0	0.05
Cu	75.9	22.4	1.69	99.99	<0.01	<0.01	0.01	0	0	0.01
Zn	41.9	56.9	1.17	99.97	<0.01	0.01	0.02	0	0	0.03

**Table 3.2: Percentage (%) distribution of heavy metals in a hazardous waste incineration process [41, EURITS, 2002]**

The most important parameters that influence the behaviour of metals are:

- kiln temperature
- O<sub>2</sub> excess in the kiln
- the chlorine and sulphur contents of the waste and
- the mass transfer of fine particles in the flue-gas.

The average conditions during the tests on a HWI that gave rise to the data in Table 3.2 are given below in Table 3.3.

Parameter	Test data
Kiln temperature	1120 ± 40 °C
PCC temperature	1100 ± 20 °C
Oxygen content (in the kiln)	11.9 ± 1.3 %
Cl-content (in the waste)	5.1 ± 1.0 %
S-content (in the waste)	1.0 ± 0.2 %

**Table 3.3: Average operational conditions during partitioning tests on a HWI installation [41, EURITS, 2002]**

From Table 3.2 the following observations regarding the metals studied can be made:

- about 99.6 % of the pollutants are concentrated in the solid residues
- about 70 – 80 % of the pollutants are concentrated and immobilised in the fly ash and filter-cake fraction; both residues amount in weight to approximately 7 % of the original waste input
- the removal of Hg from the flue-gas is (in this case) mainly the result of the low pH of the first gas-cleaning stage.

### 3.1.2 Examples of the dioxin balance for MSWI

[1, UBA, 2001]

PCDD/PCDF is contained in the input (municipal waste) as well as the output (outgoing air, waste water and residues) of municipal waste incineration plants. Most of the PCDD/PCDF input is destroyed during the incineration process but it can also be reformed.

The balance below is for a typical plant in Germany, operating free of process water releases and complying with German emission limit values:

Output streams	Amount per kg of waste input	Specific load	Specific account stream per kg of waste input
Flue-gas	6.0 m <sup>3</sup>	0.08 ng/m <sup>3</sup>	0.48 ng/kg
Bottom ash	0.25 kg	7.0 ng/kg	1.75 ng/kg
Waste water	0	n/a	0
Filter dust and other residues from flue-gas cleaning	0.07 kg	220 ng/kg	15.40 ng/kg
<b>Total output to all media:</b>	17.63 ng TEQ/kg of waste.		
Note: Estimated input with the waste: 50 ng TEQ/kg of waste			

**Table 3.4: PCDD/PCDF balance for a municipal waste incineration plant in Germany [1, UBA, 2001], [64, TWGComments, 2003]**

From Table 3.4 above it can be seen that, for the example given, the estimated output released to air is approx. 1 % of the input (0.48 ng TEQ/kg out of 50 ng TEQ/kg). The estimated output released to all media is 17.63 ng TEQ/kg of incoming waste. This corresponds to 35.3 % of the estimated input (i.e. a net destruction of 64.7 % of the PCDD/F originally contained in the waste). It can therefore be concluded that, in this case, the installation acts as a net sink for PCDD/F. [64, TWGComments, 2003]

Other data from a 1997 study (French Ministry of Environment/TIRU) of 8 MSWI and 2 HWI showed significant variation in residue PCDD/F content:

- bottom ash: 0.3 - 300 ng I-TEQ/kg
- boiler ash: 40 - 700 ng I-TEQ/kg
- fly ash: 60 - 5000 ng I-TEQ/kg
- filter cake (wet FGT): 600 - 30000 ng I-TEQ/kg
- semi-wet FGT residues: 800 ng I-TEQ/kg (approx.).

Where data shows variation to the extent indicated in the bullets above, it is more difficult to draw conclusions regarding the overall mass balance of PCDD/F.

[64, TWGComments, 2003]

The following data is an example of an MSWI (in France) operating with a release to water:

Output stream	Specific Load
Flue-gas	0.1 ng I-TEQ/Nm <sup>3</sup>
Bottom ash	7 ng I-TEQ/kg
FGT residues	5200 ng I-TEQ/kg
Waste water	<0.3 ng I-TEQ/l
Note: Example given is for a MSWI with FGT of ESP + wet scrubber (2 stage) + SCR	

**Table 3.5: Example PCDD/F load data for an MSWI in France**  
[64, TWGComments, 2003]

### 3.1.3 Composition of crude flue-gas in waste incineration plants

The composition of crude flue-gas in waste incineration plants depends on the structure of the waste and on furnace-technical parameters.

Table 3.6 provides an overview of typical crude flue-gas concentrations after the boiler and before the flue-gas treatment.

Components	Units	Incineration plants for		
		Municipal waste	Hazardous waste	Industrial sewage sludge (fluidised bed)
Dust	mg/Nm <sup>3</sup>	1000 – 5000	1000 – 10000	30000 – 200000
Carbon monoxide (CO)	mg/Nm <sup>3</sup>	5 – 50	<30	5 – 50
TOC	mg/Nm <sup>3</sup>	1 – 10	1 – 10	1 – 10
PCDD/PCDF	ngTEQ/ Nm <sup>3</sup>	0.5 – 10	0.5 – 10	0.1 – 10
Mercury	mg/Nm <sup>3</sup>	0.05 – 0.5	0.05 – 3	0.2
Cadmium + thallium	mg/Nm <sup>3</sup>	<3	<5	2.5
Other heavy metals (Pb, Sb, As, Cr, Co, Cu, Mn, Ni, V, Sn)	mg/Nm <sup>3</sup>	<50	<100	800
Inorganic chlorine compounds (as HCl)	mg/Nm <sup>3</sup>	500– 2000	3000 – 100000	
Inorganic fluorine compounds (as HF)	mg/Nm <sup>2</sup>	5 – 20	50 – 550	
Sulphur compounds, total of SO <sub>2</sub> /SO <sub>3</sub> , counted as SO <sub>2</sub>	mg/Nm <sup>3</sup>	200 – 1000	1500 – 50000	
Nitrogen oxides, counted as NO <sub>2</sub>	mg/Nm <sup>3</sup>	250 – 500	100 – 1500	<200
Nitrous oxide	mg/Nm <sup>3</sup>	<40	<20	10 – 150
CO <sub>2</sub>	%	5 – 10	5 – 8	
Water steam (H <sub>2</sub> O)	%	10 – 20	6 – 20	
Notes:				
1. Sewage sludge plants are those for the incineration of industrial sewage sludge				
2. The information in this table refers to German plants. The values seen at older plants can be considerably higher, especially in the case of emissions influenced by furnace-technical parameters e.g. CO, TOC, etc.				
3. Hazardous waste values refer to mixed HW merchant plants rather than dedicated stream plants.				

**Table 3.6: Flue-gas concentrations after the boiler (crude flue-gas) at various waste incineration plants (O<sub>2</sub> reference value 11 %)**  
[1, UBA, 2001], [64, TWGComments, 2003]

#### Municipal waste:

In the case of municipal waste, the structure depends, among other things, on the systems used for the collection of different waste fractions and on the use or absence of pretreatment. For example, the separate collection of different municipal waste fractions can influence the thermal value of municipal waste in the following way:

- glass and metal - reduction of the ash content, resulting in an increase in the thermal value
- paper - reduction of the thermal value
- light packaging - reduction of the thermal value
- clinical/hospital waste - increase in the thermal value.

Parameters such as the chlorine content and heavy metals content are also influenced, but the changes remain within the typical range of variations. The provision of separate collections of various fractions of household waste can have a significant influence over the average composition of the waste received at MSWIs. For example, separate collection of some batteries and dental amalgam can significantly reduce mercury inputs to the incineration plant. [64, TWGComments, 2003]

#### Commercial non-hazardous waste:

In the case of non-hazardous waste from commercial enterprises, the ranges of variations can be considerably greater than MSW. When incinerated with other MSW, mixing in the bunker and shredding may be used to limit these variations.



Hazardous waste:

The composition of hazardous waste may vary within a considerably greater range. In the case of hazardous waste, fluorine, bromine, iodine and silicon can be significant. Unlike municipal waste, however, the structure of hazardous waste is usually verified at the incineration plants by means of a check analysis of all essential parameters. Due to the possible variations, a hazardous waste incineration plant is designed with regard to an average waste structure (menu), in some cases with considerable additional reserves for flue-gas cleaning.

Such an incineration menu can then be created by intentionally mixing the incoming waste in bulk tanks or the bunker, or by individually feeding the waste to the furnace in separate pipes in hourly amounts corresponding to the design of the plant. This is also taken into account if waste is fed in barrels, which can themselves exert sudden shock loads. Incineration plants specifically designed for recovering HCl and SO<sub>2</sub> from waste streams containing chlorine or sulphur, respectively, may have very different raw gas structures.

Sewage Sludge:

[64, TWGComments, 2003]

Variations in the raw gas at sewage sludge incineration plants correspond to changes in the waste composition of the incinerated waste. This, in turn, is influenced by the presence or absence of pretreatment, and the composition of the sludge received. The composition of sewage sludge is strongly dependent upon the nature of the drainage catchment served by the sewage treatment works (STW) where the sludge arises, and the treatments applied at the STW.

Where sewage sludge is incinerated with other wastes, variations in sewage sludge quality may have a less pronounced effect on raw gas quality owing to the buffering effect of the other wastes. The water content of the sewage sludge may indeed provide benefits at some MSWI installations as when sprayed through special nozzles in selected locations above the waste bed (often in the gas burnout zone) it provides an additional means of controlling temperature and may assist with primary NO<sub>x</sub> control.

Clinical waste:

[64, TWGComments, 2003]

Variations in the raw gas at clinical incineration plants correspond mainly to changes in the waste composition of the incinerated waste. Physical pretreatment that may limit the range of variation of raw gas composition are not often used for clinical wastes because of concerns regarding the infectivity of the waste.

Categorising incoming waste streams according to their source and probable combustion characteristics (mainly relating to CV, moisture content and calorimetric throughput rate) and feeding them to the incineration process so as to comply with an appropriate input *recipe*, may be used to reduce the range combustion related raw gas composition variations.

### 3.1.4 Emissions of gases relevant to climate change

#### Sources and total emissions relevant to climate change

The total emissions relevant to climate change in Germany in the year 1999 and the emissions from waste incineration (related to the fossil portion of the waste that is considered relevant to climate change in Germany) are summarised in Table 3.7:

Pollutants in 1999	Total emissions (kt/yr)	Global warming potential (GWP) CO <sub>2</sub> equivalents (kt/yr)	Waste incineration (fossil portion) of the total emissions (kt/yr)
Carbon dioxide (CO <sub>2</sub> )	858511	858511	8685
Nitrous oxide (N <sub>2</sub> O)	141	43710	0.81 (252)*
Methane (CH <sub>4</sub> )	3271	68691	n/a
Fluorinated hydrocarbons	3284	4290	
CF <sub>4</sub> (perfluorinated hydrocarbons)	0.186	1209	
C <sub>2</sub> F <sub>6</sub> (perfluorinated hydrocarbons)	0.046	423	
C <sub>3</sub> F <sub>8</sub> (perfluorinated hydrocarbons)	0.011	77	
SF <sub>6</sub> (sulphur hexafluoride)	0.229	5473	
<b>Total GWP</b>		<b>982384</b>	<b>(c. 9000)*</b>
<b>Indirectly effective greenhouse gases</b>			
Nitrogen oxide (NO <sub>x</sub> as NO <sub>2</sub> )	1637		15.2 (122.24)*
Carbon monoxide (CO)	4952		3.82 (11.46)*
NMVOC (non-methane volatile organic compound)	1651		0.76 (8.36)*
Ammonia (NH <sub>3</sub> )	624		0.3
<b>Aerosol formers</b>			
Sulphur dioxide SO <sub>2</sub>	831		n/a
(..)* in brackets: the converted emission value in CO <sub>2</sub> equivalents for comparison with the GWP			

**Table 3.7: Total emissions relevant to climate change in Germany in the year 1999 compared with those arising from waste incineration**  
[1, UBA, 2001]

This table indicates that in 1999 in Germany, waste incineration accounted for approximately 1 % of GHG emissions.

## 3.2 Emissions to air

### 3.2.1 Substances emitted to air

[1, UBA, 2001] [64, TWGComments, 2003].

#### Carbon monoxide

CO is an odourless toxic gas. Carbon monoxide (CO) in the flue-gas of incineration plants is the product of the incomplete combustion of carbon based compounds. CO is produced when there is insufficient oxygen locally and/or insufficiently high temperature of combustion to carry out full oxidation to carbon dioxide. In particular, this can occur if spontaneously evaporating or rapid-burning substances are present, or when combustion gas mixing with the supplied oxygen is poor. Continuous measuring of the CO level can be used to check the efficiency of the incineration process. CO is a measure of quality of combustion. If the CO emissions are very low then the gas burn out quality is very high and TOC emissions are also low (and vice versa). [74, TWGComments, 2004]

After its release to the atmosphere, CO is oxidised to CO<sub>2</sub>, after some time. Particularly high concentrations of CO (>lower explosion limit) must be avoided as they can create explosive mixtures in the flue-gas. In particular, at hazardous waste incineration plants, increased CO emissions can occur with some drummed wastes.

CO in the plants is measured continuously. Daily averages of CO emissions below 50 mg/Nm<sup>3</sup> are achieved; at some plants, the daily averages are well below this figure [64, TWGComments, 2003]

It is reported that NO<sub>x</sub> treatment with SCR may increase CO emission levels. [74, TWGComments, 2004]

### **Total organic carbon (TOC)**

This parameter includes a number of gaseous organic substances, the individual detection of which is generally complex or not possible. During the incineration of organic waste, a large number of chemical reactions take place, some of which are incomplete. This leads to an extremely complex pattern of compounds of the trace amounts. A complete account of every substance within the TOC parameter is not available, however incineration generally provides high destruction efficiencies for organic substances.

TOC can be measured continuously in the flue-gas. Low TOC levels are key indicators for the quality of combustion in an incineration process. Emissions in the range of 0.1 mg/Nm<sup>3</sup> to 10 mg/Nm<sup>3</sup> are seen. [64, TWGComments, 2003]

### **Hydrogen chloride**

Many wastes contain chlorinated organic compounds or chlorides. In municipal waste typically approximately 50 % of the chlorides come from PVC [64, TWGComments, 2003]. In the incineration process, the organic component of these compounds is destroyed and the chlorine is converted to HCl. Part of the HCl may react further to metal chlorides on inorganic compounds which are also contained in the waste.

HCl is highly soluble in water and has an impact on plant growth. It is measured continuously with emissions in the range of 0.1 - 10 mg/Nm<sup>3</sup>. [74, TWGComments, 2004]

The formation and emission of Cl<sub>2</sub> is of minor importance under normal incineration conditions. However it is essential for the fouling and corrosion. So it is worth while to control the formation so that the mentioned process takes place in the gas phase and not after deposition on boiler tubes. [74, TWGComments, 2004]

### **Hydrogen fluoride**

The formation mechanism of HF in incineration plants corresponds to that of HCl. The main sources of HF emissions in municipal waste incineration plants are probably fluorinated plastic or fluorinated textiles and, in individual cases, the decomposition of CaF<sub>2</sub> in the course of the incineration of sludge.

HCl is highly soluble in water and can have an impact on plant growth. It can be measured continuously with emissions in the range of 0.1 - 1 mg/Nm<sup>3</sup>. [74, TWGComments, 2004]

Various kinds of fluorinated waste are treated in hazardous waste incineration plants.

### **Hydrogen iodide and iodine, hydrogen bromide and bromine**

Municipal waste usually contains very small quantities of bromine or iodine compounds. Bromine or iodine emissions are, therefore, of minor importance to municipal waste incineration plants.

In hazardous waste incineration plants, organic and inorganic wastes containing bromine or iodine are sometimes treated. For example, bromine compounds can still be found in some electronic devices as flame protection agents. Iodine can be contained in medicines or may be used for the treatment of metal surfaces. On the whole, however, their quantity is small in relation to chlorinated compounds. Bromine and Iodine help to oxidise the mercury and decrease the mercury content in the clean gas by improving the retaining capacity of wet scrubbers. [74, TWGComments, 2004]

Where present, the chemical properties of elementary iodine and bromine can result in colouration of chimney plumes. Special measures can be taken for the incineration of such waste in order to prevent the formation and release of elemental bromine or iodine. These substances can also have toxic and irritant effects. [64, TWGComments, 2003]

### Sulphur oxides

If the waste contains sulphur compounds, mainly  $\text{SO}_2$  will be created during the incineration of the waste. Under appropriate reaction conditions,  $\text{SO}_3$  can also be created. For MSW, the proportion of  $\text{SO}_3$  can be around 5 % at the inlet to the FGT (note: the  $\text{SO}_3$  content is important to determine the acid dew point). Common sources of sulphur in some waste streams are: waste paper; plaster board (calcium sulphate), and sewage sludges. [64, TWGComments, 2003].

$\text{SO}_2$  gives rise to acidification and can be measured continuously with emissions in the range of 1 - 50  $\text{mg}/\text{Nm}^3$  (stp; 11 %  $\text{O}_2$ ). [74, TWGComments, 2004]

### Nitrogen oxides

Various oxides of nitrogen are emitted from incineration plants. They can have toxic, acidic and global warming effects depending on the oxide concerned. In many cases they are measured using continuous emission monitors.

The  $\text{NO}$  and  $\text{NO}_2$  emitted from waste incineration plants originates from the conversion of the nitrogen contained in the waste (so-called fuel  $\text{NO}_x$ ) and from the conversion of atmospheric nitrogen from the combustion air into nitrogen oxides (thermal  $\text{NO}_x$ ). In municipal waste incineration plants, the proportion of thermal  $\text{NO}_x$  is usually very low due to lower temperatures in the afterburner chamber. Production of thermal  $\text{NO}_x$  generally becomes more significant at temperatures above 1000 °C. In MSWI the amount of thermal  $\text{NO}_x$  can also critically depend on the quantity, and manner, of injection of secondary air into the afterburner chamber – with higher  $\text{NO}_x$  seen with higher nozzle temperatures (i.e. above 1400 °C).

The mechanisms for the formation of  $\text{NO}_x$  from the nitrogen contained in the waste are very complicated. Amongst other reasons, this is because nitrogen can be contained in the waste in many different forms, which, depending on the chemical environment, can react either to  $\text{NO}_x$  or to elementary nitrogen. A conversion rate of approx. 10 - 20 % of the fuel nitrogen is usually assumed depending on waste type. High chlorine and sulphur concentrations,  $\text{O}_2$  content and temperature may have great influence. The proportion of  $\text{NO}/\text{NO}_2$  in the total  $\text{NO}_x$  stack emissions is usually approx. 95 %  $\text{NO}$  and 5 %  $\text{NO}_2$ .

Nitrous oxide is not usually measured as a part of  $\text{NO}_x$  estimation. Nitrous oxide ( $\text{N}_2\text{O}$ ) can be emitted if insufficient temperature for the combustion process is applied (e.g. less than 850 °C) and there is an insufficient oxygen concentration. The  $\text{N}_2\text{O}$  emission from incineration processes are, therefore, often correlated with  $\text{CO}$  emissions.

Where SNCR is applied for de- $\text{NO}_x$ , formation of  $\text{N}_2\text{O}$  may increase, dependent upon reagent dose rates and temperature. Values of 20 - 60  $\text{mg}/\text{m}^3$  have been measured, but especially where low  $\text{NO}_x$  values are sought (i.e.  $\text{N}_2\text{O}$  can increase when higher SNCR dose rates are used to secure lower  $\text{NO}_x$  emission targets). This is particularly the case when urea is used (ammonia is the alternative reagent).

For municipal waste incineration,  $\text{N}_2\text{O}$  emissions of 1 - 12  $\text{mg}/\text{Nm}^3$  (for individual measurements) and averages of 1 - 2  $\text{mg}/\text{Nm}^3$  are seen. For the incineration of MSW in fluidised bed plants, the measured  $\text{N}_2\text{O}$  emission values (individual measurements) are usually higher.

Individual measurements in hazardous waste incineration plants have resulted in  $\text{N}_2\text{O}$  emission values of 30 to 32  $\text{mg}/\text{Nm}^3$  [64, TWGComments, 2003]

Normal  $\text{N}_2\text{O}$  emission levels for fluidised bed sludge incineration can be as low as 10  $\text{mg}/\text{Nm}^3$ , with some values reported up to 500  $\text{mg}/\text{Nm}^3$ .

Whilst incineration is a low (in terms of anthropogenic emissions) contributor of emissions of nitrous oxide, they add to the global warming impact of releases from incineration processes.

NO<sub>x</sub> gives rise to acidification and eutrophication and can be measured continuously. Emissions at modern plants are reported to be generally in the range between 30 and 200 mg/Nm<sup>3</sup>. (daily average, stp, 11 % O<sub>2</sub>). [74, TWGComments, 2004] Some installation may give rise to daily average NO<sub>x</sub> levels of up to 400 mg/Nm<sup>3</sup> – in general these are already in the process of closing down or upgrading to the daily average levels of 200 mg/Nm<sup>3</sup> required by Directive 2000/76/EC.

### Dust

Dust emissions from waste incineration plants mainly consist of the fine ash from the incineration process that are entrained in the gas flow. Depending on the reaction balance, other elements and compounds are concentrated in this airborne dust. The separation of dust from the flue-gas using air pollution control devices removes the majority of the dust and entrained inorganic and organic substances (e.g. metal chlorides, PCDD/F, etc).

Air pollution control equipment greatly reduces emissions of total particulate matter from waste incineration plants. In common with all combustion processes, the type of air pollution control equipment used effects the particle size distribution of the emitted dust. The filtration equipment is generally more effective on the larger particles, and therefore changes the proportion of finer particulate in the resulting emissions to air, whilst reducing the total particulate emission.

Dust is normally measured continuously with reported emissions of between <0.05 and 15 - mg/Nm<sup>3</sup> (stp, 11 % O<sub>2</sub>). [74, TWGComments, 2004]

### Mercury and mercury compounds

Mercury can currently still be found in municipal waste, notably in the form of batteries, thermometers, dental amalgam, fluorescent tubes or mercury switches. Separate collection of these can help reduce overall loads in mixed MSW but collection rates of 100 % are not achieved in practice.

Mercury is a highly toxic metal. Without adequate air pollution controls, the incineration of mercury containing wastes can give rise to significant emissions.

Emissions can be continuously measured and abated levels have been reported to be generally in the range between 0.0014 and 0.05 mg/Nm<sup>3</sup> (11 % O<sub>2</sub>). [74, TWGComments, 2004] Short-term higher emission levels are reported where inlet concentration vary greatly.

In hazardous waste incineration, there are several specific streams that may contain increased concentrations of mercury in the received waste:

- tars from coking plants
- waste from chlorine alkaline electrolysis (amalgam process)
- caustic oil sludge from refineries
- chemicals containing mercury.

The form of the mercury emissions depends strongly on the chemical environment in the flue-gas. A balance between metallic mercury (Hg<sub>0</sub>) and HgCl<sub>2</sub> normally develops. Where there is a sufficiently high concentration of HCl in the flue-gas (in relation to the reduction agent SO<sub>2</sub>) mercury will mainly be contained in the flue-gas as HgCl<sub>2</sub>. This can be separated from the flue-gas significantly more easily than metallic mercury. If, however, HCl is contained in the flue-gas at lower concentrations (e.g. in sewage sludge incineration plants) mercury exists in the flue-gas mainly in metallic form and is then more difficult to control.

The combustion temperature also influences HgCl<sub>2</sub> formation.

In wet scrubbers (only) the HgCl<sub>2</sub> removed can be reduced if SO<sub>2</sub> is also present (the separation of these substances is one reason why distinct wet scrubber stages are operated for the removal of HgCl<sub>2</sub> and SO<sub>2</sub>) The Hg<sub>2</sub>Cl<sub>2</sub> formed when this happens can itself disproportionate to HgCl<sub>2</sub> and Hg. These reactions can be prevented by adjusting the pH in wet scrubbers to low values and by withdrawing Hg from the scrubber effluent.

Metallic mercury is virtually insoluble in water (59µg/l at 25 °C). Mercuric (II) chloride is much more soluble at 73 g/l. Mercury (II) chloride can therefore be separated in wet scrubbers, whereas the separation of metallic mercury requires further flue-gas treatment stages (see Section 2.5.6 for further details).

[64, TWGComments, 2003]

### **Cadmium and thallium compounds**

Common sources of cadmium in municipal waste incineration plants are electronic devices (including accumulators), batteries, some paints and cadmium-stabilised plastic. Thallium is virtually non-existent in municipal waste.

Hazardous wastes may contain high concentrations of Cd and Tl compounds. Effluent treatment sludges and drummed wastes from metal plating and treatment may be significant sources.

Cadmium is highly toxic and can accumulate in the soil. The range of emissions have been reported to be 0.0002 to 0.2 mg/Nm<sup>3</sup>. (11 % O<sub>2</sub>). [74, TWGComments, 2004]

### **Other heavy metal compounds**

This term comprises the heavy metals antimony, arsenic, lead, chromium, cobalt, copper, manganese, nickel, vanadium, tin and their respective compounds. European and many national regulations, thus, group them together for emission measurement requirements. This group contains carcinogenic metals and metal compounds such as arsenic and chromium (VI) compounds, as well as metals with toxicity potential.

The retention of these metals depends largely on an effective separation of dust as they are bound in dust due to the vapour pressures of their compounds, as contained in the flue-gas (mainly oxides and chlorides).

### **Polychlorinated biphenyls**

Low quantities of polychlorinated biphenyls (PCBs) are found in most municipal waste streams and also in some industrial wastes. Wastes with large proportions of PCBs, however, generally only arise from specific PCB collection and destruction programmes, when concentrations of PCB in such waste can be very high.

In hazardous waste incineration plants, wastes with a PCB content as high as 60 - 100 % are combusted. The same applies to special plants for the incineration of highly chlorinated hydrocarbons. PCBs are more efficiently destroyed if higher incineration temperature are used (e.g. above 1200 °C); however, lower temperatures (e.g. 950 °C) together with appropriate conditions of turbulence and residence time have also been found to be effective for PCB incineration. [74, TWGComments, 2004] PCBs contained in the crude flue-gas of waste incineration plants can be the result of incomplete destruction.

PCB emissions are classified as potentially toxic by some international organisations (e.g. WHO). A toxicity potential (similar to that of dioxins and furans) is ascribed to some of the PCBs (coplanar PCBs).

### **Polyaromatic hydrocarbons**

Polyaromatic hydrocarbons are well known as products of incomplete combustion. They are toxic and have carcinogenic and mutagenic properties. [74, TWGComments, 2004]

### **Polychlorinated dibenzo-dioxins and furans (PCDD/F)**

Dioxins and furans (PCDD/F) are a group of compounds, some of which are of extreme toxicity, and are considered to be carcinogens. Dioxins and furans have played a main part in the debate about waste incineration for many years. Their production and release is not specific to waste incineration but occurs in all thermal processes under certain process conditions.

[64, TWGComments, 2003] Significant advances in PCDD/F emission control have been achieved in recent years in the WI sector. Improvements in the design and operation of combustion and flue-gas treatment systems have resulted in systems that can reliably achieve very low emission limit values. National [44, RVF, 2001] and regional emissions inventories confirm that, where compliance with Directive 2000/76/EC is secured, incineration represents a low contributor to overall emissions to air of dioxins and furans [45, FEAD, 2002].

[64, TWGComments, 2003] In well designed and operated incineration plants, material balances have shown that incineration effectively removes dioxins from the environment (see Section 3.1.2). This balance is made most favourable by ensuring that:

- incoming dioxins and pre-cursors are effectively destroyed using appropriate combustion conditions
- reducing the use of conditions that may give rise to PCDD/F formation and re-formation including *de-novo synthesis*.

Dioxins and furans entering the process with the waste are destroyed very efficiently if sufficiently high incineration temperatures and appropriate process conditions are used. Standards for operating conditions are stated in existing European legislation on incineration (i.e. Directive 2000/76/EC). The dioxins and the furans found in the crude flue-gas of waste incineration plants are the result of a re-combination reaction of carbon, oxygen and chlorine. Suitable precursor substances (e.g. from chlorophenols) can also react to form dioxins and furans. In the formation of the substances, certain catalysers in the form of transitional metal compounds (e.g. copper) also play an important part.

#### **Ammonia**

Ammonia has a significant impact on eutrophication and acidification of the environment. Ammonia emissions can arise from the overdosing or poor control of NO<sub>x</sub> reduction reagents that are used for NO<sub>x</sub> control. The emissions normally range from 1 to 10 mg/Nm<sup>3</sup>, with an average of 4 mg of NH<sub>3</sub>/Nm<sup>3</sup>.

[64, TWGComments, 2003]

#### **Carbon Dioxide (CO<sub>2</sub>)**

If one tonne of municipal waste is combusted, approx. 0.7 to 1.7 tonnes of CO<sub>2</sub> is generated. This CO<sub>2</sub> is released directly into the atmosphere and, as a result, the climate relevant share of CO<sub>2</sub>, (resulting from the fossil origin) contributes to the greenhouse effect. [64, TWGComments, 2003]

Because municipal waste is a heterogeneous mixture of biomass and fossil material, the portion of CO<sub>2</sub> from MSWIs of fossil origin (e.g. plastic) which is considered relevant to climate change is generally in the range 33 to 50 %.

#### **Methane CH<sub>4</sub>**

It can be assumed that, if combustion is carried out under oxidative conditions, methane levels in the flue-gas will be almost zero and consequently not emitted to air. Methane is measured with the VOC component. [64, TWGComments, 2003]

Methane can also be created in the waste bunker if there are low oxygen levels and subsequent anaerobic processes in the waste bunker. This is only the case where wastes are stored for long periods and not well agitated. Where the storage area gases are fed to the incineration chamber air supply they will be incinerated and emissions will be reduced to insignificant levels.

### 3.2.2 Municipal waste incineration plants

#### 3.2.2.1 Summary data for emissions to air from MSWI

Table 3.8 gives the range of values for emissions to air from some European MSWI plants. Thirty minute, daily and annual averages are shown. It is important to note that data that are the result of non-continuous (or spot) measurements are also included in the Table. They are indicated (N) in the *type of measurement* column. Furthermore, where non-continuous measurements appear in an *averaging* column, the values presented for non-continuous measurements are not collected over the stated averaging period for that column, and should only be interpreted as non-continuous measurements:

Parameter	Type of Measurement	Daily averages (where continuous measurement used) in mg/m <sup>3</sup>		Half hour averages (where continuous measurement used) in mg/m <sup>3</sup>		Annual averages mg/m <sup>3</sup>
		Limits in 2000/76/EC	Range of values	Limits in 2000/76/EC	Range of values	Range of values
Dust	C	10	0.1 – 10	20	<0.05 – 15	0.1 – 4
HCl	C	10	0.1 – 10	60	<0.1 – 80	0.1 – 6
HF	C/N	1	0.1 – 1	4	<0.02 – 1	0.01 – 0.1
SO <sub>2</sub>	C	50	0.5 – 50	200	0.1 – 250	0.2 – 20
NO <sub>x</sub>	C	200	30 – 200	400	20 – 450	20 – 180
NH <sub>3</sub>	C	n/a	<0.1 - 3		0.55 – 3.55	
N <sub>2</sub> O		n/a				
VOC (as TOC)	C	10	0.1 – 10	20	0.1 – 25	0.1 – 5
CO	C	50	1 – 100	100	1 – 150	2 – 45
Hg	C/N	0.05	0.0005 – 0.05	n/a	0.0014 – 0.036	0.0002 – 0.05
Cd	N	n/a	0.0003 – 0.003	n/a		
As	N	n/a	<0.0001 – 0.001	n/a		
Pb	N	n/a	<0.002 – 0.044	n/a		
Cr	N	n/a	0.0004 – 0.002	n/a		
Co	N	n/a	<0.002	n/a		
Ni	N	n/a	0.0003 – 0.002	n/a		
Cd and Tl	N	0.05		n/a		0.0002 – 0.03
Σ other metals 1	N	0.5		n/a		0.0002 – 0.05
Σ other metals 2	N	n/a	0.01 – 0.1	n/a		
Benz(a)pyrene	N	n/a		n/a		<0.001
Σ PCB	N	n/a		n/a		<0.005
Σ PAH	N	n/a		n/a		<0.01
PCDD/F (ng TEQ/m <sup>3</sup> )	N	0.1 (ng TEQ/m <sup>3</sup> )		n/a		0.0002 – 0.08 (ng TEQ/m <sup>3</sup> )

<sup>1</sup> In some cases there are no emission limit values in force for NO<sub>x</sub>. For such installations a typical range of values is

250 - 550 mg/Nm<sup>3</sup> (discontinuous measurement).

2. Other metals 1 = Sb, As, Pb, Cr, Co, Cu, Mn, Ni, V

3. Other metals 2 = Sb, Pb, Cr, Cu, Mn, V, Co, Ni, Se and Te

4. Where non-continuous measurements are indicated (N) the averaging period does not apply. Sampling periods are generally in the order of 4 – 8 hours for such measurements.

5. Data is standardised at 11 % Oxygen, dry gas, 273K and 101.3kPa.

**Table 3.8: Range of clean gas operation emissions levels reported from some European MSWI plants.**

[1, UBA, 2001], [2, infomil, 2002], [3, Austria, 2002], [64, TWGComments, 2003]



Table 3.9 below gives emissions to air for various substances per tonne of MSW incinerated. The data given is average data for 12 MSWI in the Flanders Region of Belgium in 1999 and average data for three MSWI plants in Austria [3, Austria, 2002]:

Parameter	Average Value (g/tonne incinerated)	
	12 Belgian plants	3 Austrian plants
Dust	165	7
HCl	70	4
HF	2.2	0.36
SO <sub>2</sub>	129	24.8
NO <sub>x</sub>	2141	189
CO	126	101
TOC	19	-
Hg	0.048	0.1
Cd + Tl	0.095	-
Sb, As, Pb, Cr, Co, Cu, Mn, Ni, V, Sn	1.737	-
PCDD/F	250 ng TEQ/tonne incinerated	44.4 ng TEQ/tonne incinerated

**Table 3.9: Operational emission levels to air from MSWI expressed per tonne of MSW incinerated** [64, TWGComments, 2003] [3, Austria, 2002] [74, TWGComments, 2004]

### 3.2.2.2 European air emissions survey data for MSWI

The data presented here are based on the results of a survey of 142 European non-hazardous waste incineration plants submitted to the TWG [45, FEAD, 2002], with additional information from comments made by the TWG [64, TWGComments, 2003]

The information relates to process lines rather than individual plants. The size of the data set may therefore, in some cases, exceed the number of plants surveyed. The data set is not a complete survey of European MSWIs - most of the plants that were complying only with the earlier 1999 Waste Incineration Directives, were excluded from this survey.

#### Hydrogen chloride and hydrogen fluoride

Different national emission limit values apply.

Most of the data presented are based on continuous measurements.

Level of annual averages	Number of plants/lines
>50 mg/Nm <sup>3</sup>	0
>30 <50 mg/Nm <sup>3</sup>	10
>10 <30 mg/Nm <sup>3</sup>	24
>5 <10 mg/Nm <sup>3</sup>	35
<5 mg/Nm <sup>3</sup>	73
Note: For German plants only some representative examples have been taken into account. All the other incinerators (about 50 plants) not mentioned here also operate below 10 mg/Nm <sup>3</sup> .	

**Table 3.10: HCl emissions survey of European MSWIs**  
Source [45, FEAD, 2002]

Basically three types of flue-gas cleaning systems are in use:

1. wet systems using different types of scrubbers in which the HCl is taken out by water, working normally at a pH <1
2. semi-wet systems, which use lime in water
3. dry systems, which use lime or sodium bicarbonate (usually with activated carbon) often combined with a bag house filter.

[74, TWGComments, 2004]

The emissions will depend, among other factors, on the amount of additives used and the operational/design set point of the plant.

The data on hydrogen fluoride (HF) are mainly based on discontinuous measurement. HF is reduced by the same tools as HCl, meaning that an effective flue-gas cleaning system for HCl will also deal with HF. The chemical behaviour of HF is not exactly the same as of HCl, so the efficiency of HF removal will differ slightly from system to system.

Level of annual averages	Number of plants/lines
>5 <10 mg/Nm <sup>3</sup>	0
>2 <5 mg/Nm <sup>3</sup>	1
>1 <2 mg/Nm <sup>3</sup>	1
<1 mg/Nm <sup>3</sup>	53

**Table 3.11: HF emissions survey of European MSWIs**  
[45, FEAD, 2002]

### Sulphur-dioxide

Different national emission limit values are applied.

Most of the data are from continuous measurement.

Level of annual averages	Number of plants/lines
>200 mg/Nm <sup>3</sup>	3
>100 <200 mg/Nm <sup>3</sup>	5
>50 <100 mg/Nm <sup>3</sup>	16
>25 <50 mg/Nm <sup>3</sup>	25
<25 mg/Nm <sup>3</sup>	123

**Table 3.12: Sulphur dioxide emissions survey of European MSWIs**  
[45, FEAD, 2002]

The types of flue-gas cleaning in use are the same as those mentioned for HCl, with the main difference being that, for wet scrubbers, they are operated at a slightly basic pH (usually 7 - 8).

### Dust

Most of the data are from continuous measurement. They show the values of total dust.

For dust, mainly three types of flue-gas cleaning are in use:

1. dry electrostatic precipitator (dry ESP)
2. wet electrostatic precipitator (wet ESP) (note: the wet ESP is not often used in MSWI)
3. bag house filter (BF).

In several cases (mainly in NL and D), two of these tools have been combined with each other, for example a dry electrostatic precipitator directly after the boiler with a bag house filter directly before the stack.

Recent new plants have been built with a bag house filter only.

Wet scrubbers can also significantly contribute to dust removal. Typically about 50 % efficiency is observed for dust (with additional selected heavy metal) removal.

An important point to note is that, all tools are connected and generally have an influence on each other. In the case of dry and semi-wet processes, bag filters also act as a reactor for acid removal. In addition they can remove PCDD/F and metals (including mercury and cadmium) if a suitable reagent is used e.g. activated carbon.

Level of annual averages	Number of plants/lines
>50 mg/Nm <sup>3</sup>	3
>30 <50 mg/Nm <sup>3</sup>	1
>10 <30 mg/Nm <sup>3</sup>	8
>5 <10 mg/Nm <sup>3</sup>	29
<5 mg/Nm <sup>3</sup>	103

**Table 3.13: Dust emissions survey of European MSWIs**  
[45, FEAD, 2002]

### Nitrogen oxides

Most of the data presented are from continuous measurements. In some countries there are currently no limit values for NO<sub>x</sub> from municipal waste incinerators.

Many plants already achieve results below 200 mg/Nm<sup>3</sup>. In some cases emissions of less than 70 mg/Nm<sup>3</sup> are achieved.

A variety of combustion control techniques are used to reduce NO<sub>x</sub> formation. SCR or SNCR are the main techniques in use for the further abatement of NO<sub>x</sub> emissions in MSWIs. Emission values below 100 mg/Nm<sup>3</sup> normally require the use of SCR. The use of SNCR can also lead to emissions below 150 mg/Nm<sup>3</sup> and exceptionally below 100 mg/Nm<sup>3</sup> (e.g. when primary NO<sub>x</sub> reduction measures are also implemented) [74, TWGComments, 2004]

Level of annual averages	Number of plants/lines
>400 mg/Nm <sup>3</sup>	9
>300 <400 mg/Nm <sup>3</sup>	35
>200 <300 mg/Nm <sup>3</sup>	22
>100 <200 mg/Nm <sup>3</sup>	48
<100 mg/Nm <sup>3</sup>	11
Note: the 11 plants (not lines) below 100 mg/Nm <sup>3</sup> are in NL – all comply with applied ELVs of 70 mg/Nm <sup>3</sup> . Other plants operating below 100 but not included here are found in Europe (commonly in D, A, B)	

**Table 3.14 Nitrogen oxides emissions survey of European MSWIs**  
Source [45, FEAD, 2002], [64, TWGComments, 2003]

### TOC (Total organic carbon)

TOC is an important measure of the efficiency of combustion. The achieved levels of the TOC-emissions are mainly a result of the design of the firing system and the after-burning chamber, as the possibilities to decrease those emissions by flue-gas cleaning are limited. The same equipment used for dust will reduce solid organic particles. Some of the organic compounds will be reduced by the use of activated carbon.

Level of annual averages	Number of plants/lines
>10 mg/Nm <sup>3</sup>	4
>5 <10 mg/Nm <sup>3</sup>	7
<5 mg/Nm <sup>3</sup>	79

**Table 3.15: Total organic carbon emissions survey of European MSWIs**  
[45, FEAD, 2002]

## PCDD/PCDF

The data on PCDD/PCDF emissions from MSWI do not represent the whole range of plants currently operating. Data from Denmark and Italy were not available. Data from France are also not included, although the data for these showed emission above 0.1ng/m<sup>3</sup> in many cases.

PCDD/PCDF emissions reported here are all based on discontinuous measurements, mainly twice a year. There is experience on continuous collection of dioxin measurements especially for MSWI in Flanders (B) and in Austria.

For reaching low levels of PCDD/PCDF emissions, primary as well as secondary measures are important. In the firing system, effective mixing of the gases (high turbulence) improves the destruction of PCDD/PCDF and similar compounds already present in the waste. Avoiding the temperature window for the recombination of PCDD/PCDF and similar compounds in the boiler and flue-gas treatment system avoids the breeding of new PCDD/Fs.

For further reduction, mainly three types of flue-gas cleaning are in use:

1. static activated carbon filter
2. bag house filter with injection of activated carbon (usually mixed with other reagents)
3. catalyst destruction for gaseous PCDD/F

Both the activated carbon systems above have the advantage of also reducing Mercury emissions. The catalyst systems are used to reduce NO<sub>x</sub> and PCDD/F.

Level of annual averages	Number of plants/lines
>2 ng/Nm <sup>3</sup>	3
>1 <2 ng/Nm <sup>3</sup>	11
>0.5 <1 ng/Nm <sup>3</sup>	4
>0.1 <0.5 ng/Nm <sup>3</sup>	7
>0.05 <0.1 ng/Nm <sup>3</sup>	22
<0.05 ng/Nm <sup>3</sup>	72

**Table 3.16: PCDD/F (TEQ) emissions survey of European MSWIs**  
[45, FEAD, 2002], [64, TWGComments, 2003]

## Mercury

The data include results from continuous measurement (used in Germany for over two years and Austria for over one year) and from discontinuous measurements (minimum twice a year). Therefore, comparability of data between these two types of measurement may be not very high. Continuous measurements will also include events with elevated emissions due to higher loads in the waste feed, which have been reported by some plants.

Level of annual averages	Number of plants/lines
>200 µg/Nm <sup>3</sup>	0
>100 <200 µg/Nm <sup>3</sup>	1
>50 <100 µg/Nm <sup>3</sup>	3
>30 <50 µg/Nm <sup>3</sup>	7
<30 µg/Nm <sup>3</sup>	83

**Table 3.17: Mercury emissions survey of European MSWIs**  
[45, FEAD, 2002]

For several plants in France, mercury measurements are not given alone but in combination with Cd (the ELV being given as a sum of the two). As the distribution of the two is not necessarily predictable, these results are presented in the following additional table:

Level of annual averages	Number of plants/lines
>200 $\mu\text{g}/\text{Nm}^3$	0
>100 <200 $\mu\text{g}/\text{Nm}^3$	1
>50 <100 $\mu\text{g}/\text{Nm}^3$	5
>30 <50 $\mu\text{g}/\text{Nm}^3$	8
<30 $\mu\text{g}/\text{Nm}^3$	18

**Table 3.18: Combined Cd and Hg emissions of selected MSWIs in France**  
[45, FEAD, 2002]

The plants from which data are included in this report are equipped with, amongst others, the following types of flue-gas cleaning systems. The Hg emission levels reported are also shown:

System identifier	Dry ESP	Wet acid scrubber	Wet ESP	Bag house filter	Activated carbon injection	Activated carbon filter	Emission of Hg ( $\mu\text{g}/\text{Nm}^3$ )
1	✓	✓	✓	✓	✓		0.1
2		✓		✓		✓	0.1
3				✓	✓		1.77 and 1.93 and 3.16
4	✓	✓				✓	3
5		✓		✓	✓		3 and 6
6		✓		✓			2 and 7.3 and 10
7				✓			22 and 50

**Table 3.19: Emission results and techniques applied for Hg control at European MSWIs**  
[45, FEAD, 2002]

The lowest results are seen where activated carbon is used, either as a static bed system, or in an entrained flow activated carbon injection system with a bag filter. The consumption rate as well as the quality of activated carbon (e.g. sulphur impregnation) directly affects the emission levels. The techniques in Table 3.19 correspond to different ELVs requirements and to different costs.

Under certain conditions (e.g. high input rate of mercury) the removal capacity limits of a FGT systems may be exceeded, leading to temporarily elevated Hg emissions. MSW usually contains low quantities of Hg. However, some short-term high loads have been noted. These are generally associated with the inclusion in the MSW of batteries, electrical switches, thermometers, laboratory wastes, etc.

The wet acidic scrubber can serve as a sink for mercury if the mercury is present as the Hg(II), chloride form. The mercury that has been transferred from the gas stream to the scrubber liquors can then be removed by a waste water treatment plant or captured by spray drying of the waste water in the flue-gas. In the second case mercury recycles can occur unless there is an adequate rate Hg removal step.

Additional treatment may be required if mercury is present as metallic form (see Hg removal techniques).

[74, TWGComments, 2004]

### 3.2.2.3 Emissions to air from fluidised bed incinerators

Efficient heat and mass transfer allows operation at lower temperatures than other combustor designs, but there is still a lower limit. The lower temperatures often used together with the more uniform distribution of temperatures, which eliminates hot spots and high oxygen zones, thermal NO<sub>x</sub> production may then be reduced and the conversion of fuel nitrogen into NO<sub>x</sub> can also be very low. The lower combustion temperatures together with the lack of air can sometimes lead to the formation of nitrous oxide (N<sub>2</sub>O). Normal N<sub>2</sub>O emission levels for fluidised bed sludge incineration are approx 10 mg/Nm<sup>3</sup>, with some values reported up to 100 mg/Nm<sup>3</sup> and above. These values are higher than with other combustion systems.

The generally lower NO<sub>x</sub> production that results from combining prepared or selected wastes with fluidised bed combustion can lead to similar or lower emission levels using simpler FGT than inherently high NO<sub>x</sub> combustion systems.

Due to relatively lower temperature of the fluidised bed combustion, the contents of heavy metals in the raw flue-gas (and hence FGT residues) may be lower than from mixed waste grate combustion. The actual emissions to air depend on the waste, and on the chosen flue-gas cleaning system.

A combination of fluidised bed incineration at 850 - 950 °C and SNCR (ammonia) is reported to reduce NO<sub>x</sub> emissions at Dutch sewage sludge incinerators to less than 70 mg/Nm<sup>3</sup>. [2, infomil, 2002]

### 3.2.3 Hazardous waste incineration plants

#### 3.2.3.1 Summary data of the emissions to air from HWI

Table 3.20 represents the results of a survey of European (mainly German and Dutch) operators of plants with regard to typical emissions from plants. Thirty minute, daily and annual averages are shown. It is important to note that data that are the result of non-continuous measurements are also included in the table, and is indicated (N) in the type of measurement column. Furthermore, where non-continuous measurements appear in an averaging column, the values presented for non-continuous measurements are not collected over the stated averaging period for that column, and should only be interpreted as non-continuous measurements:

Parameter	Type of measurement C: cont. N: non-cont.	Daily averages (mg/Nm <sup>3</sup> )		Thirty-minute Averages (mg/Nm <sup>3</sup> )		Annual averages (mg/Nm <sup>3</sup> )
		Limits in 2000/76/EU	Typical range of values	Limits in 2000/76/EU	Typical range of values	Typical range of values
Dust	C	10	0.1 – 10	20	0.1 – 15	0.1 – 2
HCl	C	10	0.1 – 10	60	0.1 – 60	0.3 – 5
HF	C/N	1	0.04 – 1	4	0.1 – 2	0.05 – 1
SO <sub>2</sub>	C	50	0.1 – 50	200	0.1 – 150	0.1 – 30
NO <sub>x</sub>	C	200	40 – 200	400	50 – 400	70 – 180
TOC	C	10	0.1 – 10	20	0.1 – 20	0.01 – 5
CO	C	50	5 - 50	100	5 – 100	5 – 50
Hg	C/N	0.05	0.0003 – 0.03	n/a	0.0003- 1	0.0004 – 0.05
Cd +Tl	N	0.05	0.0005 – 0.05	n/a		0.0005 – 0.05
Σ other heavy metals	N	0.5	0.0013 – 0.5	n/a		0.004 – 0.4
PCDD/PCDF (ng TEQ/m <sup>3</sup> )	N	0.1	0.002 – 0.1	n/a		0.0003 – 0.08

1. Data is standardised at 11 % Oxygen, dry gas, 273K and 101.3kPa.  
2. Other metals = Sb, As, Pb, Cr, Co, Cu, Mn, Ni, V

**Table 3.20: Typical range of clean gas emissions to air from hazardous waste incineration plants [1, UBA, 2001], [2, infomil, 2002], [64, TWGComments, 2003], [74, TWGComments, 2004]**

### 3.2.3.2 European air emissions survey data for HWI

[41, EURITS, 2002]

This section gives an overview of the merchant hazardous waste incineration sector in the EU. Information is given for 24 European merchant rotary kiln installations which collectively have a total annual capacity of 1500000 tonnes of waste (70 % of the total capacity of specialised waste incinerators in the EU that is commercially available to third parties). On-site installations, such as those in the chemical industry, are not considered in this overview. The reference year for data collection is 1999 - 2000. Some specific data are more recent and refer to the year 2001 - 2002.

There is a very high diversity of waste streams treated in these installations. Composition and physical constitution can vary a lot from kiln to kiln and for each kiln over a period of time. For this reason the kilns are equipped with sophisticated flue-gas cleaning systems.

#### General overview

Due to efficient flue-gas cleaning, the air emissions of the different installations covered in this survey already meet the emission standards of Directive 2000/76/EC on incineration of waste.

In Table 3.21 below, an overview is given of the emissions of the waste incinerators as average yearly concentrations. The minimum and maximum values of the individual installations, and the average of all installations, are also given.

Parameter mg/Nm <sup>3</sup> unless stated	Yearly average		
	Minimum	Maximum	Average
HF	0.01	<1	0.3
TOC	0.01	6	1.5
O <sub>2</sub> (%)	8	13.66	11.0
NO <sub>x</sub>	44.4	<300	139
Dust	0.075	9.7	1.69
HCl	0.25	8.07	1.56
SO <sub>2</sub>	0.1	22.7	7.8
Hg	0.0004	0.06	0.01
Cd +Tl	0.00014	0.046	0.01
Sum metals	<0.004	0.84	0.2
PCDD/PCDF (ngTEQ/Nm <sup>3</sup> )	0.0003	<0.1	0.038
CO	3	26	12.9

**Table 3.21: Survey data of the annual average emissions to air from hazardous waste incinerators in Europe**

[41, EURITS, 2002]

In Table 3.22 below, the average of the mass flows (in kg/t of incinerated waste) for some substances, together with the total amount of all the installations (if recorded) are given. The latter demonstrates the outputs of the sector as a result of the treatment of about 1.3 to 1.5 million tonnes of waste per year.

Parameter	Average mass flow (kg/t of waste incinerated)	Total amount recorded (t/yr)
Dust	0.0098	16.2
SO <sub>2</sub>	0.047	60.6
NO <sub>x</sub>	0.87	1191
Hg	0.000056	0.083
Sum of metals	0.0013	1.3
CO	0.07	76.2
HCl	0.0097	16.8

**Table 3.22: Survey data of mass flow and annual sector emissions to air from merchant hazardous waste incinerators in Europe**  
[41, EURITS, 2002]

### Overview by each parameter

In the following paragraphs, the emissions for each parameter are discussed in more detail. Where possible, the relationship between these emissions and the installed technology is described.

The numbering given in the X-axes of the graphs below is not related to the specific installations. Also, concentrations (bars, relating to the left Y-axis) and mass flows (diamonds, relating to the right Y-axis) are given in the graphs. Mass flows based on non-absolute values (e.g. values smaller than the determination level) are expressed as hollow diamonds.

**HF** is not described in detail because all the data collected for the 24 installations, which is mostly obtained as a result of continuous monitoring, are below 1 mg/Nm<sup>3</sup>, which is the analytical lower determination level (LDL) of this monitoring technique. Additional data obtained by discontinuous measurements, a technique with a lower detection limit, confirm this conclusion.

**TOC** is not described in detail because 95 % of the data collected, which again is mostly obtained as a result of continuous monitoring, are below 1 - 2 mg/Nm<sup>3</sup>. Two installations have higher yearly average emission of 4 and 6 mg/Nm<sup>3</sup>.

**O<sub>2</sub>** data are given to indicate that the average concentration level is close to the standard reference value of 11 %, to which all raw data have to be calculated.

### Oxides of nitrogen

In the graph below the yearly average NO<sub>x</sub> values for all installations are given and given as:

- average concentration of NO<sub>x</sub> expressed as NO<sub>2</sub>, in mg/Nm<sup>3</sup>, 11 % O<sub>2</sub>, dry and standard conditions
- average mass flow of NO<sub>x</sub> expressed as NO<sub>2</sub> in g/t of incinerated waste.

The data are the result of continuous measurements of this parameter in the flue-gas. The individual measurement points are in general integrated over half an hour, and then respectively the daily, monthly and yearly averages are calculated. The analytical lower determination level for continuous monitoring of this parameter is usually 5 - 10 mg/Nm<sup>3</sup>.

For each installation the installed NO<sub>x</sub> abatement technique is shown, which may be:

- the use of selective non catalytic reduction (indicated as SNCR)
- the use of selective catalytic reduction (indicated as SCR)
- no specific abatement technique.



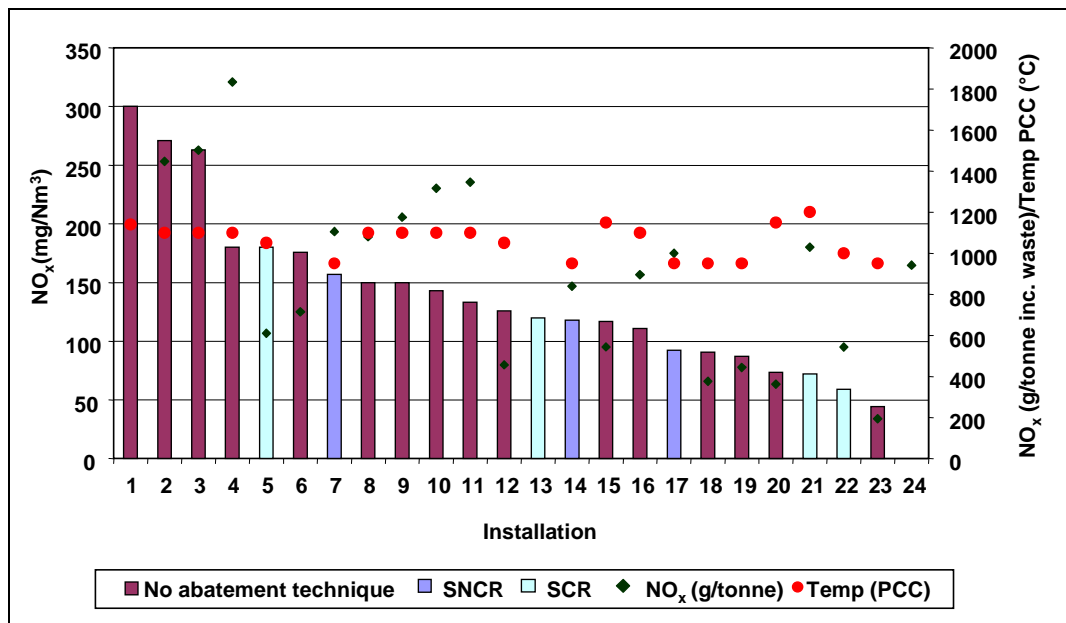

**Figure 3.1: Graph of NO<sub>x</sub> annual average emissions to air and applied abatement technique at European HWIs [41, EURITS, 2002]**

General conclusions from the graph:

- 90 % of the installations perform below 200 mg/Nm<sup>3</sup>
- 50 % of the installations perform between 50 - 150 mg/Nm<sup>3</sup>. For these there is no clear direct relationship with the abatement technique which is installed (note: some installations operate at a set point which is not the lowest level that is technically achievable, e.g. No. 5 an SCR operating at 180 mg/Nm<sup>3</sup>)
- for the four installations equipped with an SCR, the emissions are 180, 120, 72 and 59 mg/Nm<sup>3</sup>, respectively. The set point for the operation of each of these installations is different and does not necessarily reflect the lowest level that is technically achievable. In addition, the influence of conditions which determine the formation of NO<sub>x</sub> during incineration cannot be deduced from the available data
- for the three installations equipped with an SNCR, the emissions are 157, 118 and 93 mg/Nm<sup>3</sup> respectively; for these results the same remark applies as that given in previous bullet points
- for the other installations not equipped with an SCR/SNCR there is a wide variation in the emissions, mainly as a result of the different conditions for NO<sub>x</sub> formation in the individual installations
- several of the installations without SCR or SNCR but with low NO<sub>x</sub> emissions (<120 mg/Nm<sup>3</sup>) operate at lower temperatures in the post combustion chamber (PCC): 950 - 1000 °C, in comparison with other installations operating at 1100 - 1200 °C in the PCC.

## Dust

In the graph below, the yearly average dust values for all installations are given and given as:

- the average concentration of dust in mg/Nm<sup>3</sup>, 11 % O<sub>2</sub>, dry and standard conditions
- the average mass flow of dust in g/tonne incinerated waste.

The data are the result of continuous measurements of this parameter in the flue-gas. The individual measurement points are, in general, integrated over half an hour, and then respectively the daily, monthly and yearly average is calculated. The analytical lower determination level for continuous monitoring of this parameter is around 1 - 2 mg/Nm<sup>3</sup>.

For each installation the dust emission technique is indicated. In this case, there is:

- the use of electrostatic precipitators (ESPs), a dry ESP or a wet ESP
- the use of a bag house filter
- the use of a combination of these two techniques.

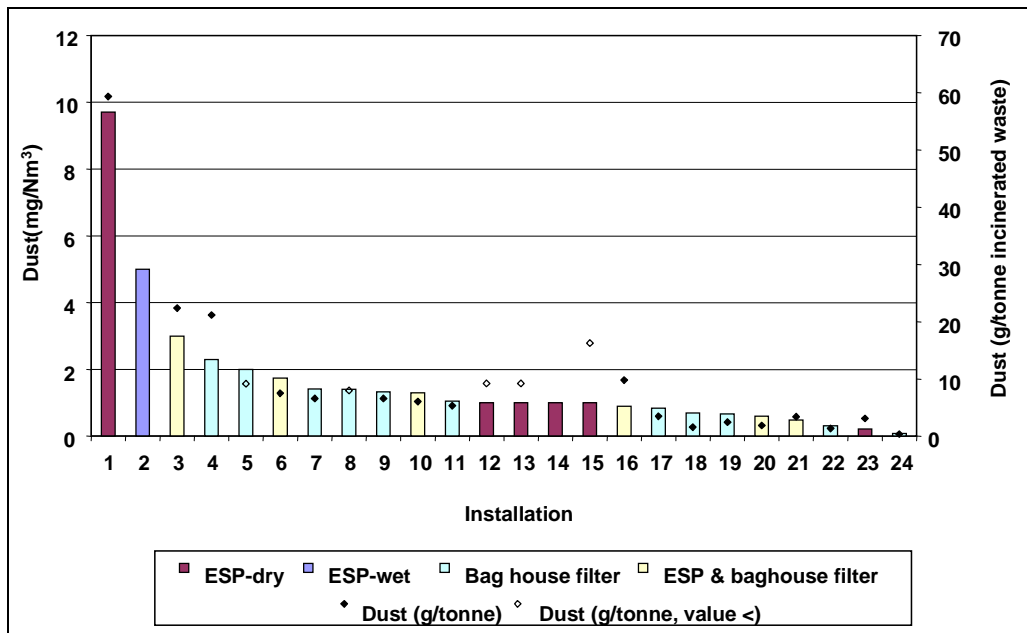

Figure 3.2: Graph of annual average dust emissions to air and applied abatement technique at European HWIs [41, EURITS, 2002]

General conclusions from the graph:

- 96 % of the installations perform below 5 mg/Nm<sup>3</sup>
- one installation has a dust emission between 5 - 10 mg/Nm<sup>3</sup>.

### HCl

In the graph below, the yearly average HCl values for all installations are given and given as:

- the average concentration of HCl and volatile chloride compounds in mg/Nm<sup>3</sup>, 11 % O<sub>2</sub>, dry and standard conditions
- the average mass flow of HCl in g/t incinerated waste.

The data are the result of continuous measurement of this parameter in the flue-gas. The individual measurement points are, in general, integrated over half an hour, and then respectively the daily, monthly and yearly average is calculated. The analytical lower determination level for continuous monitoring of this parameter is about 1 - 2 mg/Nm<sup>3</sup>.

For each installation the installed HCl abatement technique is shown. The techniques used are:

- initial quenching of the flue-gases
- the use of a wet scrubber (injection of lime-based compounds in water) with subsequent evaporation of scrubbing water
- the use of a wet scrubber with subsequent discharge of the treated scrubbing water
- the use of a dry or semi-wet scrubber with the injection of lime based compounds in water
- the injection of NaHCO<sub>3</sub>.

Most of the HCl in raw flue-gases from hazardous waste incineration originates from organics containing chlorine but some of it also comes from inorganic salts such as NaCl.

At the temperatures achieved during incineration the Deacon equilibrium is important to consider:



During the combustion of hydrocarbon-containing waste the equilibrium is shifted to the left side of the equation, due to the fact that during combustion an excess of H<sub>2</sub>O is formed, and as a result, chlorine is present in the HCl form in the combustion gas. When, for example, low hydrogen-containing waste, e.g. PCB, is incinerated this is not the case and the equilibrium is shifted to the right side of the equation, meaning that a mixture of HCl and Cl<sub>2</sub> will be formed. In this case, the flue-gas cleaning has to be adapted for the de-chlorination of the combustion gases.

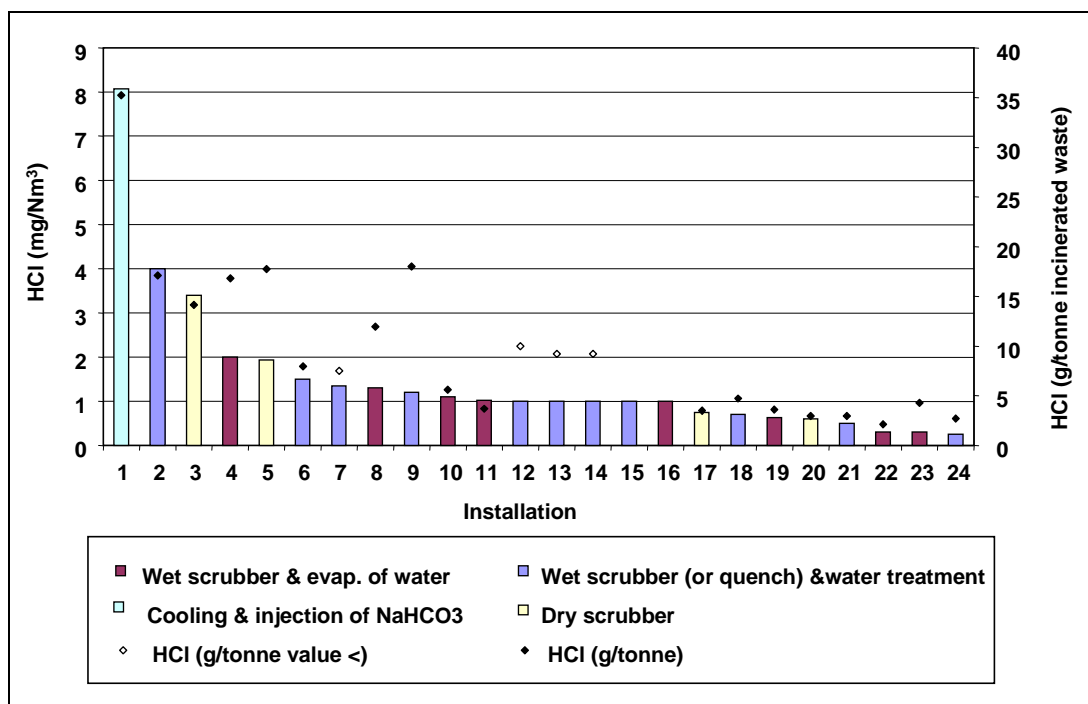

Figure 3.3: Graph of HCl annual average emissions to air and applied abatement technique at European HWIs [41, EURITS, 2002]

General conclusions from the graph:

- 90 % of the installations perform below 2 mg/Nm<sup>3</sup>
- this data does not reveal any clear relationship between technique and annual average emission levels
- for the three other installations the emissions are 8, 4 and 3 mg/Nm<sup>3</sup> respectively.

## SO<sub>2</sub>

In the graph below, the yearly average SO<sub>2</sub> values for all installations are given. These are given as:

- average concentrations of SO<sub>2</sub> in mg/Nm<sup>3</sup>, 11 % O<sub>2</sub>, dry and standard conditions
- average mass flow of SO<sub>2</sub> in g/t incinerated waste.

The data are the result of continuous measurements of this parameter in the flue-gas. The individual measurement points are in general integrated over half an hour, and then the daily, monthly and yearly average respectively is calculated. The analytical lower determination level for continuous monitoring of this parameter is around 1 - 5 mg/Nm<sup>3</sup>.

For each installation the installed SO<sub>2</sub> emission abatement technique is shown. In this case there is:

- initial quenching of the flue-gases
- the use of a wet scrubber (injection of lime-based compounds in water) and subsequently the evaporation of the scrubbing water
- the use of a wet scrubber and subsequently the discharge of the treated scrubbing water
- the use of a dry or semi-wet scrubber (injection of lime-based compounds in water)
- the injection of NaHCO<sub>3</sub> in the flue-gas transport channel.

The formation of SO<sub>2</sub> in incineration processes originates from S-compounds in the waste e.g.

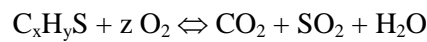

There is a direct linear relationship between the amount of SO<sub>2</sub> in the raw flue-gases and the amount of sulphur in the waste. Most sulphur containing compounds, also inorganic, degrade during combustion and end up in the raw gas as SO<sub>2</sub>.

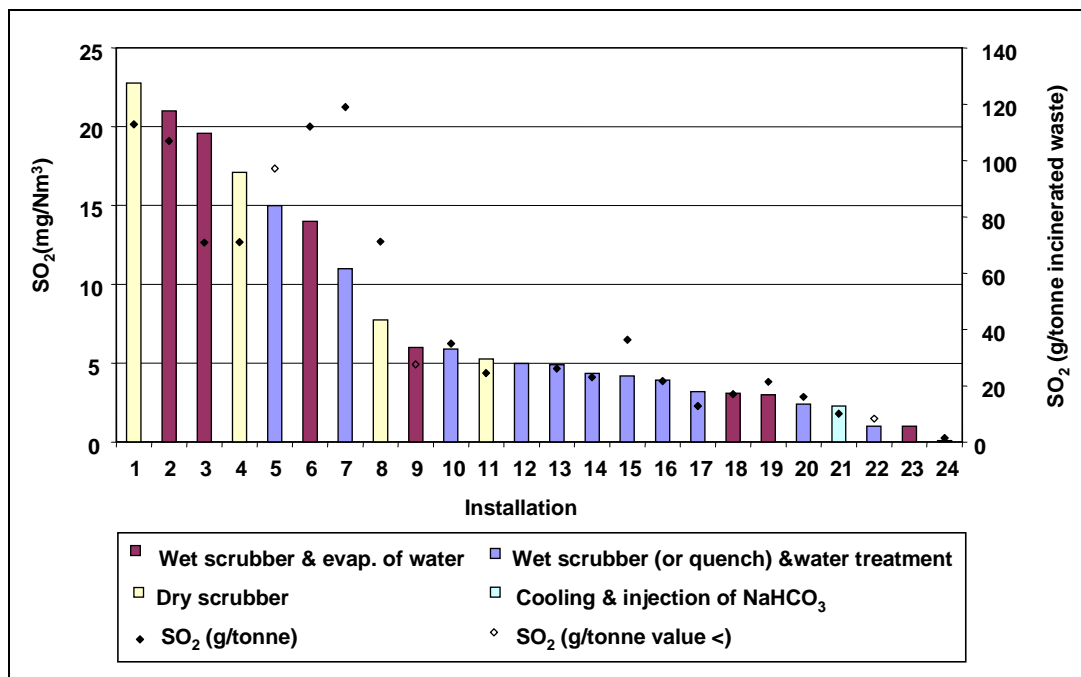

Figure 3.4: Graph of annual average sulphur dioxide emissions to air and applied abatement technique at European HWIs [41, EURITS, 2002]

General conclusions from the graph:

- 90 % of the installations perform below 20 mg/Nm<sup>3</sup>
- dry systems give results in the range of 5 – 23 mg/Nm<sup>3</sup>, with a median value of approx. 12 mg/Nm<sup>3</sup>. SO<sub>x</sub> abatement is reported to be improved with dry sodium bicarbonate than dry lime systems [74, TWGComments, 2004]
- wet systems give results in the range of 2 – 22 mg/Nm<sup>3</sup>, with a median value of approx 4 mg/Nm<sup>3</sup>
- about 50 % of the installations perform below 5 mg/Nm<sup>3</sup> which is near the analytical lower determination level for continuous monitoring of this parameter
- for the two other installations the emissions are respectively 23 and 21 mg/Nm<sup>3</sup>.

## Mercury

In the graph below, the yearly average mercury values for all installations are given. These are given as:

- the average concentration of mercury in mg/Nm<sup>3</sup>, 11 % O<sub>2</sub>, dry and standard conditions
- the average mass flow of mercury in g/t incinerated waste.

The data of eight installations are the result of continuous measurements of this parameter in the flue-gas. The individual measurement points are in general integrated over half an hour, and then the daily, monthly and yearly average respectively is calculated. The analytical lower determination level for continuous monitoring of this parameter is 1 - 2 µg/Nm<sup>3</sup>.

All of these continuously monitored installations have yearly average emission levels below 5µg/Nm<sup>3</sup>.

The data of the other installations are obtained by periodic discontinuous Hg measurements, ranging from twice a month to twice a year. The analytical lower determination level for this method is 1 µg/Nm<sup>3</sup>.

For each installation the installed mercury abatement technique is shown. In this case, there is:

- the use of a wet scrubber system (the lower the pH of the scrubbing water, the higher the removal efficiency of Hg)
- the injection of activated carbon (or an alternative reagent, e.g. brown-coal cokes)
- the use of a static activated carbon filter (or an alternative reagent, e.g. brown-coal cokes).

In the graph, the availability of activated carbon injection or the presence of an activated carbon filter is not mentioned because all the installations are equipped with it, except installations numbered 5, 6 and 11.

The mercury in the flue-gases originates from mercury-containing waste. There is a direct linear relationship between the amount of mercury in the raw flue-gases and the amount of mercury in the waste. For one installation equipped with wet gas scrubbing and an activated carbon filter, it is calculated that the total mercury input via the waste amounts to 1000 kg/yr for an installation with an incineration capacity of 50000 t/yr. Taking into account a maximum yearly-emitted Hg flow via the flue-gases of less than 1.25 kg/yr, this means a total removal efficiency of 99.99 %.

Installations with a continuously or temporarily high Hg input are able to add sulphur-containing reagents in the wet scrubber system to increase the removal efficiency of Hg. The screening of the waste inputs for Hg is, therefore, important.

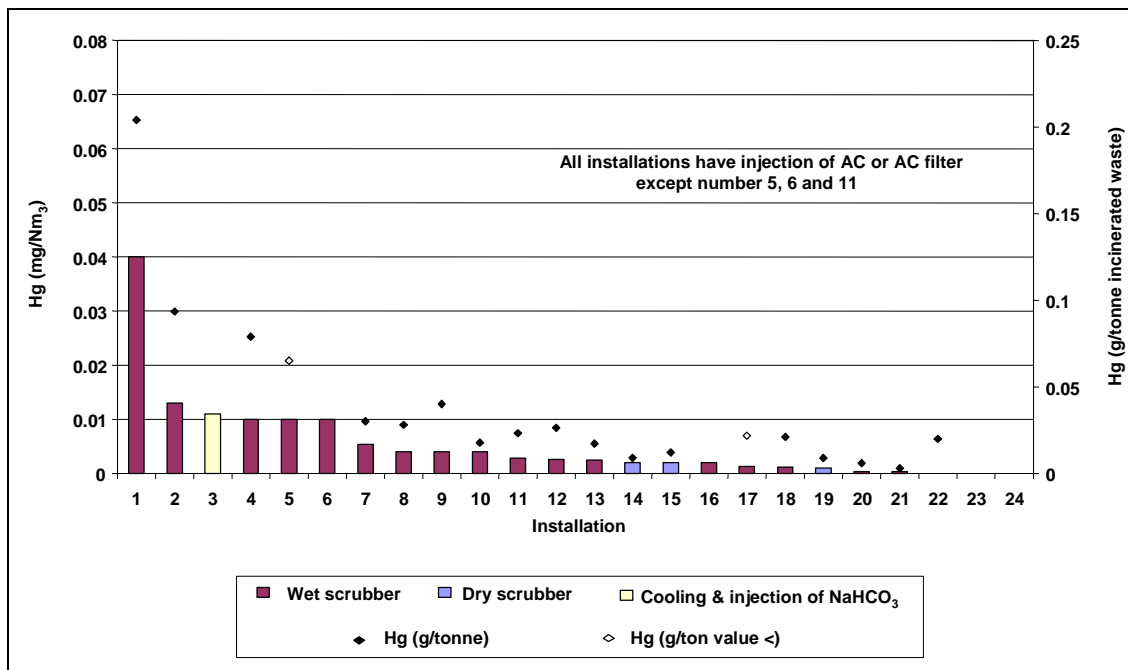

**Figure 3.5: Graph of Hg annual average emissions to air and applied abatement technique at European HWIs**  
Source [41, EURITS, 2002]

General conclusions from the graph:

- 90 % of the installations perform below 0.01 mg/Nm<sup>3</sup>
- for the 3 other installations the emissions are 0.06, 0.04 and 0.013 mg/Nm<sup>3</sup> respectively.

Although not shown in these results, practical experience is that the type of activated carbon (physical characteristics and the impregnation of the carbon) has an influence on Hg removal efficiency.

#### Other metals: Sum of As, Sb, Pb, Cr, Co, Cu, Mn, Ni, V, Sn

In the graph below, the yearly average metal emissions for all installations are given. These values are given as:

- the average concentration of the sum of the metals in mg/Nm<sup>3</sup>, 11 % O<sub>2</sub>, dry and standard conditions
- the average mass flow of the sum of the metals in g/t incinerated waste.

For most installations this shows an average concentration of two to eight discontinuous measurements a year. These measurements are performed based on the US Environmental Protection Agency (EPA) Method 29.

Over 60 % of the installations perform under 0.2 mg/Nm<sup>3</sup>.

#### Detection limit reporting differences:

The key potential difference in reported values is partly a result of the manner of reporting of undetected metals. In some countries these metals are calculated as zero, in other countries the detection limit values of the metals are reported.

The detection limit of the analysed metals depends on the total amount of sample taken and on the type of metal analysed (detection limits up to 0.018 mg/Nm<sup>3</sup> for some metals are reported).

In other countries one detection limit value (0.001 or 0.005 mg/Nm<sup>3</sup>) for all metals is reported, independent of the type of metal or the amount of sample taken.

Taking account of the detection limit value of the undetected metals, results in the reporting of a much higher sum value of the ten reported metals.

As a result only the data equal to or higher than 0.05 mg/Nm<sup>3</sup> are shown in the graph and the results below 0.05 mg/Nm<sup>3</sup> are indicated as less than 0.05 mg/Nm<sup>3</sup>.

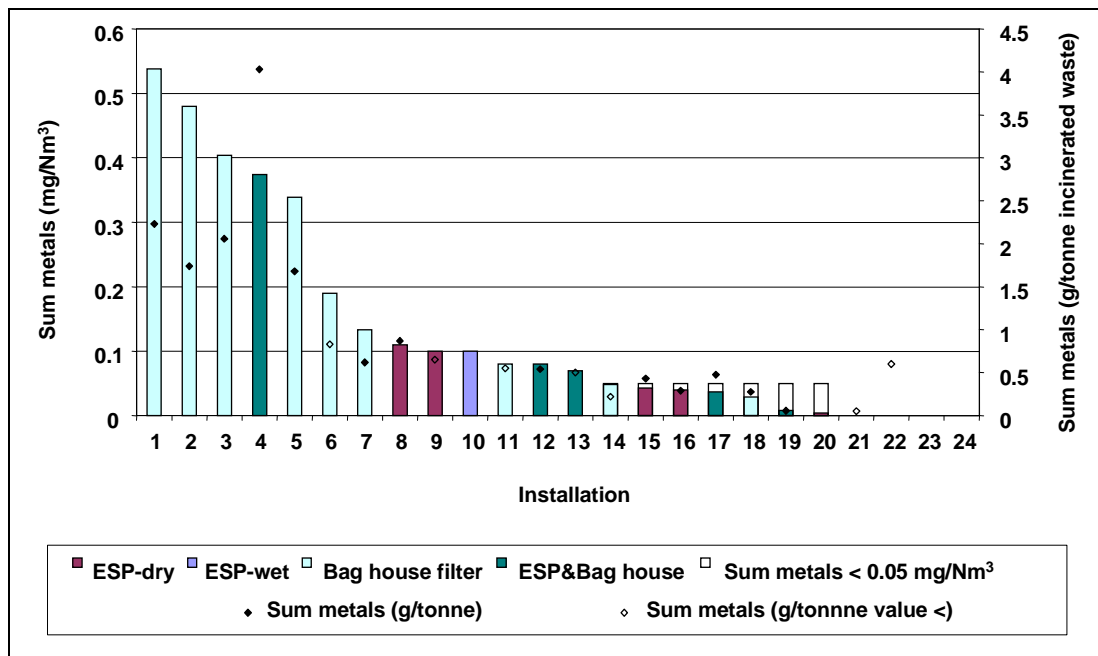

**Figure 3.6: Annual average emissions to air of other metals and applied abatement technique at European HWIs**  
Source [41, EURITS, 2002]

General conclusions from the graph:

- 63 % of the installations perform below 0.2 mg/Nm<sup>3</sup> and for these installations there is no direct relationship with the abatement technique that is installed
- the other five installations, all equipped with a bag-house filter, have a higher metal emission.

### Cadmium and thallium

In the graph below, the yearly average metal emissions for all installations are given. These values are given as:

- the average concentration of the sum of Cd and Tl in mg/Nm<sup>3</sup>, 11 % O<sub>2</sub>, dry and standard conditions.

For most installations this shows an average concentration of two to eight discontinuous measurements a year. These measurements are performed based on the US Environmental Protection Agency (EPA) Method 29.

75 % of the installations perform under 0.02 mg/Nm<sup>3</sup>. The key potential difference in reported values is partly a result of the different way of treatment of undetected metals as discussed in the paragraph on *other metals* (above). Using the detection limit value of the undetected metals results in a higher sum value of the reported metals. As a result, only the data equal to or higher than 0.01 mg/Nm<sup>3</sup> are shown in the graph and the results below 0.01 mg/Nm<sup>3</sup> are indicated as less than 0.01 mg/Nm<sup>3</sup>.

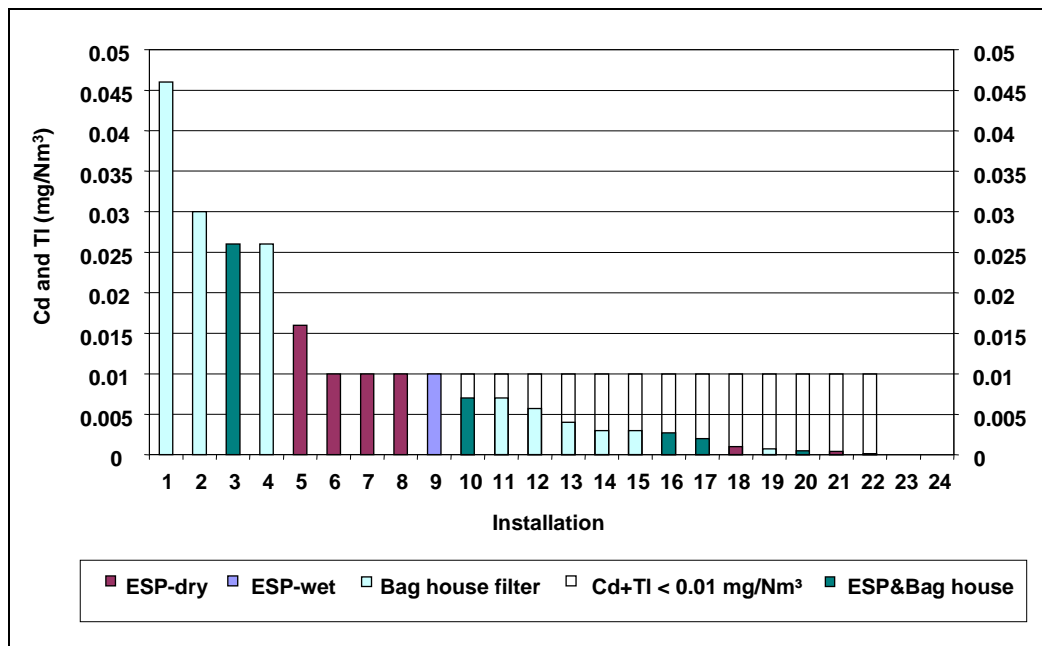

**Figure 3.7: Graph of Cd and TI annual average emissions to air and applied abatement technique at European HWIs [41, EURITS, 2002]**

### Dioxins and furans

In the graph below, the data for polychlorinated dibenzo-dioxins (PCDD) and polychlorinated dibenzofurans (PCDF) for all surveyed installations are given. These are given as average concentrations expressed as TEQ ng/Nm<sup>3</sup>, 11 % O<sub>2</sub>, dry and standard conditions. For most installations, it shows an average of two to four discontinuous measurements a year (based on CEN: EN1948).

#### Detection limit differences:

Between the official laboratories which are certified for the determination of dioxins, there is a large difference in the reporting of the attainable detection limit of the analytical method. It ranges from 0.01 to less than 0.001 ng TEQ/Nm<sup>3</sup>, notwithstanding the fact that comparable sampling procedures are followed (e.g. 6 - 8 hour sampling period). The lowest detection limits are reported by German laboratories.

Here, only the data equal or higher than 0.01 ng TEQ/Nm<sup>3</sup> are shown in the graph and the results below 0.01 ng TEQ/Nm<sup>3</sup> are indicated as less than 0.01 ng TEQ/Nm<sup>3</sup>.

The key potential difference in reported values is possibly a result of the inconsistent treatment of undetected PCDD/PCDF isomers some being calculated at the LOD (EN 1948 pt 3 refers), others being calculated as zero. The relative influence of the variation therein, is the function merely of the respectively assigned toxic equivalence factor (TEF) for that isomer.

From the graph, no specific conclusion can be drawn regarding the performance of the different techniques, as the ranking of the results is not directly related to the type of abatement technique installed. The low emission values and the variable accuracy of the analytical measurements at this level are additional confounding factors. Monitoring results from plants using continuous sampling show similar levels as short period monitoring.



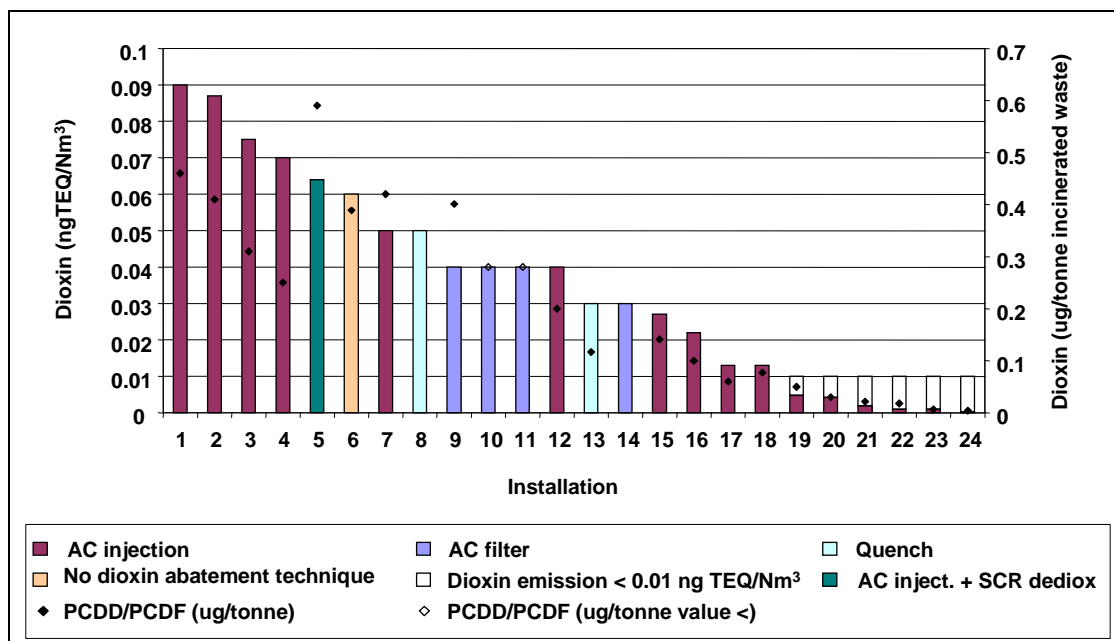

**Figure 3.8: Graph of PCDD/F annual average emissions to air and applied abatement technique at European HWIs [41, EURITS, 2002]**

### PCBs and PAHs

The emission of Poly-Chlorinated-Biphenyls (PCBs) is not always monitored. The available data show values mostly less than detection limit and ranging from  $<1 \mu\text{g}/\text{Nm}^3$  to  $<2 \text{ ng}/\text{Nm}^3$ . Here again, a critical analytical remark has to be made about the variability of the reported detection limits of the measurement methods.

The emission of Poly-Aromatic-Hydrocarbons (PAHs) is also not always monitored. The available data show values range from  $<1 \mu\text{g}/\text{Nm}^3$  to  $<0.1 \mu\text{g}/\text{Nm}^3$ . Here also, a critical analytical remark has to be made about the variability of the reported detection limits of the measurement methods.

### Carbon monoxide

Combustion efficiency is partly described by CO levels, which also indicates formation of also other Products of Incomplete Combustion (PICs).

The yearly average values for all installations surveyed, obtained as a result of continuous measurements vary from 3 to  $26 \text{ mg}/\text{Nm}^3$ .

CO is a typical parameter with a low baseline emission but which periodically shows sharp peak emissions, due to sudden variations in local combustion conditions (e.g. variations in temperature of parts of the kiln). The monitoring and control of these peak emissions is an important aspect of the daily operation of an incinerator. With the pretreatment of drummed waste and feed equalisation it is possible to decrease CO peaks.

Figure 3.9 below shows the reductions in CO emission achieved at an HWI following the introduction of drum shredding and other waste input blending techniques (technique described in Section 2.2.2.4 and Figure 2.2):

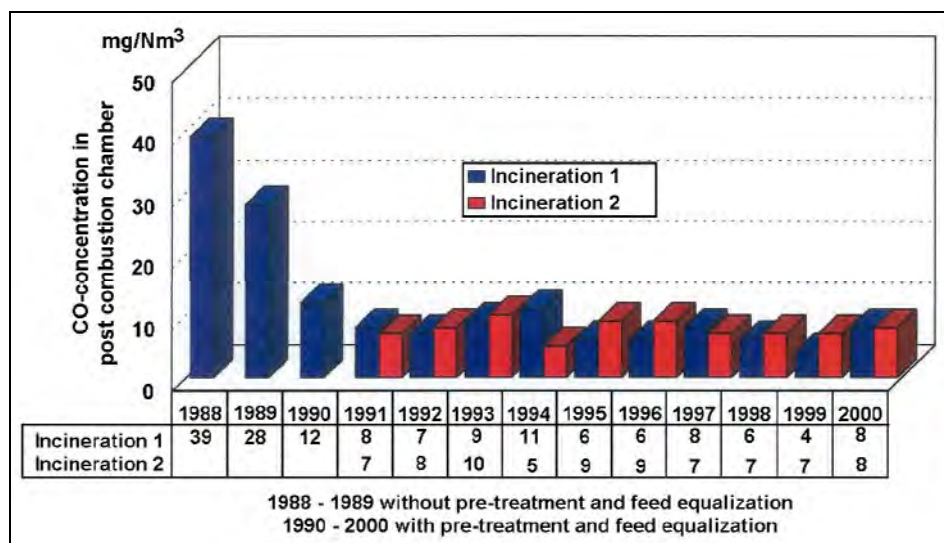

Figure 3.9: CO emission reductions achieved following introduction of pretreatment techniques at a hazardous waste incinerator [20, EKOKEM, 2002]

### 3.3 Emissions to water

#### 3.3.1 Volumes of waste water arising from flue-gas treatment

[1, UBA, 2001]

Water is used in waste incineration for various purposes. Wet flue-gas cleaning systems give rise to waste water whereas semi-wet and dry systems generally do not. In some cases the waste water from wet systems is evaporated and in others it is treated and discharged.

Table 3.23 shows examples of the typical quantities of scrubbing water arising from the flue-gas cleaning of waste incineration plants.

Plant type and waste throughput	Type of flue-gas cleaning	Approx. quantity of waste water (m <sup>3</sup> /tonne waste)
Municipal waste incineration plant with a throughput of 250000 t/yr	2 stages, with milk of lime	0.15 (design value)
Municipal waste incineration plant with a throughput of 250000 t/yr	2 stages, with sodium hydroxide (before condensation facility)	0.3 (operating value)
Hazardous waste incineration plant with a throughput of 60000 t/yr	2 stages, with milk of lime	0.15 (annual average)
Hazardous waste incineration plant with a throughput of 30000 t/yr	2 stages, with sodium hydroxide	0.2 (annual average)

Table 3.23: Typical values of the amount of scrubbing water arising from FGT at waste incineration plants treating low chlorine content wastes

[1, UBA, 2001]

### 3.3.2 Other potential sources of waste water from waste incineration plants

[1, UBA, 2001]

Besides the waste water from the flue-gas cleaning, waste water can also arise from a number of other sources. Regional rainfall variations can have a great effect. Owing mainly to differences on installation design, not all of these waste water streams will arise at all plants and those given here are streams which may arise:

Waste water	Approx. amount	Occurrence
Chimney condensates after wet scrubbing	<ul style="list-style-type: none"> <li>• 20 m<sup>3</sup>/d</li> <li>• 6600 m<sup>3</sup>/yr</li> </ul>	(c) continuous
Wet ash removing/wet declining	<ul style="list-style-type: none"> <li>• 5 m<sup>3</sup>/d</li> <li>• 1650 m<sup>3</sup>/yr</li> </ul>	c
Reversible flow water from ion exchanger	<ul style="list-style-type: none"> <li>• 1 m<sup>3</sup>/4 weeks</li> <li>• 120 m<sup>3</sup>/yr</li> </ul>	(d) discontinuous
Boiler water	<ul style="list-style-type: none"> <li>• 500 m<sup>3</sup>/yr</li> </ul>	d
Water from the cleaning of storage containers	<ul style="list-style-type: none"> <li>• 800 m<sup>3</sup>/yr</li> </ul>	d
Other cleaning water	<ul style="list-style-type: none"> <li>• 300 m<sup>3</sup>/yr</li> </ul>	d
Contaminated rainwater	<ul style="list-style-type: none"> <li>• 200 m<sup>3</sup>/yr (Germany)</li> </ul>	d
Laboratory water	<ul style="list-style-type: none"> <li>• 200 m<sup>3</sup>/yr</li> </ul>	d

Data calculated on the basis of 330 operating days per year

**Table 3.24: Other possible waste water sources, and their approximate quantities, from waste incineration plants**

[1, UBA, 2001]

### 3.3.3 Installations free of process water releases

[1, UBA, 2001]

In some incineration plants waste water arising from wet gas scrubbing is evaporated in the incineration process using a spray dryer. This can eliminate the need for effluent releases from the process.

In such cases the waste water is generally pretreated in an Effluent Treatment Plant (ETP), before it is fed to the spray dryer. Treatment in an ETP can help to prevent the recirculation and accumulation of some substances. Hg recirculation is of particular concern, and specific reagents are usually added to provide a means for Hg removal from the system.

Salt (NaCl) can be recovered from the treated effluent for possible industrial uses, or may be collected in the FGT residues.

### 3.3.4 Plants with physico-chemical waste water treatment

[1, UBA, 2001]

The treatment of waste water from the flue-gas cleaning in waste incineration plants is not fundamentally different from the treatment of waste water from other industrial processes.

Waste water from municipal waste incineration plants mainly contains the following substances, which require treatment:

- heavy metals, including mercury
- inorganic salts (chlorides, sulphates etc.)
- organic compounds (phenols, PCDD/PCDF).

The following table shows typical contamination levels of waste water from flue-gas cleaning facilities of municipal and hazardous waste incineration plants before the treatment of waste water.

Parameter	Municipal waste incineration			Hazardous waste incineration for common commercial plants		
	Minimum	Maximum	Average	Minimum	Maximum	Average
pH Value	<1		n/a	<i>No data</i>	<i>No data</i>	n/a
Conductivity (µS)		>20000		<i>No data</i>	<i>No data</i>	
COD mg/l)	140	390	260	<i>No data</i>	<i>No data</i>	22
TOC mg/l)	47	105	73	<i>No data</i>	<i>No data</i>	
Sulphate mg/l)	1200	20000	4547	615	4056	
Chloride mg/l)	85000	180000	115000	<i>No data</i>	<i>No data</i>	
Fluoride mg/l)	6	170	25	7	48	
Hg (µg/l)	1030	19025	6167	0.6	10	
Pb mg/l)	0.05	0.92	0.25	0.01	0.68	
Cu mg/l)	0.05	0.20	0.10	0.002	0.5	
Zn mg/l)	0.39	2.01	0.69	0.03	3.7	
Cr mg/l)	<0.05	0.73	0.17	0.1	0.5	
Ni mg/l)	0.05	0.54	0.24	0.04	0.5	
Cd mg/ l)	<0.005	0.020	0.008	0.0009	0.5	
PCDD/PCDF (ng/l)	<i>No data</i>	<i>No data</i>	<i>No data</i>	<i>No data</i>	<i>No data</i>	<i>No data</i>

**Table 3.25: Typical contamination of waste water from wet FGT facilities of waste incineration plants before treatment [1, UBA, 2001]**

The following two tables show:

- Table 3.26 shows the annual specific emissions to surface water and/or sewer from various waste incinerators in the Netherlands in 1999.
- Table 3.27 shows the impact of waste water treatment on the effluent from a MSWI and provides a comparison of this performance with various standards.

Site	Incinerated	As	Cd	Cr	Cu	Hg	Pb	Ni	Zn	Chlorides	Sulphates	COD	N-Kjeldahl
	(kt/yr)	mg/t	mg/t	mg/t	mg/t	mg/t	mg/t	mg/t	mg/t	(g/t)	(g/t)	(g/t)	(g/t)
<b>Municipal Waste Incineration</b>													
Gevudo	171	23.2	9.1	17	115	3.04	72	39.9	552	4990	2070	298	46
AVR Rotterdam	386	0.5	0.3	5	6	0.10	9	8.6	4	n/a	n/a	15	1
AVR-Botlek	1106	0.6	2.7	2	4	0.72	5	2.1	20	n/a	n/a	34	4
AVR AVIRA	301	0.0	2.0	2	6	0.07	2	1.6	26		0	133	10
AVI Roosendaal	55	4.4	0.1	7	62	0.02	16	4.9	45	0	0	24	1
ARN	250	3.7	1.3	43	25	0.71	23	44.4	181	708	111	207	131
AVI Amsterdam	789	0.0	0.0	0	0	0	0	0	0		0	0	0
AVI Noord-	452	0.1	0.1	1	3	0.02	4	0.4	27	1	n/a	n/a	n/a
AVI Wijster	433	23.1	0.0	30	58	0.16	53	36.9	226	335	84	380	44
AZN	603	0.2	0.2	0	2	0.17	0	0.3	23	4602	254	18	4
AVI Twente	285	n/a	0.0	0	0	n/a	0	0.0	1	2	n/a	12	1
<b>Hazardous Waste Incineration</b>													
AVR-Chemie DTs	44	4.6	4.6	14	25	6.84	23	18.3	228	n/a	n/a	319	26
<b>Clinical Waste Incineration</b>													
ZAVIN	7	191.1	632.1	658	2694	4391.27	11676	459.0	72832	n/a	n/a	658	16
<b>Sewage Sludge Incineration</b>													
DRSH	368	21.4	3.5	5	79	5.97	15	3.0	92	1561	4560	1829	n/a
SNB	406	5.8	0.6	18	17	1.23	8	12.3	51	725	31	816	768
V.I.T.	89	1.9	1.5	3	14	0.51	19	6.0	56	n/a	56083	155	30

**Table 3.26: Releases to surface water and sewers from Dutch waste incinerators in 1999**  
[2, infomil, 2002]

Contaminant	Waste water															
	Limit values			Input			Treated effluent (Trimercaptotriazine add. 150 ml/m <sup>3</sup> )			Input			Treated effluent (Trimercaptotriazine add. 55 ml/m <sup>3</sup> )			
				First stage wet scrubber 289 l/t waste input						Second stage scrubber 55 l/t waste input						
			German 33Abw mg/l	EC Dir. 2000/76 mg/l	Range		Avg. mg/l	Range		Avg. mg/l	Range		Avg. mg/l	Range		Avg. mg/l
					Min. mg/l	Max. mg/l		Min. mg/l	Max. mg/l		Min. mg/l	Max. mg/l		Min. mg/l	Max. mg/l	
pH				0.3	0.6	0.5	6.7	8.3	7.6	7.4	8.4	8.1	9.4	11.1	10.3	
Susp. solids	95 %	30	30										1	56 (1)	23.8	
	100 %	45	45										1	56 (1)	23.8	
Hg		0.03	0.03	1.8	5.7	3.6	<0.001	0.013	0.01	0.04	1.42	0.82	<0.001	0.013	<0.003	
Cd		0.05	0.05	<0.01	0.76	0.45	<0.01	<0.01	<0.01	0.1	0.62	0.37	<0.01	0.02	<0.01	
Tl		0.05	0.05	<0.01	0.03	0.028	<0.01	0.013	<0.01	<0.01	0.02	0.016	<0.01	0.023	<0.013	
As		0.15	0.15	<0.03	0.1	0.05	<0.05	<0.05	<0.05	<0.05	0.08	0.06	<0.03	<0.10	<0.04	
Pb		0.1	0.2	1.2	24	8.8	0.03	1.2	0.13	0.7	9.2	3.5	<0.05	1.4 (2)	<0.11	
Cr		0.5	0.5	0.46	1.3	0.7	<0.02	<0.02	<0.02	0.02	0.14	0.06	<0.02	0.03	<0.02	
Cu		0.5	0.5	1.9	29	8.6	0.1	0.32	0.23	0.81	3.1	1.4	0.02	0.79 (3)	0.10	
Ni		0.5	0.5	1.9	4.5	2.5	0.23	0.64	0.41	0.02	0.13	0.08	<0.02	0.83 (4)	<0.20	
Zn		1.0	1.5	4.1	67	24	0.17	0.25	0.22	6.9	36	17	0.01	1.7 (5)	0.19	
Dioxin	ng/l	0.3	0.3	In liquids		0.01			<0.01			<0.01			<0.01	
Dioxin	ng/l			In solids		11.7			0.25			15.9			0.32	

Notes:

- 1 in excess of 24 measurements in 2001
- 5 in excess of 104 measurements 0.18 – 0.27 (1 x 1.4) mg/l in 2001
- 2 in excess of 104 measurements 0.66 and 0.79 mg/l in 2001
- 3 in excess of 104 measurements 0.57- 0.83 mg/l in 2001
- 1 in excess of 104 measurements in 2001

**Table 3.27: Waste water quality (after treatment with Trimercaptotriazine) - Comparison between raw and treated waste water and various standards [52, Reimann, 2002]**

### 3.3.5 Hazardous waste incineration plants - European survey data

[EURITS, 2002 #41]

The data in this section describe the emissions to water arising from treated flue-gas waste water streams. The data are taken from a survey of European merchant hazardous waste incinerators as reported by [EURITS, 2002 #41].

#### 3.3.5.1 General overview of emissions to water from European HWI

An overview of the yearly average minimum and maximum concentrations for the different installations is given in Table 3.28.

The concentration of most parameters varies a lot between the different installations, as does the water flow (expressed in litre per kilogram of waste incinerated).

Parameter all mg/l (unless stated)	Yearly average	
	Minimum	Maximum
Suspended solids	3	60
COD	<50	<250
Cd	0.0008	0.02
Tl	0.01	0.05
Hg	0.0004	0.009
Sb	0.005	0.85
As	0.0012	0.05
Pb	0.001	0.1
Cr	0.001	0.1
Co	<0.005	<0.05
Cu	0.01	0.21
Mn	0.02	0.2
Ni	0.004	0.11
V	<0.03	0.5
Sn	<0.02	<0.5
Zn	<0.02	0.3
Cl <sup>-</sup>	3000	72000
SO <sub>4</sub> <sup>2-</sup>	300	1404
Dioxins (ng TEQ/l)	0.0002	<0.05
Flow of water (l/kg waste)	0.2	20

**Table 3.28: Annual average range of concentrations of the emissions to water after treatment from merchant hazardous waste installations that discharge waste water**  
[EURITS, 2002 #41]

Table 3.29 below shows the emissions to water as the mass flow of these components in mg/kg of waste input:

Parameter	mg/kg waste incinerated)	
	Minimum	Maximum
Suspended solids	2.4	325
COD	76.5	1040
Cd	0.001	0.16
Hg	0.00048	0.112
Sb	0.0325	0.72
As	0.001	0.325
Pb	0.0084	0.65
Cr	0.0024	2
Co	0.045	0.325
Cu	0.0085	4.2
Mn	0.023	1
Ni	0.0042	2
V	0.325	0.6
Sn	0.09	0.565
Zn	0.0226	1.95
Cl	4520	60000
SO <sub>4</sub> <sup>2-</sup>	240	6572

**Table 3.29: Mass flows of the emissions to water from surveyed merchant HWIs in Europe [EURITS, 2002 #41]**

### 3.3.5.2 Overview by parameter of emissions to water from European HWI

#### Suspended solids

In the graph below, the yearly average values for suspended solids released for all of the surveyed installations are given as suspended solids in mg/l effluent.

For each installation the type of waste water treatment technique effective for suspended solids is shown; these are:

- the use of a sand filter
- the separate treatment of the acidic and alkali scrubber waters - in this case no forced precipitation, nor post precipitation of CaSO<sub>4</sub> is performed, and higher loads of sulphate are discharged
- no additional water treatment step.

From the graph on heavy metals (Figure 3.6) it can be seen that these metals are only a marginal constituent of the suspended solids.

For the origin of the residual suspended solids in the effluent which is discharged, three scenarios can be given:

- residual fractions of the precipitated components which are not removed by decantation or filtration
- when groundwater containing Fe(II) is used in wet flue-gas cleaning, a slow oxidation of Fe(II) to Fe(III) and subsequent precipitation of Fe(OH)<sub>3</sub> can result in suspended solids where the residence time in the waste water treatment plant is shorter than the time the reaction needs to be completed
- in other cases, the suspended solid can originate from post precipitation reactions of sulphates and carbonates with Ca<sup>2+</sup> which is present in the effluent or in other water streams which come into contact with the effluent before discharge and when the residence time is shorter than the time the reaction needs to be completed.



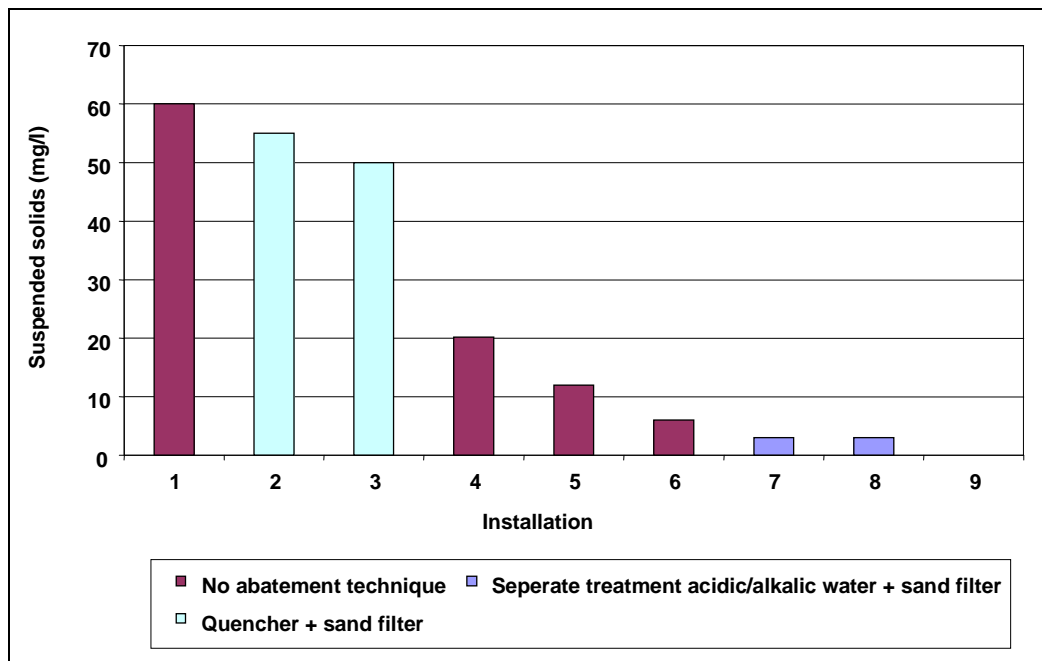

**Figure 3.10: Graph of annual average suspended solid discharges to water and applied abatement technique at European HWIs [EURITS, 2002 #41]**

General conclusions from the graph:

- all the installations perform below 60 mg/l
- the installations that have separate treatments for the acidic and alkali scrubber waters achieve the lowest emissions of suspended solids (3 mg/l).

### Mercury

In the graph below, the yearly average mercury values for all installations are given. And given as:

- the average concentration in mg/l, for 24 hour representative samples for continuous discharge (90 % of installations) or for batch representative samples for batch discharge (10 % of installations)
- the 95 percentile in mg/l, if daily values or several values a week are available
- the 99 percentile in mg/l, if daily values or several values a week are available.

For five of the waste water streams, Hg is measured daily (or several times a week) and for four installations data are obtained weekly or monthly. It can be concluded that the data in the graph are representative of a complete working year.

For each installation the type of waste water treatment technique is shown, so far as it has an influence on mercury emissions. In this case, there is:

- the precipitation of mercury as a M-sulphide or a M-trimercaptotriazine component
- the precipitation as M-sulphide component and subsequently the use of an activated carbon filter
- no additional water treatment step.

Mercury in the effluent originates, of course, from mercury contained in the waste. It is common practice that incinerators apply an input limit for mercury over a time period.

For one installation equipped with wet gas scrubbing, it is calculated that the total mercury input via the waste, amounts to 2000 kg/yr for an installation with an incineration capacity of 100000 t/yr. Taking into account a maximum yearly emitted Hg flow via the waste water of less than 4 kg/yr, a removal efficiency higher than 99.8 % can be reached based on M-trimercaptotriazine precipitation and subsequent efficient removal of the precipitate.

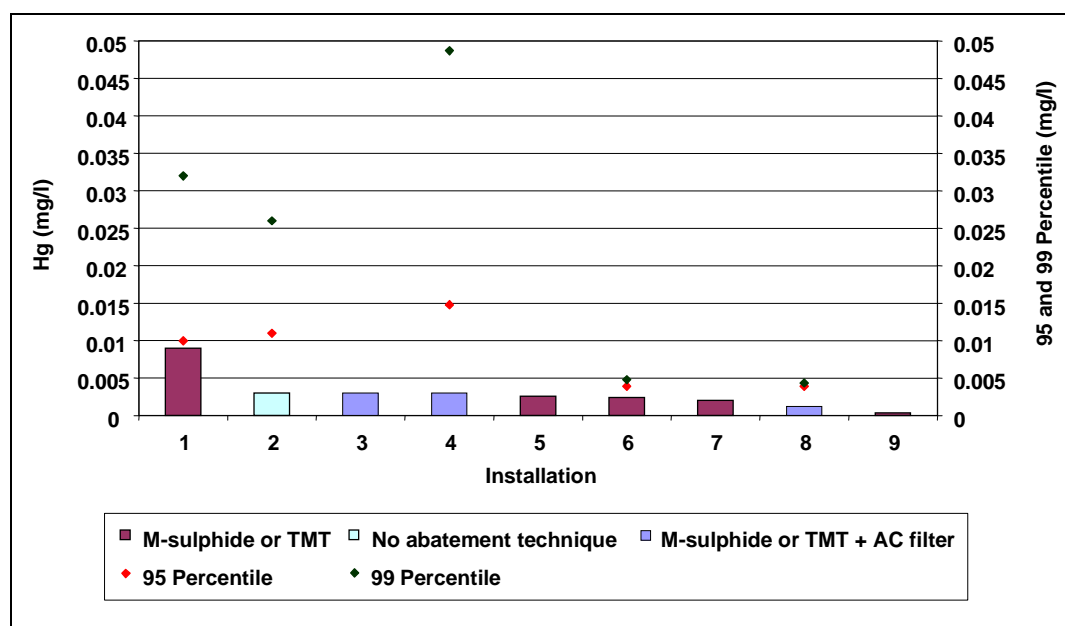

Figure 3.11: Graph of annual average mercury discharges to water and applied abatement technique at European HWIs [EURITS, 2002 #41]

General conclusions from the graph:

- all the installations perform below 0.01 mg/l
- the 95 and 99 percentile values vary from one installation to another
  - in three cases occasional peak values of Hg are detected (average <P95 <P99) which can amount to 50 µg/l and higher; the reason for this is unexpected situations, e.g. unexpectedly high input or failures of the treatment installation
  - in two cases no peak values are detected (P99= P95 = average); the reason for this is in one case that discharges are made periodically and not continuously, and in the other case the fact that no Hg is present in the raw alkaline scrubber water
- there is no direct relationship visible between the abatement technique and the annual average emission of mercury.

### Metal emissions

In the graph below the yearly average metal emissions for all installations are given and given as:

- average concentrations in mg/l, for 24 hour representative samples in the case of continuous discharges (90 % of installations) or for batch representative samples in the case of batch discharges (10 % of installations)
- the 95 percentile in mg/l, if daily values or several values a week are available
- the 99 percentile in mg/l, if daily values or several values a week are available.

The waste water treatment technique used to decrease the metal emissions consists of precipitation of metals as hydroxides and/or as metal sulphide components. Flocculation additives are used to optimise the precipitation.

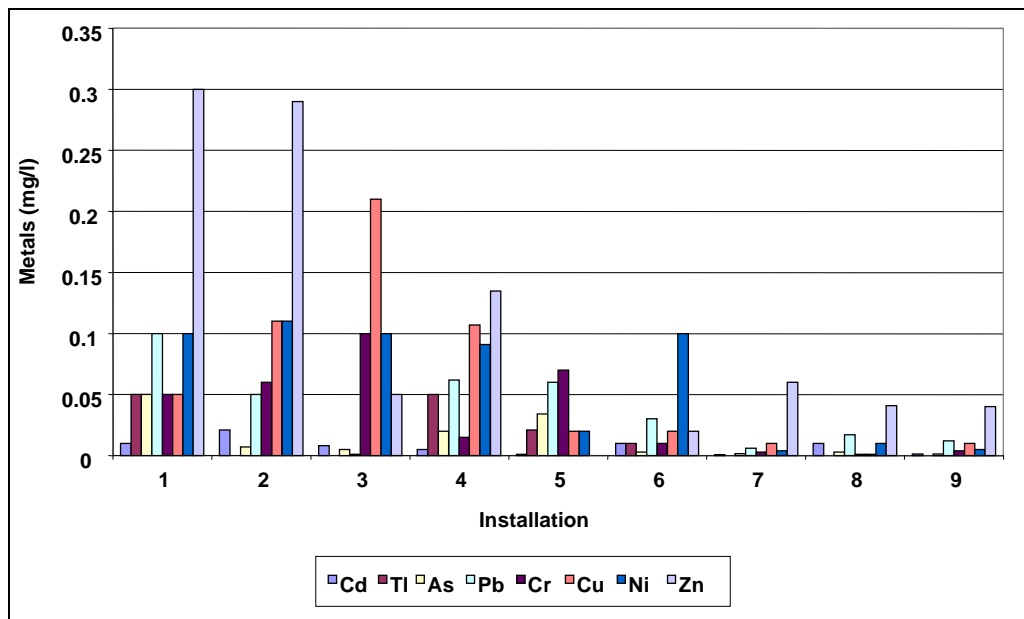

Figure 3.12: Graph of annual average discharges of various metals to water at European HWIs [EURITS, 2002 #41]

General conclusions from the graph:

- almost all the individual metal emissions are below 0.1 mg/l
- only higher values are registered for Zn and Cu in specific cases.

In the following graphs a more detailed overview is given per parameter with 95- and 99-percentile values. From these graphs it can be seen that, in some cases, higher values are sometimes registered.

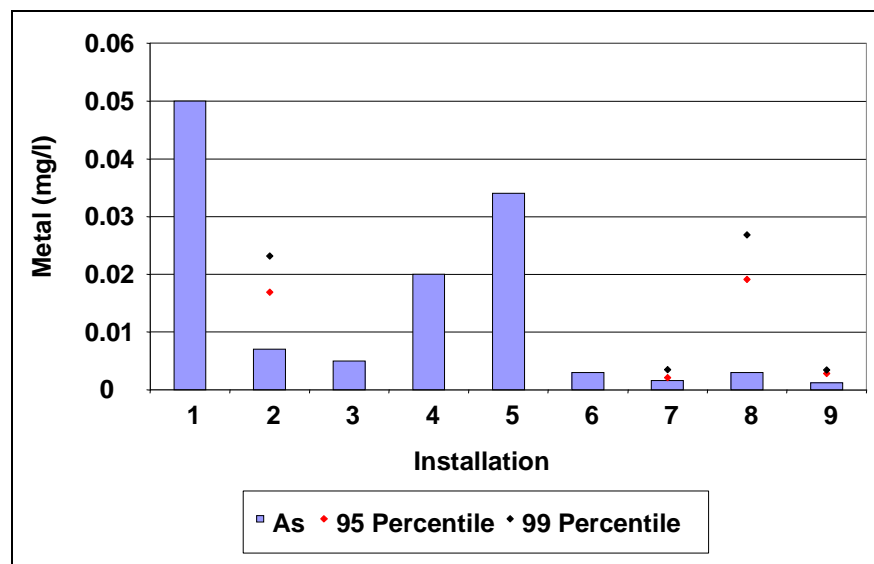

Figure 3.13: Graph of annual average Arsenic discharges to water at European HWIs [EURITS, 2002 #41]

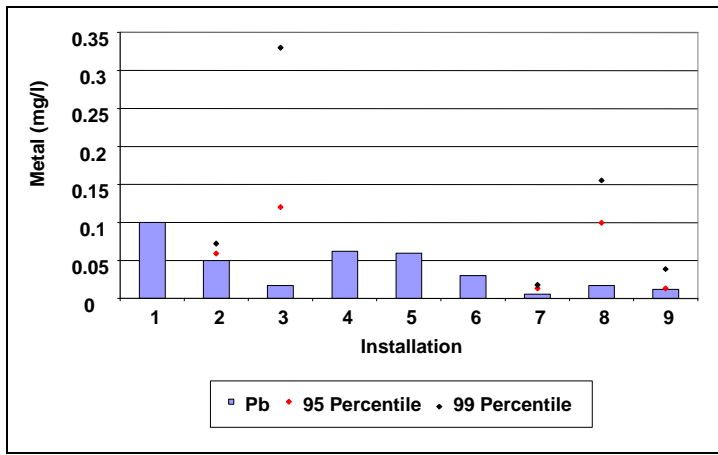

Figure 3.14: Graph of annual average lead discharges to water at European HWIs [EURITS, 2002 #41]

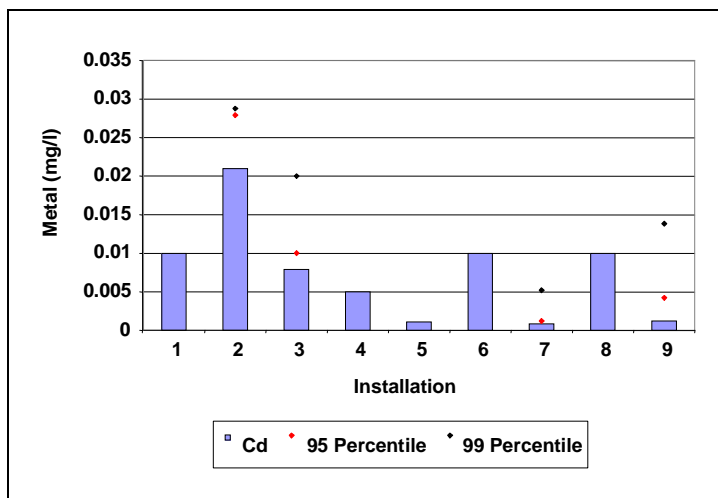

Figure 3.15: Graph of annual average Cadmium discharges to water at European HWIs [EURITS, 2002 #41]

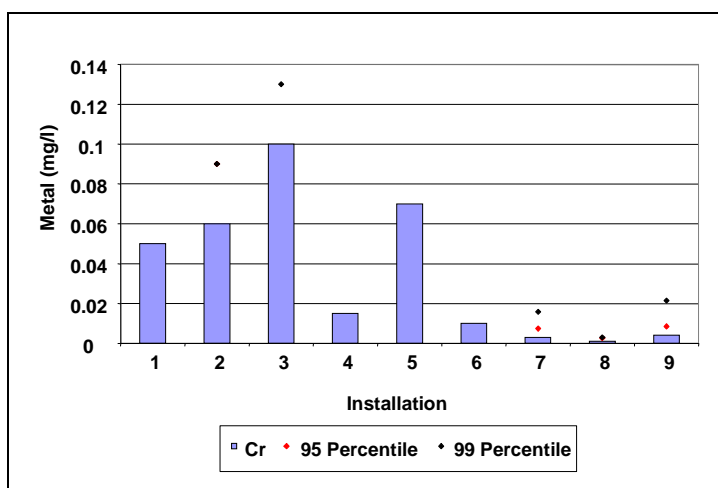

Figure 3.16: Graph of annual average Chromium discharges to water at European HWIs [EURITS, 2002 #41]

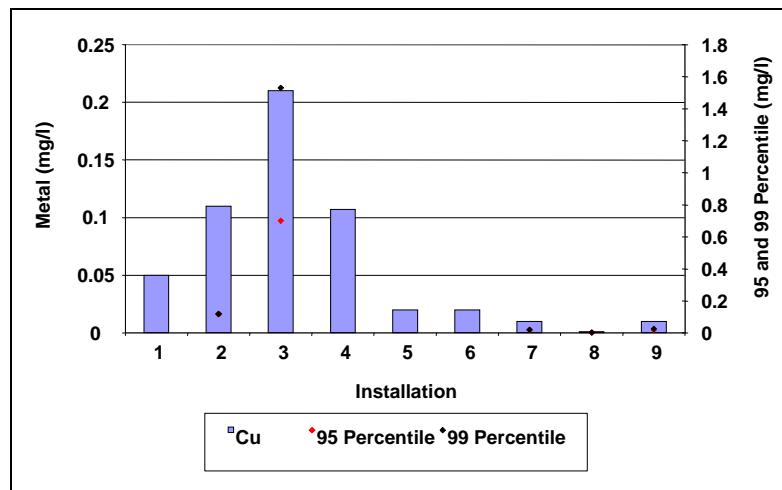

Figure 3.17: Graph of annual average Copper discharges to water European HWIs [EURITS, 2002 #41]

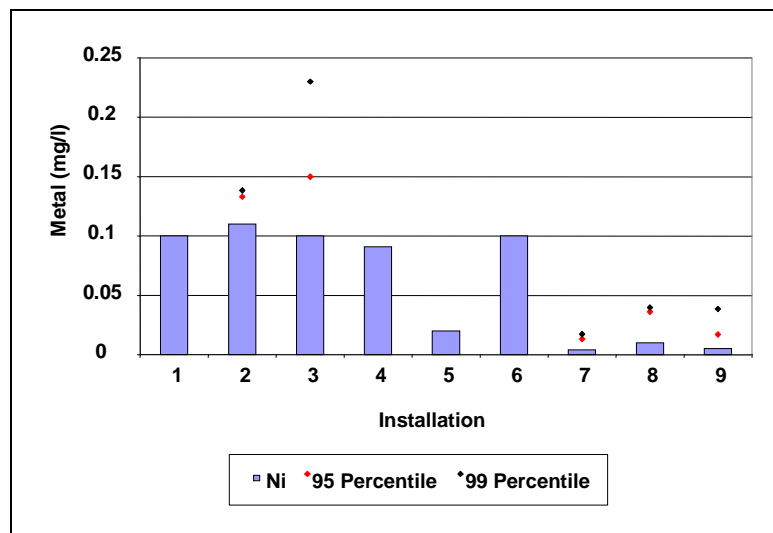

Figure 3.18: Graph of annual average Nickel discharges to water at European HWIs [EURITS, 2002 #41]

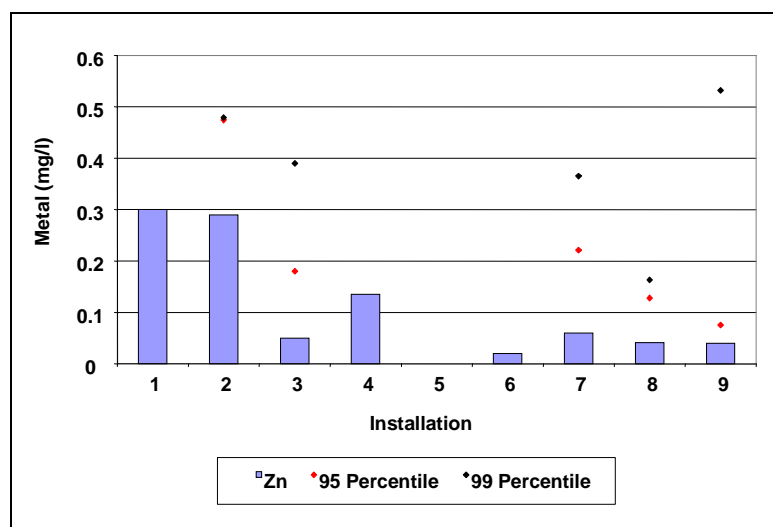

Figure 3.19: Graph of annual average Zinc discharges to water at European HWIs [EURITS, 2002 #41]

## Chloride and sulphate content

[EURITS, 2002 #41] The amount of **chloride** in the effluent demonstrates a linear relationship to the amount of chlorine in the waste in the input to the incinerator. Most incinerators discharge their waste water into, or near, the sea. A concentration of 3 - 72 g/l of effluent is quoted.

One surveyed installation discharges the effluent containing salt into the fresh water of a river.

The **sulphate** content in the effluent is controlled in most installations by the partial precipitation of gypsum, so the discharged concentration of  $\text{SO}_4^{2-}$  is between 1 and 2 g/l.

There is one installation which treats the acidic and alkali scrubber waters separately, without precipitation of gypsum, leading to a higher load of sulphate, discharged to the sea in this case.

## 3.4 Solid residues

### 3.4.1 Mass streams of solid residues in MSWI

In Table 3.30, some typical data on residues from municipal waste incineration plants are summarised:

Types of waste	Specific amount (dry) (kg/t of waste)
Slag/ash (including grate siftings/riddlings)	200 – 350
Dust from boiler and de-dusting	20 – 40
FGC residues, reaction products only:	
Wet sorption	8 – 15
Semi-wet sorption	15 – 35
Dry sorption	7 – 45
Reaction products, and filter dust, from:	
Wet sorption	30 – 50
Semi-wet sorption	40 – 65
Dry sorption	32 – 80
Loaded activated carbon	0.5 – 1
Note: wet sorption residue has a specific dryness (e.g. 40 – 50 % d.s.) [74, TWGComments, 2004]	

**Table 3.30: Typical data on the quantities of residues arising from municipal waste incineration plants.**

[1, UBA, 2001]

State-of-the-art MSWI plants typically produce between 200 and 350 kg bottom ashes per tonne of waste treated. Most published numbers include the grate siftings, which only recently (and only in some countries) have been kept separate from the bottom ash. The mass flow of siftings depends on the type of grate and its time of operation. The siftings may increase the amount of unburned matter in the bottom ash and can contribute to leaching of copper. Concerning bottom ash re-use, ferrous and non ferrous materials (e.g. Al) may be segregated. However, the inventory of metallic Al, which drips through the grate voids, is of higher concern (e.g. can cause grate blockage) [74, TWGComments, 2004]

The production of boiler ash depends on the type of boiler and on the amount of dust originally released from the grate.

[Vehlow, 2002 #38] The mass flow of flue-gas treatment residues shows the highest variation of all residues. 10 – 12 kg/t is a mean value for wet systems, which operate close to stoichiometry. This figure comprises the dry neutral sludge (2 – 3 kg/t) and the soluble salts (8 – 9 kg/t). In semi-wet or dry lime systems the amount is increased because of unreacted additives, while the dry sodium bicarbonate process gives the lower values [64, TWGComments, 2003].

Table 3.31 below, gives mass streams of solid residues for various substances per tonne of MSW incinerated. The data given is average data for 12 MSWI in the Flanders Region of Belgium in 1999:

Type of solid residue	Percentage (%)
Bottom ash	21
Fly ash + gas cleaning residue + sludge from wet scrubbers	4.2
Scrap recuperated from bottom ash	1.2

**Table 3.31: Mass streams of solid residues from MSWI expressed per tonne of MSW incinerated [64, TWGComments, 2003]**

### 3.4.2 Bottom ash composition and leachability

Requirements concerning the quality of the residues from the incineration process are included in European incineration legislation. Directive 2000/76/EC (Art. 6.1) includes an operational condition requiring that incineration plants achieve a level of incineration such that, in slag and bottom ashes, the loss on ignition is  $\leq 5\%$  or the TOC is  $\leq 3\%$ . In modern well-operated MSWI plants the TOC in bottom ashes can be below 1 wt %. Combustion trials have demonstrated that an increase in heating value of the waste feed and resulting higher bed temperatures improve the burnout of bottom ash [Vehlow, 2002 #38]

Typical concentrations of organic compounds in the various solid residues are compiled in Table 3.32. Only data from modern facilities have been used in this table. TOC determination in accordance with the standard EN 13137 also detects elementary carbon as TOC, which does not cause any problems on landfills. The TOC of bottom ashes comprises mainly elementary carbon, but to a certain extent, organic compounds are also found (coming e.g. from sifting of plastics). These cover the spectrum from short-chain compounds up to low volatile species such as PAH or PCDD/F. The I-TEQ levels detected in the bottom ashes of modern incineration plants are in the same order of magnitude as those found in some urban and industrial soils.

Parameter	Bottom ash	Boiler ash	Filter ash
PCDD/F (I-TEQ)	<0.001 – 0.01	0.02 – 0.5	0.2 – 10
PCB	<5 – 50	4 – 50	10 – 250
PCBz	<2 – 20	200 – 1000	100 – 4000
PCPh	<2 – 50	20 – 500	50 – 10000
PAH	<5 – 10	10 – 300	50 – 2000
All values in ng/g			

**Table 3.32: Concentration ranges of organic compounds in bottom, boiler and filter ashes [Vehlow, 2002 #38]**

Table 3.33 below shows data for PCDD/F for 10 MSWI in Netherlands over 5 years (2000 - 2004):

Residue	Average value in ng/kg I-TEQ	Max value in ng/kg I-TEQ	Number of samples	Total amount in 2003/tonnes
Bottom ash	46	46	1	1100000
Fly ash	2946	16900*	34	82200
Boiler ash	42	86	3	2900
Wet FGC salts	636	5400	16	25500
Filter cake	17412	66000*	30	8300
* This is a relatively old installation with modern FGT-equipment that prevents dioxin emissions to air. The residue is land filled on a hazardous waste landfill site.				

**Table 3.33: PCDD/F concentrations in various MSWI incineration residues in NL (data 2000 – 2004)**

Table 3.34 below gives survey data of an overview of the PCDD/F content in residues from MSWI plants. The data excludes peak high and low results:

Residue	Range of values	units
Bottom ash	1 - 68	ng TEQ/kg dry solid
Boiler ash	<40 – 600	ng TEQ/kg dry solid
Fly ash (ESP)/filter dust	140 - 5720	ng TEQ/kg dry solid
Note: In this table the peak high and low values have been removed		

**Table 3.34: Range of PCDD/F concentrations in MSWI residues (excluding peak high and low values)**

The relative partitioning of elements into bottom ash depends mainly on the composition of the MSW fed to the incinerator, the volatility of the elements it contains, the type of incinerator and grate system applied and the operation of the combustion system. [4, IAWG, 1997]

The mass and volume reduction of waste incineration causes an enrichment of a number of heavy metals in the bottom ashes compared to their concentration in the waste feed. Some heavy metals, e.g. As, Cd, or Hg are, to a great extent, volatilised out of the fuel bed. It is evident that, with the exception of the mainly lithophilic Cu, all selected heavy metals are highly enriched in filter ashes.

Note: It is important to note that the risks associated with bottom ash are not indicated only by the presence or absence of substances – their chemical and physical form, as well as the nature of the environment where the material will be used is also important to prevent emissions from the ashes to the environment. [64, TWGComments, 2003] The important thing is, therefore, not the fact that the bottom ashes contain pollutants but to check possible emissions from the ashes to the environment.

Almost all regulations for the disposal or utilisation of waste products are based on standardised leaching tests. However, different tests are used in different countries. Harmonisation and standardisation of the testing procedures is under development within CEN (European Committee for Standardisation TC 292). Hence the testing is done under country specific conditions and the interpretation of the results of various tests has to take this into account.

Table 3.35 gives the average values for Dutch MSW incinerator bottom ash after mechanical treatment, as measured from 1993 to 1997. Data have been taken from regular quality controls performed by the national organisation of waste managers (VVAV) at all MSW incinerators and from the National Institute for Environmental Protection (RIVM).



Compound	Leaching value (mg/kg)
Sb	0.22
As	0.022
Ba	0.6
Cd	0.003
Cr	0.08
Co	0.05
Cu	3
Hg	0.001
Pb	0.07
Mo	1.52
Ni	0.13
Se	0.01
Sn	0.04
V	0.23
Zn	0.09
Br <sup>-</sup>	7.6
Cl <sup>-</sup>	2615
CN <sup>-</sup> (free)	0.01
CN <sup>-</sup> (total)	0.048
F <sup>-</sup>	14.1
(SO <sub>4</sub> ) <sup>2-</sup>	5058

**Table 3.35: Leaching properties of mechanically treated bottom ash, measured using NEN7343**

Leaching of bottom ashes can vary significantly depending on the type of waste. Recent values from a wide population of MSW indicates an average leaching for Cu of 5.79 mg/kg in 2001 and 6.21 mg/kg in 2002. [74, TWGComments, 2004]

As compared to stony or inert materials, the following compounds may be considered critical for MSW bottom ash: Cu, Zn, Sb, Mo, chloride, and sulphate. Treatment techniques aim to reduce the leachability of these critical compounds.

#### Residues from Hazardous waste incineration plants:

Residues from hazardous waste incineration are not fundamentally different from those of municipal waste incineration plants. However, the following differences can be observed:

- in the case of ash and slag: the incineration of hazardous waste in drums is usually performed at temperatures higher than those used for municipal waste incineration. This can result in different metal partitioning
- owing to variations in waste type and content, the specific amount of bottom ash can be subject to variations much greater than those in municipal waste incineration plants. These variations can be seen within the same plant according to the wastes fed, as well as between different plants and technologies
- in the case of filter dust/FGT residues, as the concentration of heavy metals is normally higher in hazardous waste, the solid residues produced may also contain considerably higher concentrations of heavy metals.

Table 3.36 below gives data from a European survey of merchant HWI operators concerning the total production of various residues:

	Residue production (kg/t waste input)			(Tonnes)
	Minimum	Maximum	Average	Total annual amount (recorded)
Bottom ash	83	246	140	193372
Boiler ash + fly ash + solid flue-gas cleaning residue	32	177	74	79060
Filter cake from ETP	9	83	30	16896

**Table 3.36: Quantities of the main waste streams produced by HWI (European survey data) [EURITS, 2002 #41]**

Typical leaching values for bottom ashes from hazardous waste incineration are given in Table 3.37. It must be noted that the German DIN-S4 leaching test was used, results are therefore given in mg/l. For comparison with the data from Table 3.35, approximate values in mg/kg may be obtained by multiplication by a factor of 10.

Compound	Minimum mg/l	Maximum mg/l
Cr (VI)	<0.03	2.87
Cr (total)	<0.001	2.87
As	<0.01	0.08
Pb	<0.01	0.18
Cu	<0.01	1.50
Hg	0.00	<0.01
Zn	<0.01	0.3
Cd	<0.001	0.001
Ni	<0.01	0.02
Cl <sup>-</sup>	2	450
F <sup>-</sup>	0.8	13
(SO <sub>4</sub> ) <sup>2-</sup>	5	300

**Table 3.37: Typical leaching values of bottom ash from hazardous waste incineration plants, measured using DIN-S4 [1, UBA, 2001]**

#### Residues from sewage sludge incinerators:

The chemical structure of sewage sludge ash is influenced considerably by the weather, in particular the amount of rain. In the case of rainy weather, larger amounts of clay and fine sand enter the sewerage system, pass the grit chamber, are precipitated in the preliminary sedimentation basin and reach the sludge incineration with the primary sludge. As a result, the silicate content of the ash is increased considerably, and the contents of other components are diluted in periods of rainy weather.

In addition, the type of catchment and treatments carried out have a great effect on the sludge quality. Areas with a large number of heavy industrial connections may result in higher concentrations of heavy metals (etc) fed to the incinerator, these substances may then accumulate in bottom and fly ashes. Rural areas, with little industry, may give rise to a *cleaner* sludge and hence a lower contamination of incinerator residues.

Another point of major influence is the nature of the treatment (and therefore of the reagents: mineral, polymeric, etc.) that is applied in order to purify the waste water. [74, TWGComments, 2004]

Issues with other waste types:

Clinical wastes:

- burnout needs to be thorough to ensure destruction of infective agents and to disguise recognisable body parts
- the partitioning of radioactive isotopes used in medicines that give rise to wastes may be to the bottom ash or fly ashes - this may result in additional disposal/re-cycling considerations
- hypodermic needles and other sharp materials in the bottom ash may give rise to additional handling risks.

Solid residue quality from fluidised beds:

Because of the difference in the process, waste properties and the combustion temperatures, the quality of ashes is very different to the ashes of grate incinerators. Generally, the lower (but more even) operational temperatures, nature of the fuel and process in fluidised beds mean that:

A greater proportion of volatile heavy metals remain in the bottom ash:

- consequently concentrations of heavy metals in the flue-gas residues are reduced. However, sometimes there are problems with Cr<sup>VI</sup> levels in the soluble part of the bottom ash
- the degree of vitrification of the ash may be reduced
- burnout may be improved.

When recovered fuel is produced for fluidised bed boilers, the ash content is usually 1 – 10 %, and with construction and demolition waste it is normally 1 – 7 %. [33, Finland, 2002]. Household waste burnt in rotating fluidised bed has ash content up to 30 % and with RDF up to 15 %.

Majority of solid residue from fluidised bed incineration is fly ash, which, according to conditions and applied fluidised bed technology, can form up to 90 % of the total ash residue. The bottom ash is also mixed with fluidised bed material (e.g. sand, additives for desulphurisation etc.). When waste or RDF is burnt in a rotating fluidised bed the ratio of bottom ash to fly ash is about 50:50.

When waste originated from construction and demolition is used, a small increase can be found in the heavy metal content of both ashes compared to wood combustion. When the recovered fuel is made of household waste, there is a greater increase in heavy metals. The amount of the increase depends on the type of household waste used. If all the household waste is combusted, the increase is high. If source separation is used, and only combustible packaging material is combusted, the increase of heavy metals is less. Recovered fuels made of industrial wastes can be very variable and therefore result in a wide range of ash qualities.

### 3.5 Energy consumption and production

Energy inputs to the incineration process may include:

- waste (mainly)
- support fuels (usually very few)
- imported electricity (if any).

Production and exports may include:

- heat (as steam or hot water)
- electricity.

Pyrolysis and gasification processes may export some of the energetic value of the incoming waste with the substances they export e.g. syngas, chars, oils, etc. In many cases these products are either directly or subsequently burned as fuels to utilise their energy value, although they may also be used for their chemical value as a raw material, after pretreatment if required.

There are a significant number of incineration plants in Europe that produce and export both electricity and heat.

The combination of exports which is selected depends on a number of factors. Often, whether a local demand exists for steam or heat is decisive for decisions concerning its supply. The relative prices for the supply of the energy produced, and the duration of sales contracts are generally seen as key factors in determining the outcome. This, in turn, has a decisive input on technological decisions regarding the process design. Some of these factors are described in Table 3.38 below:

Factor	Influence
High electricity price paid for supply or reliable demand	<ul style="list-style-type: none"> <li>• encourages investment to produce electricity</li> <li>• boiler claddings may be purchased to allow higher steam pressures and greater electrical outputs</li> <li>• less heat will be available for supply</li> <li>• plant may import electricity to ensure own produced exports can be maximised</li> </ul>
Higher electricity price for imported electricity than that produced	<ul style="list-style-type: none"> <li>• encourages the use of own produced electricity for running the incineration process</li> <li>• heat only plants may decide to divert some energy to supply own electricity demands</li> </ul>
Higher price paid for heat and higher reliability of demand	<ul style="list-style-type: none"> <li>• investment in distribution networks becomes more viable</li> <li>• overall plant efficiency gains possible due to ability to supply more of the recovered energy</li> </ul>
Colder climate	<ul style="list-style-type: none"> <li>• can allow heat supply over more months of the year</li> </ul>
Hotter climate	<ul style="list-style-type: none"> <li>• less reliable heat demand for heating</li> <li>• may increase options to supply heat to drive chillers for air conditioning, to feed seawater thermal desalination plants, etc.</li> </ul>
Base load energy supply contract	<ul style="list-style-type: none"> <li>• increases reliability of sales contract and encourages investment in techniques to utilise available energy (heat and electricity)</li> </ul>
Very low permitted air emissions	<ul style="list-style-type: none"> <li>• additional energy demand of flue-gas treatment equipment</li> </ul>
Not permitted to discharge treated waste water from wet scrubbers	<ul style="list-style-type: none"> <li>• reduction in available heat for export owing to need to supply evaporation energy</li> </ul>
Vitrification of ash required	<ul style="list-style-type: none"> <li>• higher plant energy demand results in increased self-consumption and reduced outputs</li> </ul>
Higher incineration temperature required	<ul style="list-style-type: none"> <li>• possible need for additional fuels to obtain relevant temperature</li> </ul>

**Table 3.38: Some factors and their influence on energy recovery options**

### 3.5.1 Energy efficiency calculation for waste incineration installations

The energy efficiency of a waste incineration installation is often expressed in terms of a percentage. When considering such data it is important to ensure that the calculations that underpin these have been performed in a way that permits comparisons to be made. Failure to do so may result in inappropriate conclusions being drawn.

Some steps that are required to avoid problems with such calculations are:

#### 1. Define the system/calculation boundary

If the incoming waste requires significant pretreatment (e.g. crushing, shredding, drying etc.) this can result in very significant additional energy requirements.

#### 2. Account for all energy inputs

Some installations use additional fuels to maintain combustion temperatures. The energy recovered at the installation will be partly derived from the waste, and partly derived from the additional fuel.

#### 3. Account for re-circulating energy flows

In some cases electricity and/or heat that is recovered from the waste, is then used within the installation. When this is carried out, the net result is a reduction of exported energy and an equivalent reduction of imported energy.

#### 4. Decide whether to simply add energy outputs or use equivalence factors to account for their relative value?

Simple addition of the electrical and heat outputs can create difficulties when considering the relative efficiencies of installations that produce different quantities of these energy flows. The use of equivalence factors can allow consideration of the relative value of these commodities i.e. it can allow consideration of the value of the energy production that the recovered energy displaces. The equivalence factors assigned will be dependent upon the energy mix that the energy recovered at the incineration installation replaces.

Where equivalence factors have been used in this document, a note of the factor used is included (see also Section 3.5.3 regarding equivalence factors).

An example an energy efficiency calculation is given in appendix 10.4. This method was developed by members of a sub-group of the TWG, and was used to provide some of the summary survey data reported in this chapter.

### 3.5.2 Waste net calorific value calculation

Information regarding the typical calorific value ranges exhibited by various waste types, NCV survey and variation data and an example method for the calculation of net calorific value are included in Section 2.4.2.

### 3.5.3 Equivalence factors

[Energysubgroup, 2002 #29]

When comparing different incineration plants, a common unit of energy measure is needed. Energy can be quantified in a number of ways, depending on the energy type of the resource. Fuels are usually quantified either by their heat content (joules) or in fuel equivalence values (usually, oil or hard coal equivalents).

The **joule (J)** is the common unit used in this document to convert the measuring units of different forms of energy into a common unit. To calculate and express energy efficiencies at WI plants it is necessary to take into account the form of the energy consumed and produced.

Taking account of the energy form, requires the comparison of different units of measurement i.e. MWh, MWh<sub>e</sub>(electricity), MWh<sub>th</sub>(thermal energy). The following table gives conversion factors (for externally generated sources) assuming an average of 38 % for electrical conversion efficiency (i.e. 1MWh = 0.38 MWh<sub>e</sub>), and 91 % for external heat generation (i.e. 1MWh = 0.91MWh<sub>th</sub>):

From:	Multiply by:			
To:	GJ	MWh	MWh <sub>e</sub>	MWh <sub>th</sub>
GJ	1	0.2778	0.1056	0.2528
MWh	3.6	1	0.3800	0.9100
MWh <sub>e</sub>	9.4737	2.6316	1	-
MWh <sub>th</sub>	3.9560	1.0989	-	1
Gcal	4.1868	1.163	0.4421	1.0583

**Table 3.39: Energy equivalence conversion factors**  
[29, Energysubgroup, 2002, 64, TWGComments, 2003]

It is important to understand that equivalence values are not exact coefficients or conversion factors. They provide an estimate of the energy that is required to produce the energy externally.

### 3.5.4 Data on the recovery of energy from waste

[1, UBA, 2001]

The generation of electricity is limited by:

- the high-temperature corrosion that may occur in the heat conversion area (boiler, economiser etc.) due to the contents of certain materials, including chlorine, in the waste
- fouling of the boiler - above approx. 600 to 800 °C the ashes are sticky due to the presence of some smelting substances.

The steam parameters (and hence electrical efficiency) of incineration plants are therefore limited. A steam pressure of 60 bar and a temperature of 520 °C can be considered the maximum at present, and only then where special measures are taken to limit corrosion.

For electricity production from MSW typical superheated steam conditions are 40 to 45 bar and 380 to 400 °C. [74, TWGComments, 2004] Lower figures, generally less than 30 bar and 300 °C, are applied where electricity is generated from hazardous wastes owing to the increased corrosion risks (leading to operational difficulties and costs) with acidic flue-gases at higher steam parameters.

Where only heat or steam is supplied, operators tend to use lower boiler pressures and temperatures to avoid the need for the additional investment and maintenance and the more complex operation conditions associated with the higher parameters. In the case where heat supply is prioritised, high pressure and temperature are not justified. Typically for heat supply, the steam will be generated at lower values e.g. around 25 to 30 bar and 250 to 350 °C.

The majority of larger waste incinerators in Europe recover energy from the waste. There are some plants without heat utilisation, these concern generally relate to very specific designs or older/smaller plants. For example:

- hazardous waste incineration plants using flue-gas quenching in order to reduce risks of PCDD/F reformation (e.g. UK and France). In these cases, some heat recovery may still be made from the hot quench water that is produced by the quench scrubber
- relatively small municipal waste incineration plants (particularly in France, but also some in Italy and Belgium).

The following boiler efficiencies are reported to be achieved:

- fluidised bed boilers with exhaust gas temperatures of about 160 °C can achieve boiler efficiencies of about 90 %.
- grate firing furnaces have a boiler efficiency of about 80 %.

[74, TWGComments, 2004]

With such boiler efficiencies (80 – 90 %) and higher than normal steam parameters (note: actual application depends greatly on waste type owing to increased corrosivity of flue-gases with some waste types) the following approximate electrical efficiencies may result:

- steam parameters of 60 bar and 420° about 25 % of the energy converted in the steam generator can be recovered as electrical energy (i.e. overall electrical efficiency of 20 % in the case of grate firing and 22.5 % in the case of FBR)
- if the steam parameters are further increased to 80 bar and 500 °C an electrical efficiency of 30 % can be achieved (i.e. overall electrical efficiency of 27 % in the case of FBR).

[74, TWGComments, 2004]

If there is the possibility to connect the steam cycle of a waste incineration plant to the steam cycle of an adjacent power plant, the overall electrical efficiency can be as high as 35 %. [74, TWGComments, 2004]

#### 3.5.4.1 Electricity recovery data

[1, UBA, 2001]

Although there are significant local variations, typically approx. 400 to 700 kWh of electricity can be generated with one tonne of municipal waste in a municipal waste incineration plant. This is dependent upon the size of the plant, steam parameters and degrees of steam utilisation and mainly on the calorific value of the waste.

The amount of energy available for export usually depends upon the amount produced and the degree of self consumption by the installation - which can itself vary significantly. The FGT system consumption is often significant and varies with the type of system applied (and emission levels required). In some cases, the energy required to run the installation is imported from external supply, with all of that generated by the installation being exported – the local balance usually reflects local pricing for the electricity generated compared to general grid prices.

A survey of eight investigated MSW plants (2001 data) carried out by the TWG energy sub-group gave the following results:

Electricity	Units	Minimum	Average	Maximum
Production	MWh <sub>e</sub> /t waste	0.415 (12.9 %)	0.546 (18 %)	0.644 (22 %)
	GJ <sub>e</sub> /t waste	1.494	1.966	2.319
Export	MWh <sub>e</sub> /t waste	0.279 (8.7 %)	0.396 (13 %)	0.458 (18 %)
	GJ <sub>e</sub> /t waste	1.004	1.426	1.649

- Figures are given as measured (i.e. not factored equivalents)
- Percentage efficiencies are given in parenthesis (also not factored) and take account of energy derived from imported fuels as well as from waste
- Figures for production include all electricity generated
- Figures for export exclude electricity produced by the process but consumed in the process
- NCV average value was 2.9MWh/t

**Table 3.40: Electricity production and export rates per tonne of MSW**  
Source [Energysubgroup, 2002 #29]

Other data supplied for French installations shows the following results:

Electricity	Units	For units >3t/h			New Units
		Minimum	Average	Maximum	Average
Production	MWh <sub>e</sub> /tonne waste	0.148 (4.6 %)	0.368 (11.4 %)	0.572 (17.8 %)	0.528 (16.4 %)
	GJ <sub>e</sub> /tonne waste	0.5328	1.389	1.897	1.900
Export	MWh <sub>e</sub> /tonne waste		0.285 (8.8 %)		0.430
	GJ <sub>e</sub> /tonne waste		1.026		1.548

**Table 3.41: Electricity production and export data per tonne of MSW for MSWI in France**  
[64, TWGComments, 2003]

### 3.5.4.2 Heat recovery data

A survey of fifteen investigated MSW plants (2001 data) carried out by the TWG energy subgroup gave the following results:

Heat	Units	Minimum	Average	Maximum
Production	MWh <sub>th</sub> /t waste	1.376 (45.9 %)	1.992 (65.8 %)	2.511 (74.3 %)
	GJ <sub>th</sub> /t waste	4.953	7.172	9.040
Export	MWh <sub>th</sub> /t waste	0.952 (29.9 %)	1.786 (58.8 %)	2.339 (72.7 %)
	GJ <sub>th</sub> /t waste	3.427	6.600	9.259

- All figures are given as measured (i.e. not factored equivalents)
- Percentage efficiencies are given in parenthesis (also not factored) and take account of energy derived from imported fuels as well as from waste.
- Figures for production include all heat produced by the boiler
- Figures for export exclude heat produced by the process but consumed in the process

**Table 3.42: Heat production and export rates per tonne of MSW**  
[Energysubgroup, 2002 #29]

Other data supplied by France show the following results:

Heat	Units	For units >3t/h		
		Minimum	Average	Maximum
Production	MWh <sub>th</sub> /t waste	0.292 (9 %)	0.978 (30.4 %)	1.595 (49.6 %)
	GJ <sub>th</sub> /t waste	1.051	3.502	5.742
Export	MWh <sub>th</sub> /t waste		0.902 (28 %)	
	GJ <sub>th</sub> /t waste		3.247	

**Table 3.43: Heat production and export rates per tonnes of MSW for MSWI in France**  
[64, TWGComments, 2003]



### 3.5.4.3 Combined heat and power data

[1, UBA, 2001]

In the case of combined electricity/heat generation, approx. 1250 kWh of additional heat per tonne of waste can be used at full load.

If a base load supply situation exists, the gross degree of utilisation can be increased to 75 % to 76 % of the energy input (thermal value).

A survey of 50 investigated MSW plants (2001 data) carried out by the TWG energy sub-group gave the following percentage efficiencies for CHP:

CHP	Average efficiency
<b>Production</b>	59.4 %
<b>Export</b>	49.3 %
Note: To allow addition of heat and electricity to provide a single efficiency measure, a factor of 2.6316 is applied to electrical efficiencies. This factor takes account of the unavoidable losses of electrical energy production and allows processes producing different balances of heat and power to be compared (and hence averaged) with greater meaning.	

**Table 3.44: Average CHP percentage efficiency (calculated as energy equivalents) for 50 MSWI plants**

Source [Energysubgroup, 2002 #29]

Note: A statement about minimum and maximum efficiencies for combined heat and power production (export) is not possible and therefore not included in Table 3.44. This is because the summation of minimum heat and minimum electricity as well as of maximum values leads to misleading results.

Other data provided by France are shown below. The figures show average values:

	Units	For installations >3t/h	New installations
<b>Electricity production</b>	MWh <sub>e</sub> /t waste	0.168	0.382
	GJ <sub>e</sub> /t waste	0.604	1.375
<b>Heat production</b>	MWh <sub>e</sub> /t waste	0.647	0.944
	GJ <sub>e</sub> /t waste	2.329	3.398
<b>Electricity exported</b>	MWh <sub>e</sub> /t waste	0.107	0.300
	GJ <sub>e</sub> /t waste	0.385	1.08
<b>Heat exported</b>	MWh <sub>e</sub> /t waste	0.546	0.578
	GJ <sub>e</sub> /t waste	1.965	2.08

**Table 3.45: Average CHP recovery values per tonne of MSW in MSWI in France**

[64, TWGComments, 2003]

### 3.5.4.4 Boiler conversion efficiency data

A survey of 50 investigated MSW plants (2001 data) carried out by the TWG energy sub-group gave the following data:

	Minimum	Average	Maximum
<b>Boiler efficiency</b>	75.2 %	81.2 %	84.2 %
1. The percentages show the efficiency of transfer of energy from the hot flue-gases to the boiler steam 2. The NCV of the waste is calculated using the method given in Section 2.3.2.1 3. Boiler efficiency may be lower for small units [74, TWGComments, 2004]			

**Table 3.46: Survey data of MSWI boiler efficiencies**

[64, TWGComments, 2003]

### 3.5.5 Data on the consumption of energy by the process

[1, UBA, 2001]

The incineration process itself requires energy for its operation e.g. pumps and fans. The demand varies greatly depending on the construction of the plant [1, UBA, 2001]. In particular the process demand may be increased by:

- mechanical pretreatment systems e.g. shredders and pumping devices or other waste preparation
- incineration air preheating
- reheat of flue-gas (e.g. for gas treatment devices or plume suppression)
- operation of waste water evaporation plant or similar
- flue-gas treatment systems with high pressure drops (e.g. filtration systems) which require higher powered forced draught fans
- decreases in the net heat value of the waste - as this can result in the need to add additional fuels in order to maintain the required minimum combustion temperatures
- sludge treatment e.g. drying.

[64, TWGComments, 2003]

In some cases, these demands can be met partially or entirely through heat exchange with the hot incineration gases.

Older plants with retrofitted flue-gas cleaning systems may consume more electricity compared with modern plants with integrated systems. For industrial plants for hazardous waste incineration, a range of 132 to 476 kWh/t of waste is seen [1, UBA, 2001].

Table 3.47 below shows the specific energy demand of 50 investigated MSW plants (2001 data), as carried out by the TWG energy sub-group. The table shows the electricity demand, the heat demand and the total (as equivalents) demand for entire incineration plants, expressed per tonne of treated waste:

Energy demand type	Units	Minimum	Average	Maximum
<b>Electricity (absolute)</b>	MWh <sub>e</sub> /t waste	0.062	0.142	0.257
	GJ <sub>e</sub> /t waste	0.223	0.511	0.925
<b>Heat (absolute)</b>	MWh <sub>th</sub> /t waste	0.021	0.433	0.935
	GJ <sub>th</sub> /t waste	0.076	1.559	3.366
<b>Total demand (equivalents)</b>	MWh <sub>eq</sub> /t waste	0.155	0.575	1.116
	GJ <sub>eq</sub> /t waste	0.558	2.070	4.018
1 All figures are given as measured (i.e. not factored equivalents)				
2 Percentage efficiencies are given in parenthesis (also not factored) and take account of energy derived from imported fuels as well as from waste.				
3 Figures for production include all heat produced by the boiler				
4 Figures for export exclude heat produced by the process but consumed in the process				

**Table 3.47: Electricity, heat and total energy demand data for 50 surveyed European MSWI per tonne of waste treated**  
[Energysubgroup, 2002 #29]

The energy consumption of the installation also varies according to the calorific value of the waste. This is largely due to increased flue-gas volumes with higher NCV waste – requiring larger FGT capacity. The relationship is shown in the graph below:

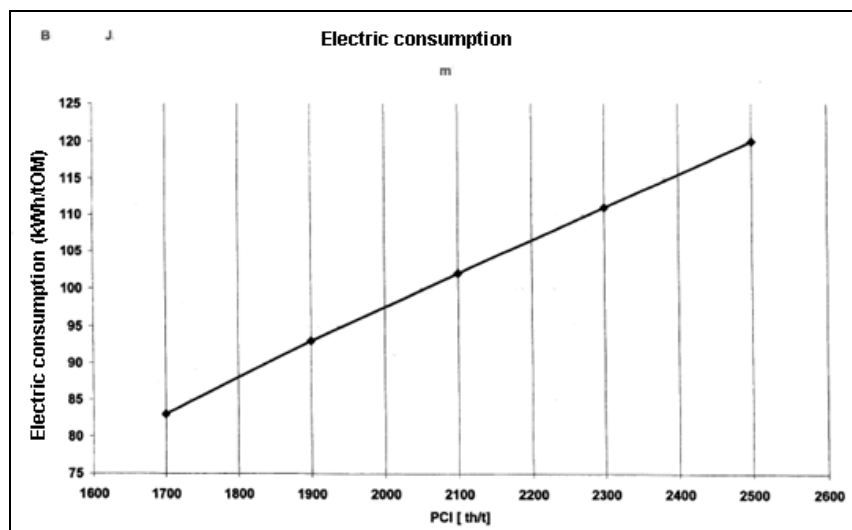

Figure 3.20: Graph showing increase in installation electrical consumption with increasing waste NCV

### 3.5.6 Data comparing energy required by, and output from, the installation

A number of different methodologies may be used to compare installation consumption with overall energy recovery rates. In this example, developed by the energy sub-group of the BREF TWG the energy required to treat the waste is compared to that recovered from the waste. Other indicators are also used that compare the ratio of output to input energy.

The plant efficiency potential ( $Pl_{ef}$ ) provides a figure that compares the energy exported from the process and the energy that the process itself requires for its operation:

$$Pl_{ef} = (O_{exp} - (E_f + E_{imp})) / (E_f + E_{imp} + E_{circ})$$

Where:

$E_f$  = annual energy input to the system by non-waste fuels that add to steam production (GJ/yr)

$E_{imp}$  = annual imported energy (Note: energy from the treated waste ( $E_w$ ) is not included)

$E_{circ}$  = annual energy circulated (i.e. that generated by, but used in, the installation)

$O_{exp}$  = annual exported energy (combined total of heat plus electricity as equivalents)

Note: Because different types of energy (electricity and heat) are added all figures calculated as equivalents at the consumption.

The exported (e.g. sold) energy minus the imported energy is divided by the total energy demand for the waste incineration process, including flue-gas cleaning, generation of heat and electricity. Because the calculation does not take into account the energy content in the waste, it only allows efficiency comparison of incinerators processing similar wastes.

Table 3.48 below shows the results of a survey by the TWG energy sub group:

Process type	Number of plants surveyed	Minimum	Average	Maximum
CHP PI <sub>ef (CHP)</sub>	50	0.6	2.0	7.1
Electricity only PI <sub>ef (electr.)</sub>	8	0.6	1.2	1.6
Heat only PI <sub>ef (heat)</sub>	15	1.0	2.8	7.1
Note: Because the calculation does not take into account the energy content in the waste, it only allows efficiency comparison of incinerators processing similar (CV) wastes.				

**Table 3.48: Ratio of exported and consumed energy for various waste incinerators**  
Source [Energysubgroup, 2002 #29]

Where the result is higher than 1 this shows that the plant is exporting more energy gained from waste than that which is required to operate the waste incineration process.

Where the result is below one this shows that the plant is using more energy to operate the waste incineration installation than it is recovering from the waste. Such a situation may be envisaged at an installation treating very low calorific value wastes.

This calculation does not require knowledge of the energy content of the waste. However, the result will be influenced by the waste energy content, and it can be expected that wastes with a higher energy content can result in greater energy exports, and hence higher values of PI<sub>ef</sub>.

### 3.6 Noise

Table 3.49 below described the sources and levels of noise, generated at waste incineration installations, along with some of the reduction measures used:

Area relevant to noise/ main emitters	Reduction measures	Noise level $L_{WA}$ in dB(A)
Delivery of waste i.e. noise from lorries etc.	Tipping hall closed to all sides	104 - 109
Shredding	Scissors in tipping hall	95 - 99
Waste bunker	Noise insulation of the building with gas concrete, gates with tight design	79 - 81
Boiler building	Enclosure with multi-shell construction or gas concrete, ventilation channels with connecting link silencers, tight gates	78 - 91
Machine building	Use of low-noise valves, noise-insulated tubes, noise insulation of the building as described above	82 - 85
Flue-gas cleaning: - ESP - Scrubbing - Suction draught - Chimney - Total flue-gas cleaning system	Noise insulation, enclosure of the facility e.g. with sheets with trapezoidal corrugations, use of blimps for the suction draught and silencer for the chimney	82 - 85 82 - 85 82 - 84 84 - 85 89 - 95
Disposal of residues - Bottom ash discharge - Loading - Transportation from the plant - Total waste management residues	Enclosure, loading in the bunker	71 - 72 73 - 78 (day) 92 - 96 (day) 92 - 96 (day) 71 - 72 (night)
Air cooler	Silencers on the suction and pressure sides (see also BREF on cooling systems for further information)	90 - 97
Energy transformation facility	Low-noise design, within specially constructed noise proofed building	71 - 80
<b>Total level <math>L_{WA}</math> of the plant</b>		
<b>Day</b>		<b>105 - 110</b>
<b>Night</b>		<b>93 - 99</b>
Note: Day/night indicates that the operation is usually carried out during the day or night.		

**Table 3.49: Sources of noise at waste incineration plants**  
[1, UBA, 2001]

With the noise reduction measures described above, the noise emission limits, given for a specific project based on the local conditions, can be safely met, by day and by night.

Noise is also generated during the construction phase. This may result in considerable noise exposure in neighbouring residential areas, depending mainly on the location. Three main construction stages are all equally relevant as noise sources:

- digging the excavation
- laying the foundations (including pile-driving) and
- erecting the outer shell of the building.

Appropriate measures, such as restrictions on operating hours, particularly during the night, use of low-noise construction machinery and temporary structural sound insulation measures, may be taken. In some MSs, specific legislation also exists for this.

[1, UBA, 2001], [2, infomil, 2002], [64, TWGComments, 2003]

## 3.7 Other operating resources

This section describes some of the substances consumed by the incineration process and gives available data. Table 3.51 at the end of this section, provides data regarding the quantities of various substances consumed by hazardous waste incinerators.

### 3.7.1 Water

The main consumption of water in waste incineration plants is for flue-gas cleaning. Dry systems consume the least water and wet systems generally the most. Semi-wet systems fall in between.

Typical effluent rates at a MSWI are around 250kg/t of waste treated (wet scrubbing, other FGT technologies provide different figures).

It is possible for wet systems to reduce consumption greatly by re-circulating treated effluent as a feed for scrubbing water. This can only be performed to a certain degree as salt can build up in the re-circulated water.

The use of cooled condensing scrubbers provides a further means by which water can be removed from the flue-gas stream, which then, after treatment, can be re-circulated to the scrubbers. Salt build up remains an issue.

Processes without energy recovery boilers may have very much higher water consumption. This is because the required flue-gas cooling is carried out using water injection. Consumption rates of up to 3.5 tonnes water/tonne waste are seen in such cases (Belgium 2002). Installations with a rapid quench system (such as those operated in the UK for HWI) may use up to 20 tonnes of water per tonne of waste incinerated.

The water consumption for FGT in HWI is about 1 - 6 m<sup>3</sup> per tonne of waste; and for sewage sludge is about 15.5 m<sup>3</sup> per tonne of waste.

[74, TWGComments, 2004]

### 3.7.2 Other operating resources

[1, UBA, 2001]

The following consumption (and residual products) rates can be calculated for their **stoichiometric reaction** during flue-gas cleaning:

Pollutant		Ca(OH) <sub>2</sub>	Residual products	
	kg	kg		kg
HCl	1	1.014	CaCl <sub>2</sub>	1.521
HF	1	1.850	CaF <sub>2</sub>	1.950
SO <sub>2</sub>	1	1.156	CaSO <sub>4</sub>	2.125
Pollutant		NaOH	Residual product	
HCl	1	1.097	NaCl	1.600
HF	1	2.000	NaF	2.100
SO <sub>2</sub>	1	1.249	Na <sub>2</sub> SO <sub>4</sub>	2.217
Pollutant		Sodium Bicarbonate	Residual product	
HCl	1	2.301	NaCl	1.603
HF	1	4.200	NaF	2.100
SO <sub>2</sub>	1	2.625	Na <sub>2</sub> SO <sub>4</sub>	2.219
Pollutant		Ammonia	Residual product	
NO	1	0.370	Not applicable	
NO <sub>2</sub>	1	0.739		
Pollutant		Urea	Residual product	
NO	1	0.652	Not applicable	
NO <sub>2</sub>	1	1.304		

Note:

1. to establish accurate reagent ratios it is necessary to take into account the initial emission level and the targeted emission level.
2. Reactants may be supplied at varying concentrations and this may therefore alter overall mixed reagent consumption rates.

**Table 3.50: Stoichiometric calculation of amounts of lime used for absorption during flue-gas cleaning (reactants expressed at 100 % concentration and purity)**

[1, UBA, 2001] [74, TWGComments, 2004]

#### 3.7.2.1 Neutralisers

[1, UBA, 2001]

To neutralise the acids contained in the flue-gas, either NaOH, hydrated lime milk of lime or sodium bicarbonate is used. Their consumption depends on the specific structure of the waste (and hence the raw gas content) as well as the technical equipment used (contact, mixing etc).

For hydrated lime, 6 kg/t to 22 kg/t of waste are consumed depending on flue-gas cleaning type and other factors. For NaOH, 7.5 - 33 kg/t of waste

[74, TWGComments, 2004]

#### 3.7.2.2 NO<sub>x</sub> removal agents

Typical reagents for the removal of NO<sub>x</sub> from the flue-gas are ammonia, ammonia water (25 % NH<sub>3</sub>) and urea solution. The latter, is, in particular, depending on the producer, often supplemented by additional ingredients.

If upstream NO<sub>x</sub> concentrations are known this helps for a well controlled process. [74, TWGComments, 2004]

The use of these materials must be performed in a targeted manner and well controlled to prevent excessive formation of ammonia or the direct slippage of the excess ammonia.

For ammonia water, a consumption rate of 2.5 kg/t of waste is quoted. Research has shown a range of 0.5 to 5 kg/t of waste.

### 3.7.2.3 Fuel oil and natural gas

Light fuel oil (diesel), heavy fuel oil (about 0.03 - 0.06 m<sup>3</sup> per tonne of waste) and natural gas (in Austrian plants between 4.5 and 20 m<sup>3</sup> per tonne of waste) are used for process heating and support burners. [74, TWGComments, 2004]

Waste solvents (typically with a thermal value of >25 MJ/kg) are also used as support fuels in some plants.

High calorific wastes (e.g. oils and solvents, typically those with a thermal value of >15 MJ/kg) are routinely used as support fuel in rotary kiln hazardous waste incineration plants.

If the flue-gas is reheated for individual process steps (e.g. SCR) this is mainly done with natural gas.

### 3.7.2.4 Merchant hazardous waste incinerator plant survey data

[EURITS, 2002 #41]

An overview is given below of the minimum and the maximum amount of additives in kilograms per tonne of incinerated waste for surveyed merchant hazardous waste installations:

Additives	kg/t waste		
	Minimum	Maximum	Average
CaO + Ca(OH) <sub>2</sub> (100 %), as CaO	1.33	97	28.6
NaOH (50 %)	0.40	41.67	15.5
CaCO <sub>3</sub>	11.9	23.76	17.4
HCl (33 %)	0.14	10	1.5
TMT-15 or other sulphide treatment	0.0085	0.98	0.23
Na <sub>2</sub> S	0.008	0.83	0.44
Na <sub>2</sub> S <sub>2</sub> O <sub>3</sub>	0.08	4.2	1.7
FeCl <sub>3</sub>	0.049	0.50	0.27
FeClSO <sub>4</sub>	0.15	0.96	0.55
Fe Al chloride	1.75	1.75	1.75
PE	0.01	1.30	0.3
Activated carbon	0.3	19.31	3.7
Urea (45 %)	3.1	3.1	3.1
NH <sub>4</sub> OH	0.50	3.33	2.1
CaCl <sub>2</sub>	2.36	2.36	2.36
Note: This table gives only some reference values and may not be representative for a specific installation or technique.			

**Table 3.51: Amount of additives used by merchant hazardous waste incineration processes**  
Source [EURITS, 2002 #41]



## 4 TECHNIQUES TO CONSIDER IN THE DETERMINATION OF BAT

This chapter sets out techniques considered generally to have potential for achieving a high level of environmental protection in the industries within the scope of the document. Management systems, process-integrated techniques and end-of-pipe measures are included. Prevention, control, design, management and re-cycling procedures are considered as well as the re-use of materials and energy

Techniques may be presented singly or as combinations to achieve the objectives of IPPC. Annex IV to the Directive lists a number of general considerations to be taken into account when determining BAT and techniques within this chapter will address one or more of these considerations. As far as possible a standard structure is used to outline each technique, to enable comparison of techniques and an objective assessment against the definition of BAT given in the Directive.

Because it is not possible to be exhaustive and because of the dynamic nature of industry, and the momentary nature of this document, it is possible that there may be additional techniques not described but which may also be considered BAT. These are likely to be techniques that meet or exceed the BAT criteria established here and in Chapter 5, applied locally as thus provide particular advantages in the situation in which they are used.

[64, TWGComments, 2003]

### Organisation of Chapter 4:

This chapter groups the techniques in approximately the order in which they would appear in the majority of waste incineration installations. Thus it highlights the specific techniques that can be applied at **each stage** of the incineration process, and that can lead to improved environmental performance or other benefits that are of relevance to determining BAT.

Table 4.1 gives the title of the sections and indicates the grouping to which the techniques have been divided for BREF purposes.

Chapter 4 section number (and hyperlink to section)	Title of section
4.1	General practices applied before thermal treatment
4.2	Thermal processing
4.3	Energy recovery
4.4	Flue-gas treatment
4.5	Process water treatment and control
4.6	Treatment techniques for solid residues
4.7	Noise
4.8	Environmental management tools
4.9	Good practice for public awareness and communication

**Table 4.1: Organisation chart for the information in Chapter 4**

### Description:

Each technique described includes relevant information, made available by the TWG, on the consumption and emission levels considered achievable by using the technique, some idea of the costs and the cross-media issues associated with the technique and information on the extent to which the technique is applicable to the range of installations requiring IPPC permits, for example new, existing, large or small installations, and to various waste types.

As far as possible, a standard structure is used to outline each technique, as shown in the following table, to enable comparisons of techniques and an objective assessment against the definition of BAT given in the Directive. BAT determination itself is not covered here but is covered in Chapter 5. Table 4.2 below shows the structure of the information that is included where possible, for each technique in this chapter:

<b>Type of information considered</b>	<b>Type of information included</b>
<b>Description</b>	Technical description of the technique
<b>Achieved environmental benefits</b>	Main environmental impact(s) to be addressed by the technique (process or abatement), including emission values achieved and efficiency performance (see also IPPC Directive annexe IV). Environmental benefits of the technique in comparison with others
<b>Cross-media effects</b>	Any side-effects and disadvantages caused by implementation of the technique. Details on the environmental problems of the technique in comparison with others
<b>Operational data</b>	Performance data on emissions/wastes and consumption (raw materials, additives, water and energy). Any other useful information on how to operate, maintain and control the technique, including safety aspects, operability constraints of the technique, output quality, etc.
<b>Applicability</b>	Consideration of the factors involved in applying and retrofitting the technique (e.g. space availability, process specific)
<b>Economics</b>	Information on costs (investment and operation) and any possible savings (e.g. reduced raw material consumption, waste charges) also as related to the capacity of the technique
<b>Driving force for implementation</b>	Reasons for implementation of the technique (e.g. other legislation, improvement in production quality)
<b>Example plants</b>	Reference to a plant where the technique is reported to be used
<b>Reference literature</b>	Literature for more detailed information on the technique

**Table 4.2: Information breakdown for each technique described in this Chapter 4**

When possible, this chapter provides information on actual activities that are being, or can be implemented by this sector, including actual associated costs. Where possible, the information provided also gives the context in which the technique can be used effectively.

## 4.1 General practices applied before the thermal treatment stage

### 4.1.1 Suitability of process design for the waste(s) received

One of the most important decisions to be made by the waste incinerator operator relates to the selection of a combustion (or thermal treatment) stage that is technically suited to the material that will be fed to the process. Once that design has been selected, the operational objective then becomes one of managing the incoming waste so that its properties remain within the range for which the process is designed (see techniques described in 4.1.3).

In general, existing technologies have been developed in order to meet the specific waste treatment requirements of particular waste streams. The application of a technology developed for a different waste, of possibly unsuitable characteristics, can result in poor or unreliable performance. Some installations are designed as “mass burn” (i.e. to treat wastes of varying composition), others only to receive selected waste streams with narrow specifications. The design required depends on the wastes that will be received for treatment in the incinerator. Significant operational, safety and environmental consequences may result from attempting to treat the wrong waste in the wrong design of installation.

In addition to the target performance (e.g. waste destruction, energy outputs, emission levels), the choice of thermal treatment technique generally needs to take account of the following technical criteria:

- waste chemical composition and variation
- waste physical composition, e.g. particle size and variation
- waste thermal characteristics, e.g. calorific value, moisture levels
- throughput and process availability required
- required bottom ash, and other residue(s) quality and composition
- possibilities for use of products of partial oxidation, such as syngas or coke
- emission level targets and selected abatement system
- type of energy recovery (e.g. heat, electrical power, CHP).

In addition to these technical criteria, the following may also influence the final design choice:

- degree of technical risk
- operational experience and available skill
- budget.

Installations that are designed to treat a narrow range of specific wastes (or highly pretreated and hence more homogeneous waste) operate within a narrower range of performance limits, than those that receive wastes with greater variability. More homogeneous waste can allow improved process stability, with more even and predictable flue-gas composition. Where waste quality can be well controlled, FGT system capacity may be narrowed to some degree without increasing the risk of raw gas concentrations exceeding FGT capacity.

In practice, many waste incinerators may have only limited control over the precise content of the wastes they receive. Operators receiving such wastes thus need to design their processes to be sufficiently flexible to cope with the range of waste inputs that could be fed to the process. [64, TWGComments, 2003]

## 4.1.2 General housekeeping measures

General tidiness and cleanliness contribute to an enhanced working environment and can allow potential operational problems to be identified in advance.

The main elements of good housekeeping are:

- the use of systems to identify and locate/store wastes received according to their risks
- the prevention of dust emissions from operating equipment
- effective waste water management, and
- effective preventive maintenance.

[64, TWGComments, 2003]

## 4.1.3 Quality control of incoming wastes

### 4.1.3.1 Establishing installation input limitations and identifying key risks

#### Description

Every installation has limitations on the characteristics of the wastes that can be fed to the incinerator itself. From knowledge of the incineration process input limitations, it is possible to derive a waste input specification that highlights the maximum and desirable system input rates. It is then possible to identify the key risks, and procedural controls required to prevent or reduce operation outside these limitations.

Factors that set such boundaries include:

- design of waste feed mechanism and the physical suitability of waste received.
- waste flowrate and heat throughput rating of the furnace
- emission limit values required to be reached (i.e. % pollutant reduction required)
- flue-gas cleaning technology capacity for individual pollutant removal (e.g. limit on flue-gas flowrate, pollutant loading, etc.).

Examples of key risks identified can be:

- high mercury input, leading to high raw flue-gas concentrations
- high iodine or bromine input, leading to high raw flue-gas concentrations
- high variability in moisture content or CV, leading to combustion irregularities
- high chlorine loading exceeding FGT capacity
- high sulphur loading exceeding FGT capacity
- rapid change in flue-gas chemistry that effects FGT function
- physically large items blocking feed systems - leading to an interruption of regular operation
- excessive slagging/fouling of boiler components when certain types of waste are being fed e.g. high Zn concentration sources (contaminated wood waste) have been reported to cause abnormal slagging in the first boiler pass.

Once the theoretical and actual (i.e. those occurring at operational plants) risks have been established the operator can then develop a targeted control strategy to reduce these risks e.g. if operator experience shows that the installation may experience exceedences of HCl emission values then the operator may decide to attempt to control sources and peak concentrations of Cl in the waste as fed to the combustion stage and/or design and operational features of the acid gas FGT applied.

#### Achieved environmental benefits

The use of this technique helps ensure smooth and stable operation of the incinerator and reduces requirement for reactive and emergency process intervention.

**Cross-media effects**

The implementation of process input limitation procedures results in the removal of wastes which fall outside the established specification. Those wastes are then diverted from the incineration process to other waste treatment options. The type and magnitude of cross-media effects that result are therefore dependent upon the type and performance of the alternative treatment option.

**Operational data**

See description above.

**Applicability**

Applicable to all waste incineration plants, particularly those that receive wastes from diverse sources and of a wide or difficult to control specification (e.g. merchant hazardous waste plants).

Existing installations will have the advantage of experience and knowledge from previous situations encountered during the operational lifetime of the installation. New plants may be able to learn from the operational experience of similar existing plants and then adapt and develop their own procedures according to their specific operational experiences.

Installations with extensive storage and pretreatment facilities may be able to accept wastes that are initially outside the normal combustor specification and then treat the waste to meet the combustor requirements.

While merchant HWIs are often built to be able to receive any kind of hazardous waste, this is not the case for many other installations including MSWIs. However, some types of waste which are similar in nature to MSW are treated in some MSWIs e.g. commercial waste, some clinical wastes and sewage sludges. The installation may require some adaptation to be suitably equipped to treat wastes that differ in nature from the main type received. This would generally include the provision of adequate reception, storage and handling systems. If the waste is significantly different then more extensive adaptations may also be required e.g. to the furnace type, FGT, waste water treatment system, specific safety measures and laboratory/testing equipment. [64, TWGComments, 2003]

**Economics**

Costs are not precisely quantifiable.

Excluding some waste sources/types may reduce income. In addition, specific investment may be required to introduce techniques to identify and manage such wastes, e.g. analysis, pretreatment.

**Driving force for implementation**

A good knowledge of process limitations is required in order to assess and select procedures to control input and hence the overall process performance.

**Example plants**

Widely employed practice at hazardous waste incineration plants in particular.

The technique is also applied at many European MSWIs in order to identify and possibly exclude undesired waste types.

**Reference literature**

[55, EIPPCBsitevisits, 2002] [64, TWGComments, 2003]

### 4.1.3.2 Communication with waste suppliers to improve incoming waste quality control

#### **Description**

Wastes are commonly received from a wide variety of sources over which the operator may have only limited control. Where the operator has identified specific wastes, substances or properties of wastes, or individual sources that can or do cause operational problems, the communication of the operator's concerns to those persons producing and supplying the waste can help in the overall chain of waste management. An example is the separate collection of Hg containing wastes such as batteries, or dental amalgam so that the Hg content of the MSW stream is reduced.

The type of techniques used and the degree to which they are employed depends upon the degree of risk and the frequency and nature of any operational difficulties encountered. In general, the greater the variability of the waste types, compositions and sources, the more effort is required in waste input control.

#### **Achieved environmental benefits**

Avoiding the receipt of unsuitable wastes or controlling the delivery of wastes that are difficult to treat or that require special care can reduce operational difficulties and hence avoid additional releases.

#### **Cross-media effects**

Some wastes may need to be diverted from the incinerator to other waste treatment options.

#### **Operational data**

##### **Applicability**

This technique can be applied to all waste incineration plants, but is of most use at those receiving wastes from diverse sources and of a wide, or difficult to control, specification (e.g. merchant hazardous waste plants).

Processes that are designed to receive a narrow range of well-defined wastes may need to take particular care to ensure key substances are controlled.

Existing plants will have the advantage of learning from the real situations already encountered.

##### **Economics**

Savings may arise from avoiding operational difficulties.

##### **Driving force for implementation**

Procedures to control input can reduce the risks of operational upsets and associated releases.

##### **Example plants**

Widely employed practice at hazardous waste incineration plants, in particular.

SELCHP (South East London, UK) MSWI identified sources of gypsum (Calcium Sulphate) which were disturbing the operation.

In Caen (France) a successful information campaign to reduce the Hg content in MSW was carried out.

##### **Reference literature**

[64, TWGComments, 2003]

### 4.1.3.3 Controlling waste feed quality on the incinerator site

#### Description

To help control the waste feed quality, and hence stabilise the combustion process within design parameters, a set of quality requirements can be derived for the waste fed to the combustor. The waste quality requirements can be derived from an understanding of the process operational limitations, such as :

- thermal throughput capacity of the incinerator
- physical requirements of the feed (particle size)
- controls used for the incineration process (e.g. using NCV, steam production, O<sub>2</sub> content etc.)
- capacity of flue-gas treatment system and the derived maximum raw gas input concentrations/rates
- the emission limit values that need to be met
- bottom ash quality requirements.

Wastes can be stored, mixed or blended (this is restricted by some national legislation) to ensure that the final waste that is fed to the combustor falls within the derived set of quality requirements.

The key substances/properties that will usually require particular procedures to be put in place for their management relate to variations in the concentration and distribution in the waste of the following:

- mercury, alkali metals and heavy-metals
- iodine and bromine
- chlorine and sulphur
- variations in heat values/moisture content
- critical organic pollutants e.g. PCBs
- physical consistency of waste e.g. sewage sludge
- mixability of different kind of waste.

The results of CEN/TC 292 and CEN/TC 343 can be relevant for carrying out the sampling of these substances in the waste.

#### Achieved environmental benefits

Reduced emissions to in the flue-gas through:

- smooth process operation
- effective combustion
- improved energy recovery
- more even raw gas concentrations and hence improved operation of flue-gas cleaning plant.
- reduced fouling in boiler by reducing dust release.

#### Cross-media effects

The preparation and storage of wastes can give rise to fugitive emissions that themselves require management.

#### Operational data

No information.

#### Applicability

All installations need to derive their own set of key process input limitations and then adopt suitable receipt restrictions and possible pretreatment to ensure that these limitations are not exceeded.

A requirement to do so will be especially necessary where highly variable waste compositions are encountered (e.g. merchant HWIs), and at smaller capacity plants as these have less operational *buffering* capacity than larger plants.

[64, TWGComments, 2003] This technique finds its main application and benefits at hazardous waste incinerators, although in some countries (e.g. Austria) it is performed at every waste incineration plant.

### **Economics**

Information not supplied.

### **Driving force for implementation**

To help ensure that the feedstock material is suited to the processes used, and hence to allow emissions and consumptions to be controlled within required parameters.

### **Example plants**

Applied particularly at hazardous waste incineration plants in Europe.

### **Reference literature**

[25, Kommunikemi, 2002] [64, TWGComments, 2003]

#### **4.1.3.4 Checking, sampling and testing incoming wastes**

##### **Description**

This technique involves the use of a suitable regime for the assessment of incoming waste. The assessments carried out are selected to ensure:

- that the wastes received are within the range suitable for the installation
- whether the wastes need special handling/storage/treatment/removal for off-site transfer
- whether the wastes are as described by the supplier (for contractual, operational or legal reasons).

The techniques adopted vary from simple visual assessment to full chemical analysis. The extent of the procedures adopted will depend upon:

- nature and composition of waste
- heterogeneity of the waste
- known difficulties with wastes (of a certain type or from a certain source)
- specific sensitivities of the installation concerned (e.g. certain substances known to cause operational difficulties)
- whether the waste is of a known or unknown origin
- existence or absence of a quality controlled specification for the waste
- whether the waste has been dealt with before and experiences with it.

Example procedures are provided under Operational data below.

##### **Achieved environmental benefits**

Advanced identification of unsuitable wastes, substances or properties can reduce operational difficulties and hence to avoid additional releases.

##### **Cross-media effects**

No significant negative cross-media effects.



## Operational data

Waste type	Example techniques applied	Comments
<b>Mixed municipal wastes</b>	<ul style="list-style-type: none"> <li>visual inspection in bunker</li> <li>spot checking of individual deliveries by separate off loading</li> <li>weighing the waste as delivered</li> <li>radioactive detection</li> </ul>	Industrial and commercial loads may have elevated risks and require greater attention
<b>Pretreated municipal wastes and RDF</b>	<ul style="list-style-type: none"> <li>visual inspection</li> <li>periodic sampling and analysis for key properties/substances</li> </ul>	
<b>Hazardous wastes</b>	<ul style="list-style-type: none"> <li>visual inspection</li> <li>control and comparison of data in the declaration list in comparison with delivered waste</li> <li>sampling/analysis of all bulk tankers</li> <li>random checking of drummed loads</li> <li>unpacking and checking of packaged loads</li> <li>assessment of combustion parameters</li> <li>blending tests on liquid wastes prior to storage</li> <li>control of flashpoint for wastes in the bunker</li> <li>screening of waste input for elemental composition e.g. by EDXRF</li> </ul>	Extensive and effective procedures are particularly important for this sector. Plants receiving mono-streams may be able to adopt more simplified procedures
<b>Sewage sludges</b>	<ul style="list-style-type: none"> <li>periodic sampling and analysis for key properties and substances</li> <li>checking for hard materials e.g. stones/metal/wood/plastics prior to pumping transportation, dewatering and drying stages</li> <li>process control to adapt to sludge variation</li> </ul>	The suitability of the techniques is dependent on the kind of sewage sludge e.g. raw sludge, digested sludge, oxidised sludge etc.
<b>Clinical wastes</b>	<ul style="list-style-type: none"> <li>control and comparison of data in the declaration list in comparison with delivered waste</li> <li>screening for radioactivity</li> </ul>	Infection risk makes sampling inadvisable. Control is required by waste producer
<b>Animal by-products</b>	<ul style="list-style-type: none"> <li>control and comparison of data in the declaration list in comparison with delivered waste</li> <li>sampling/testing of low risk material for fat, moisture content</li> </ul>	Sampling not advisable for high risk material for safety reasons

**Table 4.3: Some checking and sampling techniques applied to various waste types** [1, UBA, 2001, 2, infomil, 2002, 41, EURITS, 2002], [64, TWGComments, 2003]

### Applicability

The most extensive sampling and analysis regimes are appropriate where waste compositions and sources are most variable (e.g. merchant hazardous waste plants) or where there are known difficulties e.g. history of problems with a particular waste type or source.

### Economics

The cost of applying these techniques increases rapidly with the extent and complexity of the procedures adopted.

The costs for the sampling, analysis, storage and additional processing time required, can represent a significant proportion of operational costs at hazardous waste plants in particular, where the most extensive sampling and analysis regimes are applied.

### **Driving force for implementation**

To enable better process control and for plant protection.

### **Example plants**

Widely used throughout Europe.

### **Reference literature**

[40, EURITS, 2003], and discussions during site visits. [64, TWGComments, 2003]

#### **4.1.3.5 Detectors for radioactive materials**

##### **Description**

Although radioactive materials are not specifically regulated by IPPC, the inclusion of radioactive sources or substances in waste, can lead to operational and safety problems. Very low “background” levels of radioactivity are present throughout the natural environment and are also be found in wastes – such levels do not require specific measures for their detection and control. However, some wastes are at risk of containing higher levels, particularly those arising from activities that use radioactive materials. Some hospital and industrial wastes may therefore routinely or occasionally contain specific radioactive sources or contamination, although the inclusion of such wastes with municipal waste, and the difficulties of controlling mixed waste collections, can lead to radioactivity in other wastes.

Radioactive materials can often be detected using specific detectors situated at, for example, the entrance to the plant. Tests of waste loads that may have a higher risk of contamination can also be carried out. Such tests are specifically carried out where loads are accepted on the basis of a maximum level of contamination. Such maximum levels are derived from knowledge of the fate of the isotopes treated, and of the particular process receiving them, and on consideration of the limits set on the contamination levels allowed in releases to land, air and water.

Plastic scintillation detectors are one type of detector used; these measure photons from gamma emitting radionuclides and to a lesser extent from beta emitters. Radionuclides are regularly detected in clinical waste, laboratory waste and technically enhanced natural occurring radioactive material. Also important are the controls put in place to prevent the mixing of radioactive waste with regular waste (sometimes done so as to avoid the high treatment cost associated with radioactive waste).

##### **Achieved environmental benefits**

Prevention of plant contamination and release of radioactive substances. Contamination of the installation can result in lengthy and costly shutdowns for decontamination.

##### **Cross-media effects**

The main concern is how to manage the waste that is identified as radioactive - as neither its transport nor treatment may be permitted. Developing plans and procedures advance of such situations for managing any radio-active wastes identified is advantageous.

##### **Operational data**

Some plants report good experiences of using gate controls for radioactive material, after they recognised that the MSW they receive may occasionally contain radioactive materials. [64, TWGComments, 2003]

##### **Applicability**

Applicable to incineration plants where heterogeneous wastes are received from a wide variety of suppliers. Applied less when the sources and variability of the waste are well known and controlled, or where the risk of receiving radioactive materials is judged to be low.

##### **Economics**

Investment cost for installing detectors is approx. EUR 25000 – 50000.

**Driving force for implementation**

Reductions in the tolerable threshold for low level radioactive contamination encourage the use of the technique. These thresholds may vary from one MS to another according to legislative requirements. [64, TWGComments, 2003]

In some Member States, e.g. France, the regulation on MSWI enforces the implementation of detector for radioactive materials (with a few exceptions).

**Example plants**

Applied at hazardous waste and some municipal waste installations.

**Reference literature**

[40, EURITS, 2003], and discussions during site visits. [64, TWGComments, 2003]

**4.1.4 Waste storage**

The basic principles of storage are outlined in the horizontal draft BREF on storage are applicable to the storage of wastes and should be referred to for general guidance on techniques. However, because wastes often have a less well defined or even unknown composition, it is often the case that additional techniques are employed that further improve the security of the storage in order to deal with these *unknown* risks. This section of the BREF therefore concentrates on the specific techniques that are relevant to wastes, rather than the more general aspects of storage.

**4.1.4.1 Sealed surfaces, controlled drainage and weatherproofing****Description**

The storage of wastes in areas that have sealed and resistant surfaces and controlled drainage prevents the release of substances either directly from the waste or by leaching from the waste.

The techniques employed vary according to the type of waste, its composition and the vulnerability or risk associated with the release of substances from the waste. In general, the following storage techniques are appropriate:

Waste type	Storage techniques
<b>General issues applicable to all wastes</b>	<ul style="list-style-type: none"> <li>• Odorous materials stored inside with controlled air systems using the discharged air as combustion air (see 4.1.4.4)</li> <li>• designated areas for loading/offloading with controlled drainage</li> <li>• clearly marked (e.g. colour coded) areas for drainage from potential areas of contamination (storage/loading/transportation)</li> <li>• limitation of storage times according to waste type and risks</li> <li>• adequate storage capacity</li> <li>• baling or containment of some wastes for temporary storage is possible depending on the waste and location specific risk factors</li> <li>• fire protection measures, e.g. fire resisting wall between the bunker and the furnace hall.</li> </ul>
<b>Solid municipal and non hazardous industrial wastes</b>	<ul style="list-style-type: none"> <li>• sealed floor bunkers or sealed level storage areas</li> <li>• covered and walled buildings</li> <li>• some bulk items with low pollution potential can be stored without special measures</li> </ul>
<b>Solid pretreated MSW and RDF</b>	<ul style="list-style-type: none"> <li>• enclosed hoppers</li> <li>• sealed floor bunkers or level storage areas</li> <li>• covered and walled buildings</li> <li>• wrapped or containerised loads may be suitable for external storage without special measures, depending on the nature of the waste</li> </ul>
<b>Bulk liquid wastes and sludges</b>	<ul style="list-style-type: none"> <li>• attack resistant bunded bulk tanks</li> <li>• flanges and valves within bunded areas</li> <li>• ducting of tank spaces to the incinerator for volatile substances</li> <li>• explosion control devices in ducts, etc.</li> </ul>
<b>Drummed liquid wastes and sludges</b>	<ul style="list-style-type: none"> <li>• storage under covered areas</li> <li>• bunded and resistant surfaces</li> </ul>
<b>Hazardous waste</b>	<ul style="list-style-type: none"> <li>• segregated storage according to risk assessment</li> <li>• special attention to the length of storage times</li> <li>• automatic handling and loading devices</li> <li>• cleaning facilities for surfaces and containers</li> </ul>
<b>Clinical/Biohazard wastes</b>	<ul style="list-style-type: none"> <li>• segregated storage</li> <li>• refrigerated or freezer storage for biohazard wastes</li> <li>• special attention to the reduction of storage times</li> <li>• automatic handling and loading devices</li> <li>• container disinfection facilities</li> <li>• freezer storage, if the storage period exceeds certain time periods e.g. 48 hours</li> </ul>

**Table 4.4: Some examples of applied storage techniques for various waste types [64, TWGComments, 2003]**

### Achieved environmental benefits

Proper storing of wastes has many benefits:

- reduction of risks of releases through secure containment
- prevention of rainwater penetration of the stored waste (and thus reduction in LCV and difficulty in combustion)
- prevents wind scatter
- reduces leachate production (and thus subsequent management requirements)
- reduces mobilisation of pollutants
- reduces deterioration of containers (corrosion and sunlight)
- reduces temperature related expansion and contraction of sealed containers
- reduces odour releases and allows their management
- allows management of fugitive releases.

**Cross-media effects**

Additional buildings and infrastructure required.

**Operational data**

No specific information supplied.

**Applicability**

The general principle of assessing the waste types received and providing appropriate (i.e. that reduces the spread of contamination and the risks of storage and handling releases) secure storage for them,, is applicable to all installations.

The degree and precise methods adopted depends upon the wastes received and are outlined above. In general, liquid wastes and hazardous wastes require the most attention.

**Economics**

No specific data supplied.

**Driving force for implementation**

The application of safe storage is a fundamental technique for effective waste management and for the prevention of releases.

**Example plants**

Widely applied throughout Europe. Examples seen in B, D, DK, F, FIN.

**Reference literature**

Discussions during site visits. [64, TWGComments, 2003]

**4.1.4.2 Management of storage times**

Reducing storage times can be useful for:

- preventing the deterioration of containers (weathering, ageing, corrosion)
- preventing the putrefaction of organic waste (which may otherwise lead to odour releases, processing and handling difficulties, fire and explosion risks)
- reducing the risk of labels becoming detached.

Storage times can be reduced by:

- preventing the volumes of wastes stored from becoming too large
- controlling and managing deliveries (where possible) by communication with waste suppliers, etc.

In general, MSW is stored in enclosed buildings for a period of 4 to 10 days, with the storage periods being strongly influenced by collection/delivery patterns. Because of the desire to run installations on a continuous basis, the storage capacity and hence maximum storage times will often be determined by the maximum amount of time when no waste is likely to be delivered to the plant. Holiday periods in particular can result in several days when no waste is delivered. [64, TWGComments, 2003]

A limited time for the maturation of municipal waste in the bunker may have a positive effect on the homogeneity of the waste. Feeding fresh waste immediately after it has been delivered may induce fluctuations in the process. [74, TWGComments, 2004]

Where various sources and types of waste are received and added to the furnace to meet a particular feed menu (e.g. hazardous waste installations), longer storage times for particular substances may be beneficial, even of several months in some cases. This allows time for difficult-to-treat wastes to be slowly fed into the system when sufficient compatible materials are also available. Such practices are acceptable where those particular substances are stored in a manner that the risk of substance and container deterioration is well managed.

### 4.1.4.3 Baling or other containment of solid waste

#### Description

During peak delivery times, if the rate of waste receipt is in excess of the plant throughput, waste is wrapped in a plastic cover and stored. Waste received during maintenance or other shutdown periods can also be stored. The technique can facilitate the longer term storage of some wastes and effectively extend the storage capacity of the installation.

Stored wastes can be re-introduced into the main waste flow to the installation when the delivery rate drops, or when the heat output demand is higher, or when energy (electricity or heat) sale prices are higher.

The machinery and materials used for the baling are similar to those used in some areas for the baling of animal feeds. Waste is compacted and wrapped with plastic film in big cylinders, usually about 1 m high by 1 m diameter. The oxygen inside is quickly consumed and no more becomes available as atmospheric air cannot enter a well packed bale, even if the film is torn.

The main advantage of baling and hence the longer-term storage of wastes is that variations in the delivery rate of wastes can be accommodated, and the process can continue running at a steady rate.

#### Achieved environmental benefits

There are 3 main benefits:

- minimisation of the amount of waste to be sent elsewhere - during the shut-downs of the plant or of one of its lines, the waste can be baled and burned later when the plant/line is started again
- Optimisation of plant design. The plant can be operated at a more consistent load conditions all over the year.
- Improvement of the valorisation of recovered energy – the stored waste can be burned when there is greater demand/price for the supplied energy.

#### Cross-media effects

There is a need to adopt suitable measures to manage the following storage related risks:

- odour
- vermin
- litter
- fire risks
- leachate arising from rainwater penetration of the baled wastes.

#### Operational data

City centre sites or other locations where there are adjacent sensitive receptors may mean that the waste storage aspects (e.g. odours) may be more difficult or expensive to manage in an adequate way.

The technique is less likely to be required where there are multiple incineration lines, as such an arrangement can itself provide some level of flexibility of operation through the staggered scheduling of maintenance operations, so that incineration capacity is continually available.

**Applicability**

Applicable in circumstances where waste storage is carried out and it can be undertaken such that it does not give rise to particular concerns regarding cross-media effects (see above). May be applied to non-hazardous industrial solid wastes and either pretreated or mixed MSW, although in practice it is not widely used.

Not suitable to high hazard wastes as the risks (direct or indirect) of longer term storage are likely to outweigh the possible benefits.

**Economics**

Greater income possible from increased energy sales during high demand/high price periods.

The objective of the technique is to ensure that over the course of e.g. a year, costs are reduced by the additional income that is provided by incinerating waste during periods that otherwise it might not (no deliveries) or by ensuring that the waste is burned when there is a higher demand (and hence higher price) for the energy supplied. The technique therefore is likely to find most economical benefit where (a) heat is sold, and (b) there is a variable spot market for energy.

**Driving force for implementation**

Varying energy prices can create a situation where it becomes desirable to bring on line additional incineration capacity to meet this demand – the stored waste can then be used during these periods.

Locations with seasonal populations (e.g. vacation areas) may produce very different amounts of combustible waste depending on the season. The storage of waste allows flexibility, so that the waste can be used when there is spare incineration capacity or additional energy demand.

**Example plants**

The technique is applied in various European MS e.g. Sweden, France.

**Reference literature**

[28, FEAD, 2002] [64, TWGComments, 2003]

**4.1.4.4 Extraction of incineration air from storage areas for odour, dust and fugitive release control****Description**

The incinerator air supply (primary or secondary) can be taken from the waste (or chemical) storage areas. By enclosing the waste storage areas and limiting the size of the entrances to the waste storage areas, the whole waste storage area can be maintained under a slight negative pressure.

This reduces the risk of odour releases and ensures fugitive releases are destroyed in the incinerator rather than released.

It is also possible for raw material storage to be ventilated to either the combustion chamber or to the flue-gas cleaning equipment, depending on the nature of the fumes extracted.

The main techniques employed are:

Technique	Application
Solid waste in enclosed buildings from which incineration air is drawn	<ul style="list-style-type: none"> <li>• municipal wastes</li> <li>• bulky solid and pasty hazardous wastes</li> <li>• RDF</li> <li>• sewage sludges</li> <li>• clinical wastes</li> <li>• other odorous wastes</li> </ul>
Ducting tank vent to incineration air feed	<ul style="list-style-type: none"> <li>• odorous and volatile hazardous wastes e.g. solvent wastes</li> <li>• odorous sludges e.g. sewage sludge</li> <li>• other odorous or volatile wastes</li> </ul>

**Table 4.5: Main techniques for reducing fugitive releases of odour, and GHG emissions.** [2, infomil, 2002] p 150, [1, UBA, 2001] p 36, [40, EURITS, 2003]

### Achieved environmental benefitss

General reduction of fugitive releases, odour, GHG emissions, and sanitary risks.

### Cross-media effects

Alternative air handling and treatment (e.g. for odour, VOC or other substances according to the waste type) measures may be required when the incinerator is not running. Even for multiple line processes where it is usual for at least one line to be running at any particular time, provision of alternative air handling and treatment may be used since it is possible that all lines of a waste incineration plant simultaneously have to stop their operation (e.g. in case of accidents, maintenance of one line and simultaneous breakdown of the other line, end of maintenance when waste is already delivered). [74, TWGComments, 2004]

### Operational data

Typical air requirements for waste incineration processes are 3000 – 10000 m<sup>3</sup>/tonne of treated waste, depending mainly on the LCV.

If air inlets (e.g. doorways, etc) to waste storage areas are smaller (in terms of their combined total cross-sectional area), the inlet velocity of the air across these inlets will be higher and the risk of fugitive releases via these routes consequently lower.

Care is required with extraction from hazardous waste (particularly flammable/volatile material) storage areas in order to avoid explosion risks.

In the case of fire in the bunker, air channels must be automatically closed to prevent fire jumping from bunker into the incineration building.

### Applicability

All incinerators where there is a risk of odour or other substances being released from storage areas.

Plants storing volatile solvents can very significantly reduce their VOC emissions using the technique.

Where applied only for reasons of odour control, locations that are nearer to sensitive odour receptors have a greater need for this technique.

### Economics

Additional ducting costs for retrofits.

The provision of a back-up system for periods when the incinerator is not available entails the additional cost of that system.



**Driving force for implementation**

Control of fugitive releases, including odour.

A proximity to sensitive odour receptors will increase the need for this technique, including the need for alternative measures where the incineration process is not available.

**Example plants**

Widely used at waste incineration plants throughout Europe.

In Germany up to 60 MSWI plants have long experience with this measure.

**Reference literature**

[2, infomil, 2002] p 150, [1, UBA, 2001] p 36, [40, EURITS, 2003] [64, TWGComments, 2003]

**4.1.4.5 Segregation of waste types for safe processing****Description**

Waste acceptance procedures and storage depend on the chemical and physical characteristics of the waste. Appropriate waste assessment is an essential element in the selection of storage and input operations.

This technique is strongly related to the checking, sampling and assessment of incoming wastes outlined in Section 4.1.3.4.

The segregation techniques applied vary according to the type of wastes received at the plant, the ability of the plant to treat those wastes, and the availability of specific alternative treatments or incineration pretreatment. In some cases, particularly for certain reactive mixtures of hazardous wastes, the segregation is required when the materials are packed at the production site, so that they can be packaged, transported, offloaded, stored and handled safely. In these cases, segregation at the incineration installation relates to maintaining the separation of these materials so that hazardous mixtures are avoided. [64, TWGComments, 2003]

Waste type	Segregation techniques
<b>Mixed municipal wastes</b>	<ul style="list-style-type: none"> <li>• segregation is not routinely applied unless various distinct waste streams are received when these can be mixed in the bunker</li> <li>• bulky items requiring pretreatment can be segregated</li> <li>• emergency segregation areas for rejected waste</li> <li>• for fluidised beds, removal of metals may be required to facilitate shredding and prevent blockage.</li> </ul>
<b>Pretreated municipal wastes and RDF</b>	<ul style="list-style-type: none"> <li>• segregation not routinely applied</li> <li>• emergency segregation areas for rejected waste</li> </ul>
<b>Hazardous wastes</b>	<ul style="list-style-type: none"> <li>• extensive procedures required to separate chemically incompatible materials (examples given as follows)</li> <li>• water from phosphides</li> <li>• water from isocyanates</li> <li>• water from alkaline metals</li> <li>• cyanide from acids</li> <li>• flammable materials from oxidising agents</li> <li>• maintain separation of pre-segregated packed delivered wastes</li> </ul>
<b>Sewage sludges</b>	<ul style="list-style-type: none"> <li>• wastes generally well mixed before delivery to plant</li> <li>• some industrial streams may be separately delivered and require segregation for blending</li> </ul>
<b>Clinical wastes</b>	<ul style="list-style-type: none"> <li>• moisture content and CV can vary greatly dependent on source</li> <li>• segregate different containers to allow suitable storage and controlled feeding</li> </ul>

**Table 4.6: Some segregation techniques applied for various waste types**

[2, infomil, 2002] p 150, [1, UBA, 2001] p 36, [40, EURITS, 2003] [64, TWGComments, 2003]

### **Achieved environmental benefits**

Segregating incompatible wastes reduces risks of emissions by:

- reducing accident risks (that may lead to environmental and/or health and safety relevant releases)
- allowing the balanced feeding of substances, thereby avoiding system overloads and malfunctions and thus preventing plant shut down.

### **Cross-media effects**

None identified.

### **Operational data**

In France, legislation requires the storage of clean containers in a separate room from dirty ones.

### **Applicability**

Not applicable where waste is already collected and delivered so that further segregation is not required.

### **Economics**

Information not supplied

### **Driving force for implementation**

Controlling the hazards that may arise from the mixing of incompatible materials and protecting the installation by ensuring that the waste fed to the incinerator falls within the range for which the installation is designed.

### **Example plants**

Information not supplied

### **Reference literature**

[64, TWGComments, 2003]

#### **4.1.4.6 Individual labelling of contained waste loads**

The proper labelling of the wastes (e.g. in accordance with the European Waste Catalogue) that are delivered in containers, assists their continued identification and trace-ability. Identification of wastes, and their source, has the following benefits:

- knowledge of waste content is required for choice of handling/processing operations
- it increases the operators ability to trace sources of problems and then to take steps to eliminate or control them
- ability to demonstrate conformance with restrictions on waste types and quantities received/processed. [64, TWGComments, 2003]

Bar code systems and scan readers can be used for packaged and liquid wastes. The costs of such systems are low in relation to the benefits.

In general, waste delivery is accompanied by a suitable description of the waste; an appropriate assessment of this description and the waste itself forms a basic part of waste quality control. The existence of such a declaration is prescribed in European and other legislation.

An indicative list of the most important parameters for labelling includes:

- name and address of the deliverer
- origin of the waste
- volume
- water and ash content
- calorific value
- concentration of chlorides, fluorides, sulphur and heavy metals.

An example of an adequate description of the waste was developed by the CEN/TC 343 on "Solid Recovered Fuels".

### **Applicability**

Mainly applicable to hazardous waste, clinical waste plants or other situations where wastes are held in containers and have variable/distinct compositions.

### **Example plants**

Labelling is widely applied, particularly at HWIs.

### **Reference literature**

Site visit discussions and [64, TWGComments, 2003]

## **4.1.4.7 The use of fire detection and control systems**

### **Description**

Automatic fire detection systems have been used in waste storage areas as well as for fabric and static bed coke filters, electrical and control rooms, and other identified risk areas.

Automatic fire control systems are applied in some cases, most commonly when storing flammable liquid waste although also in other risk areas.

Foam and carbon dioxide control systems provide advantages in some circumstances e.g. for the storage of flammable liquids. Foam nozzles are commonly used in MSW incineration plants in the waste storage bunker. Water systems with monitors, water cannons with the option to use water or foam, and dry powder systems are also used. Nitrogen blanketing may be used in fixed coke filters, fabric filters, tank farms, or for the pretreatment and kiln loading facilities for hazardous wastes. [74, TWGComments, 2004]

Continuous automatic measurement of temperature can be carried out on the surface of wastes stored in the bunkers. Temperature variations can be used to trigger an acoustic alarm.

There are also other safety devices, such as:

- nozzles above the waste feed hoppers,
- fire resistant walls to separate transformers and retention devices under transformers
- gas detection above gas distribution module.

When ammonia is used, its storage requires specific safety measures: NH<sub>3</sub> detection and water spray devices to absorb releases. [74, TWGComments, 2004]

### **Achieved environmental benefits**

Reduced risk of accidental fugitive releases from fires and explosions.

### **Cross-media effects**

Consumption of nitrogen for blanketing.

Containment is required to prevent the uncontrolled discharge of polluted fire fighting water/chemicals.

### **Operational data**

Use of nitrogen blanketing requires effective operating procedures and containment to avoid operator exposure. Asphyxiation can occur outside enclosed areas as well as inside.

Complementary visual control by operators can be an effective fire detection measure. [74, TWGComments, 2004]

### **Applicability**

The selection of suitable fire prevention, detection and control systems is applicable to all installations.

### **Economics**

Costs are for installation and maintenance. Nitrogen costs, where used.

Prevention of damage by fire can save significant cost. Installation of fire safety measures may reduce insurance premiums.

### **Driving force for implementation**

Safety is a significant driver.

According to a recent European regulation, equipments located in explosive atmosphere should be explosion-proof (electrically + mechanically) [74, TWGComments, 2004]

### **Example plants**

Many plants in Europe. [74, TWGComments, 2004]

### **Reference literature**

[40, EURITS, 2003], [64, TWGComments, 2003]

## **4.1.5 Pretreatment of incoming waste**

### **4.1.5.1 Pretreatment and mixing of wastes**

#### **Description**

Techniques used for waste pretreatment and mixing are wide ranging, and may include:

- mixing of liquid hazardous wastes to meet input requirements for the installation
- shredding, crushing, and shearing of packaged wastes and bulky combustible wastes
- mixing of wastes in a bunker using a grab or other machine (e.g. spreading machines for sewage sludge)
- different grades of shredding of MSW – from
- production of RDF – usually produced from source separated waste and/or other non hazardous waste. [74, TWGComments, 2004]

Mixing of waste may serve the purpose of improving feeding and combustion behaviour. Mixing of hazardous waste can involve risks. Mixing of different waste types may be carried out according to a recipe [74, TWGComments, 2004]

Solid heterogeneous wastes (e.g. municipal and packaged hazardous wastes) can benefit from a degree of mixing in the bunker prior to loading into feed mechanisms.

In bunkers, the mixing involves the mixing of wastes using bunker cranes in the storage bunker itself. Crane operators can identify potentially problematic loads (e.g. baled wastes, discrete items that cannot be mixed or will cause loading/feeding problems) and ensure that these are: removed, shredded or directly blended (as appropriate) with other wastes. The technique is commonly applied at municipal plants and other incinerators where batch loads are delivered for pre-incineration storage in a common bunker. Crane capacity must be designed so that it is sufficient to allow mixing and loading at a suitable rate. Usually there are two cranes, each of them sufficient to cope with the blending and feeding of all the incineration lines.

When special wastes are incinerated together with MSW, they may require specific pretreatment. Clinical waste may be delivered in special packaging, sewage sludge, when not in a relatively small proportion, may require preliminary partial or total drying, and usually specific feeding system e.g. in the feed hopper, in the feed chute, directly in the furnace through a sidewall or above the feeder. [74, TWGComments, 2004]

#### **Achieved environmental benefits**

The burnability of the waste is improved by making it more homogeneous, thus reducing and stabilising emissions from the furnace, and leading to steadier steam/hot water generation in boilers. Although greater homogeneity generally improves the “smoothness” of the operation, the degree of treatment suitable for a given waste type depends upon the nature of the waste and the receiving installation design (i.e. does or will the degree of heterogeneity of the waste lead to particular problems or challenges in the installation, and will the use of additional pretreatment provide sufficient benefit to outweigh the cross-media effects and costs?).

The resultant more even raw flue-gas compositions may allow closer optimisation of the flue-gas cleaning process.

#### **Cross-media effects**

Energy consumption and emissions from the operation of the pretreatment equipment can range widely depending on the nature of the waste, the technique used and the desired feed quality. For example; the production of pelletised RDF from unsorted MSW can require high energy inputs (and, hence, additional costs for the pretreatment), whereas simpler shredding and mixing of selected waste streams can impose a relatively small burden.

#### **Operational data**

The safety of waste blending and crushing operations requires consideration when designing such systems and procedures. This is particularly the case for flammable, toxic, odorous and infectious waste packed in drums. Nitrogen blanketing and air locks for the pretreatment equipment are effective in reducing risks.

Fires and explosions at mechanical sorting and blending plants are a significant risk. However, blending of MSW in the bunker does not cause normally any particular risk. [74, TWGComments, 2004]

The machinery required for the sorting and shredding of heterogeneous wastes is of heavy duty. Effective management and maintenance is required to avoid breakdowns and loss of availability. For thermal processes dealing with MSW which require more than blending, the pretreatment (shredding, shearing, crushing, etc.) must be looked at carefully since it is often a weak point. Special checks should be made on the shredder output because of risk of fire in the shredded waste. [74, TWGComments, 2004]

Mixing of wastes with the objective of achieving compliance with the emission levels in permits is forbidden in some cases (e.g. in Austria).

#### **Applicability**

All plants receiving heterogeneous solid wastes (e.g. untreated municipal and packaged hazardous wastes) can apply the technique in principle.

Significant and adequate pretreatment of municipal solid waste is a prerequisite for some thermal processes. Shredding is not widely applied on MSWI, except for specific combustion designs such as fluidised bed; sometimes double shredding (in series) may be necessary (e.g. pyrolysis plant of Arras, France).

For MSW grate incinerators, the blending of the MSW in the bunker with the crane and grab is considered essential and widely used. However, bulky objects may require removal or, if they are to be incinerated, shredding. Commercial and industrial non-hazardous wastes may require size reduction in order to homogenise the waste. [74, TWGComments, 2004]

The benefits of significant pretreatment are most likely to be realised at new plants that can design the entire incineration installation for the post treated waste.

At existing plants, that have been specifically constructed to allow for wide feedstock flexibility, and are already able to achieve low emission and otherwise good performance levels, the benefits of simple pretreatment may still be seen. However, the adoption of pretreatment techniques that effectively require wholesale changes to the waste collection and pretreatment chain prior to the incineration installation are likely to involve very significant investment in infrastructure and logistics. Such decisions are likely to be beyond the scope of a single installation, and require overall consideration of the entire waste management chain in the region from which wastes are received.

### **Economics**

Costs vary greatly depending on the nature of the waste, the technique used and the desired feed quality.

See also comments under applicability above.

### **Driving force for implementation**

Improved homogeneity of the waste to be incinerated allows better process stability, improved combustion conditions and better process optimisation. Emissions from the incineration installation may, therefore, be reduced, or more closely controlled.

The link to the local waste strategy is important when determining to what extent pretreatment needs to be carried out.

### **Example plants**

All MSWI in Europe blend the MSW in the bunker. Numerous plants are equipped with shear, shredder or crusher for bulky objects, e.g. Toulon

Sewage sludge drying prior to addition with municipal waste is carried out at a number of plants in Europe, e.g. in Nice-Ariane and Bourg St Maurice. It is also carried out without, and fed in the feed chute with MSW e.g. Thiverval, Thumaide, and separately fed into the furnace e.g. Monaco, Bordeaux Bègles, Bordeaux Cenon.

[74, TWGComments, 2004]

### **Reference literature**

[40, EURITS, 2003] and personal communications. [64, TWGComments, 2003]

### 4.1.5.2 Shredding of mixed municipal wastes

#### Description

Untreated mixed municipal waste can be roughly shredded (i.e. not finely shredded) by passing delivered waste through either:

- crocodile shears
- shredders
- mills
- rotor shears
- crushers.

#### Achieved environmental benefits

The homogeneity of the waste is improved, resulting in more even combustion and reduced and more stable emissions from the furnace. Having a more even raw gas composition may allow closer optimisation of the flue-gas cleaning process. Blockages of the feeder systems to the combustor and of bottom ash extraction and transporting systems may also be reduced, hence resulting in reduced downtime and shutdowns.

Shredding of bulky waste added to a municipal waste incineration plant has been reported to improve operation and burnout levels from 3 % TOC to closer to 1 % TOC.

#### Cross-media effects

The shredding equipment is mechanically substantial and results in:

- increased energy consumption for shredder operation
- potential noise - insulation of equipment is required
- production of dusts and odour - controlled ducting of relevant air space to incinerator air supply can be applied
- additional explosion, fire and accident risks
- shredder jamming may cause additional start-up/shut downs and significant periods of unavailability.

Noise, odour and other releases from bulky waste shredding at MSWI plants may be reduced by placing the shredder in the waste reception hall. In some cases the shredding machinery is designed into the bunker itself so that the shredded waste falls directly into the bunker.

#### Operational data

Shredder systems are prone to jamming and physical damage if care is not taken to exclude certain materials.

Operators loading the shredders require specific training to identify problem materials and loads.

Where grate systems are used, the size of the post shredded material will need to be high enough to avoid excessive riddling of the grate. There is, generally, not a minimum size requirement with rotary kilns or fluidised beds. For fluidised beds oversized material tends to be the difficulty, typically due to the blockage of bottom ash extraction or waste feeders, a maximum size of about 50 mm is recommended by some manufacturers. For rotary kilns the size depends on the opening from drum feeding.

#### Applicability

Applicable to all plants receiving heterogeneous solid waste e.g. untreated municipal and packaged hazardous wastes.

The potential environmental benefits of producing a more homogeneous fuel are mainly accrued at the combustion and subsequent stages (e.g. FGT) and need to be weighed against the possible disadvantages of the additional waste treatment (see cross-media effects above). Whether an overall benefit is seen, is greatly dependent upon the nature of the waste received, and the combustion technology employed. At existing installations additional pretreatment may not provide any significant operational or environmental benefits. Grate incinerators are the least likely to achieve major benefits from intensive shredding of mixed MSW, other than the rough shredding of the waste, especially larger components of the waste.

### **Economics**

Additional costs of shredding operation reported to be in the region of EUR 10 per tonne of waste for coarse shredding [16, Energos, 2002]. A higher price of EUR 30 /t is also quoted. [64, TWGComments, 2003]

Savings may be made through the optimisation of the operation of flue-gas treatment plants. Such savings will most likely be possible at new plants, by allowing the selection of smaller flue-gas treatment plants.

### **Driving force for implementation**

Improved stability of combustion process.

### **Example plants**

Several smaller scale (35000 tonnes/yr) municipal plants in Norway (e.g. Energos).

### **Reference literature**

[8, Energos, 2002], [1, UBA, 2001], [64, TWGComments, 2003]

## **4.1.5.3 Shredding of drummed and packaged hazardous wastes**

### **Description**

The pretreatment of liquid packaged waste and packed or bulk solid waste to produce a mixture for continuous feed to the furnace can be carried out. Suitable wastes may be treated to a pumpable state for pumped injection to the kiln or shredded for adding to the storage burner where solids and liquids separate and are then fed to the kiln separately using grabs and pumping respectively.

Pallets containing packaged liquid wastes of low to medium high viscosity are shredded to 5 to 10 cm. The shredded waste may then be screened before being transferred to tanks. Screened out plastics are passed for incineration, ferrous metals are removed using magnets for washing and recycling. In other cases the waste is not screened, and is pumped as a mixture of liquids and shredded solids to the kiln with thinning liquids e.g. waste oils.

The liquid waste is pumped to a conditioning tank where it can be mixed with solvent waste from bulk deliveries to meet viscosity requirements, before final pumping to the furnace.

Packed and bulk solid waste is shredded using a separate line and a heavy-duty cutter shredder. If the power consumption of the shredder is high, this indicates that the consistency of the mixture is becoming too solid for pumping and waste oil is added through a pipeline. If the mixture becomes very thin (low viscosity), bulk solid waste can be added. Piston pumps are used to transfer the mixture to the kiln.

All equipment is sealed under a nitrogen blanket to reduce fire and explosion risks. Air lock doors are used to load the wastes.



**Achieved environmental benefits**

Use of continuous feed:

- improves the combustion performance and reduces peaks of CO and VOCs
- increases average heat recovery due to stable gas flow in boilers
- stabilises conditions for operation of flue-gas cleaning equipment
- prevents explosions in the kiln
- reduces downtime due to refractory etc. damage.

Metals removed before the combustion (see also Section 4.1.5.5) may be of superior quality to those removed after combustion from bottom ashes. This is particularly likely to be the case for those metals removed from higher temperature operations, because of the greater deterioration in quality of post-combustion treated metals that results.

Reduction in consumption of furnace support fuel by 85 % has been achieved in one example [25, Kommunikemi, 2002].

**Cross-media effects**

Energy consumption by shredding and pumping equipment.

**Operational data**

Disadvantages are the demand for better inspection and higher requirements for the quality of the waste to prevent damage and downtime of the shredders. This downtime is compensated for by reductions in maintenance requirements of the furnace due to reduced explosion risks.

**Applicability**

Applicable to incinerators receiving packaged hazardous wastes. The general principle of increasing the homogeneity through suitable waste preparation can be applied to all incinerators where significant variations in raw gas parameters are seen post combustion.

**Economics**

In one example the recycling of packaged steel from a 35 t/d plant produced an additional income of EUR 35000/yr. The number of operators required for handling of packages was reduced from 6 to 3.

Construction costs of two line were reported:

- 35 t/d packaged liquid line = EUR 2.9 million (1990 prices)
- 75 t/d packaged and bulk solid line = EUR 5.4 million (1996 prices).

**Driving force for implementation**

Improved combustion performance leads to reduced emissions. The technique also reduces manual handling of packaged wastes, damage to and maintenance of the kiln.

**Example plants**

Kommunikemi, DK; Ekokem, FIN

**Reference literature**

[25, Kommunikemi, 2002], [20, EKOKEM, 2002] [64, TWGComments, 2003]

**4.1.5.4 Feed equalising control system for solid hazardous wastes****Description**

The feed equaliser itself consists of two robust screw conveyors capable of crushing and feeding solid waste and a tailor made feed hopper for receiving various types of waste. Safety measures are designed according to plant requirements.

Solid bulk waste is fed to the feed hopper with a crab crane through the horizontal feed gates. The feed gates are normally closed to prevent gas leakage into the ambient air.

In the bottom of the feed hopper there are two hydraulically operated feed screws feeding the waste continuously into the feed chute through fire doors. The fire doors prevent back draught from starting fires in the feed hopper.

The feed hopper is equipped with a radioactive source level measurement for the upper and lower fill limits of the hopper. At the upper limit this provides a signal to stop the feed into the hopper.

The lower limit signal slows down the operation of the screws so that there will always be some waste left at the buffer zone in the hopper to act as a barrier between the screw and the feed hopper. The feed hopper works as a buffer zone preventing:

- nitrogen from leaking into the kiln and
- back-draught from causing fire in the feed hoppers.

If there is no need for barrel feeding, the feed equalising system can also feed the waste directly through the front wall of the rotary kiln without a feed hopper.

### **Achieved environmental benefits**

The feed equalising system provides a safe and reliable solution for the controlled continuous feeding of solid hazardous waste, and reduces CO-peaks by ensuring uniform and stable combustion conditions inside the rotary kiln and inside the secondary combustion chamber.

In general, the main environmental benefits are:

- continuous feeding of solid hazardous waste improves the controllability of waste feeding and reduces CO-peaks compared to batch feeding
- optimal utilisation of the incineration capacity of the rotary kiln for low calorific solid hazardous waste
- homogenous stream of molten bottom ash is formed in the rotary kiln at high temperature
- fire safety is improved in the hazardous bunker area by the use of automatic fire extinguishing equipment
- installation of video monitoring equipment enable continuous observation of waste feeding into the rotary kiln.

### **Cross-media effects**

Energy consumption by screw feeders.

### **Applicability**

Applicable to hazardous waste incinerators receiving heterogeneous solid wastes.

### **Economics**

Data not supplied.

Controlled continuous feeding of solid waste into the rotary kiln contributes to efficient use of the maximum incineration capacity.

### **Driving force for implementation**

See environmental benefits above.

**Example plants**

Feed equalising system has been operating successfully at Ekokem in Riihimäki, Finland since 1989, at Sakab in Kumla, Sweden since 1993 and also at A.V.R.-Chemie in Rotterdam, the Netherlands since 1996.

**Reference literature**

[20, EKOKEM, 2002]

**4.1.5.5 Pre-combustion removal of recyclable metals****Description**

Many wastes contain appreciable quantities of ferrous and non-ferrous metals. These can be an inherent part of the waste itself (e.g. food and drink containers in MSW) or arise from the packaging of waste in drums (e.g. hazardous wastes) or other metal containers.

Where the incoming wastes are shredded metals can be removed before incineration to allow recycling.

Metal separation can be achieved by using:

- over-band magnets for large ferrous materials e.g. shredded drums
- drum magnets for small and heavy ferrous items such as batteries, nails, coins, etc.
- eddy current separators for non-ferrous metals – mainly copper and aluminium used for packaging and electrical components.

It may be necessary to wash the removed metals in order to remove contamination from the wastes they have been in contact with. Whether this is necessary, depends on the type of contamination, subsequent storage, transport and recycling process requirements.

Metal separation with reduced oxidation of the metals can also be achieved in fluidised bed gasification plants treating shredded mixed MSW. Here the gasification temperature of 500 – 600 °C and the action of the fluidised bed can together, allow largely un-oxidised metals to be removed from the fluidisation material (e.g. sand) using the same separation technologies described above. The cleaned bed material is re-circulated to the fluidisation chamber.

**Achieved environmental benefits**

The main achieved environmental benefits are:

- recovery of recyclable metal streams
- improved value of metals that have not been partially oxidised at high temperatures in the incinerator
- reduction of content of volatile metals in the flue-gas leading to reduced contamination of flue-gas cleaning residues
- improved bottom ash quality by reduction of metal content (non-volatile fraction).

**Cross-media effects**

Energy required for shredders and operation of separation devices.

Possible consumptions and effluents may arise from washing stages (if used). It may be possible for the contaminated washing effluent to be fed to the incineration process.

### **Operational data**

Operational data regarding shredders is given where available in Sections 4.1.5.3 and 4.1.5.2.

Metal removal may be an essential requirement for certain thermal processes. This process may help preventing risk of fouling of the bed and blockage of the solid discharge due to metal fusion.

In some case. for recovery it may be better to separate the metal after thermal treatment, as the metal with low fusion point are removed. [74, TWGComments, 2004]

### **Applicability**

With MSW in particular, the effective separate collection of these items may mean that greatly reduced quantities of the recoverable metals remain in the waste – making steps to remove these metal at the incineration plant less or not worthwhile.

### **Economics**

There are investment and operational costs associated with the use of the shredding and separation equipment.

With FB combustors shredding may be an essential part of the installation for many waste types (e.g. MSW).

Local market prices determine the income from the recovered metals.

### **Driving force for implementation**

Demand and higher prices for increased quality metal produced improve the economics of such systems. Where outlets already exist for the recovery of post-combustion metals there is a reduced incentive to adopt pre-combustion removal.

### **Example plants**

Hazardous waste: shredding and removal of ferrous drums - Kommunikemi, Denmark

Municipal SW: shredding and removal of Fe and non-Fe scrap - plants in Austria

Municipal SW: example of fluidised bed with pre-shredding, metal ejection and separation – Asahi Clean Centre, Kawaguchi City, Tokyo, Japan

### **Reference literature**

[64, TWGComments, 2003]

## **4.1.5.6 Pretreatment and targeted preparation of solid waste for combustion**

### **Description**

The waste is accepted in different fractions and prepared specifically for incineration. The appropriate crushing and removal of valuable materials (primarily metal) and the merging of the individual fractions using conveyors allows the generation of a standardised, homogeneous fuel.

### **Achieved Environmental Benefits**

Improved combustion through homogenisation of the waste. Reduced pollutant loads, reduced heat value fluctuations and reduced emissions and consumptions from smoother operation.

The intensive mixing of waste before it enters the bunker can improve fuel qualities.

### **Cross-media effects**

Odour, noise and dust emissions from the pretreatment and storage stages. Additional energy consumption associated with the equipment used.

**Operational data**

Improved process operation with the potential for longer component life, particularly for the incineration stage. More even energy generation.

**Applicability**

Mainly applicable to wastes that can be delivered in various fractions or efficiently treated to separate the fractions required.

The technique may be particularly applicable to installation designs that have narrow input specifications e.g. fluidised beds. The benefits of applying the technique may be more limited where an installation is already designed for “mass burn” e.g. grates and rotary kilns.

**Economics**

Cost of separating mixed wastes may be significant. Costs will be reduced where efficient pre-delivery segregation schemes, perhaps coupled with some simple pretreatment, and already in place, allowing only storage and mixing to be carried out at the incineration installation.

**Driving force for implementation**

Availability of pre-selected waste streams e.g. from prior segregation of the waste before delivery to the installation, which then do not need to be separated and may be stored separately.

**Example plants**

RMVA Cologne, Germany

**Reference literature**

[64, TWGComments, 2003]

**4.1.6 Waste transfer and loading****4.1.6.1 Positioning and view of operator**

The operators of waste feed systems need to have a good view of waste storage and loading areas and their mechanisms to monitor them. This can be achieved by positioning the control room with a view of the combustor loading areas and by the use of video monitors or other detection systems. The former is preferable unless there are particular safety or other technical reasons why this cannot be achieved.

[64, TWGComments, 2003]

**4.1.6.2 Provision of storage space for items removed from the waste**

Some waste streams commonly require the removal of certain components of the waste, usually because they are unsuitable for processing in the facility. Suitable storage needs to be provided for these items. See also Section 4.1.3

**4.1.6.3 Direct injection of liquid and gaseous hazardous wastes in rotary kilns****Description**

Liquid, pasty and gaseous wastes can be fed directly to rotary kilns via several direct feeding lines. In 2002, almost 8.5 % of the total waste incineration in rotary kilns consisted of liquid waste processed through direct injection lines. Each rotary kiln has several direct feeding lines.

In general, the direct injection operation is done by connecting the waste container and the feeding line and pressurising the container with nitrogen or in case of sufficiently low viscosity by emptying the container with appropriate pumps. In this way, the liquid waste is fed into the processing line. Depending on the calorific value of the liquid waste, it is injected either at the front of the rotary kiln or into the post combustion chamber.

Depending on which direct injection line is used, after processing the line can be purged with nitrogen, fuel, waste oil or steam.

Multi-purpose and dedicated injection lines are used, largely depending on the substances to be incinerated.

### **Achieved environmental benefits**

Prevention of diffuse air emissions due to the fact that the waste is fed by a complete closed system.

### **Cross-media effects**

Use of nitrogen and steam.

### **Operational data**

The direct injection lines allow the incineration of liquid wastes that have properties that exclude other processing possibilities.

Appropriate materials/linings are required for feeder lines, with heating required in some cases.

Feed rate capacity ranges depend upon incineration process factors (e.g. thermal capacity and FGT capacity) but can range from 50 – 1500 kg/hr.

Injection can be via dedicated lance or multi-fuel burner.

### **Applicability**

Applicable to liquid hazardous wastes, particularly those that present health and safety handling risks that require minimal worker exposure.

### **Economics**

An average investment price for a dedicated line amounts to EUR 100000 - 200000.

### **Driving force for implementation**

The need to feed toxic, odorous, reactive and corrosive liquids and gases safely.

### **Example plants**

Indaver, Antwerp plant (Belgium)

HIM, Biebesheim plant (Germany) and GSB, Ebenhausen plant (Germany).

### **Reference literature**

[64, TWGComments, 2003]

#### **4.1.6.4 Reduction of air ingress into the combustion chamber during loading**

The use of systems that prevent air ingress to the combustion chamber helps to maintain process stability and reduce emissions.

Such systems include:

- maintaining a filled hopper for solid wastes
- use of enclosed screw feeders
- use of interlocked double doors for batch loading
- use of pumped direct injection for liquid and pasty wastes.

---

## 4.2 Thermal processing

### 4.2.1 Combustion technology selection

#### **Description**

A combustion (or thermal treatment) stage, that is technically suited to the material that will be fed to the process, is required. The application of a technology developed for a different waste of unsuitable characteristics can often result in poor or unreliable performance. See comments in Section 4.1.1 regarding the need for the selection of a process suited to the waste to be received.

Tables 4.7, 4.8 and 4.9 below together provide a comparison of the main applied combustion and thermal treatment technologies and factors affecting their applicability and operational suitability. It is important to note that, whilst applied in the sector, the degree of demonstration of the technologies listed varies, as does the nature of the waste to which they have been applied successfully:

Technique	Key waste characteristics and suitability	Throughput per line	Operational/Environmental information		Bottom ash quality	Flue-gas volume	Cost information
			Advantages	Disadvantages/limitations of use			
<b>Moving grate - air-cooled</b>	<ul style="list-style-type: none"> <li>low to medium heat values (LCV 5 – 16.5 GJ/t)</li> <li>municipal and other heterogeneous solid wastes</li> <li>can accept a proportion of sewage sludge and/or medical waste with municipal waste</li> <li>applied at most modern MSW installations</li> </ul>	1 to 50 t/h with most projects 5 to 30 t/h. Most industrial applications not below 2.5 or 3 t/h.	<ul style="list-style-type: none"> <li>very widely proven at large scales</li> <li>robust - low maintenance cost</li> <li>long operational history</li> <li>can take heterogeneous wastes without special preparation</li> </ul>	generally not suited to powders, liquids or materials that melt through the grate	<ul style="list-style-type: none"> <li>TOC 0.5 % to 3 %</li> </ul>	4000 to 7000 Nm <sup>3</sup> /t waste input. Depends upon the LCV. Typically 5200 Nm <sup>3</sup> /t.	High capacity reduces specific cost per tonne of waste
<b>Moving grate - liquid cooled</b>	Same as air-cooled grates except: <ul style="list-style-type: none"> <li>LCV 10 – 20 GJ/t</li> </ul>	1 to 50 t/h with most projects 5 to 30 t/h. Most industrial applications not below 2.5 or 3 t/h	As air-cooled grates but: <ul style="list-style-type: none"> <li>higher heat value waste treatable</li> <li>better combustion control possible</li> </ul>	As air-cooled grates but: <ul style="list-style-type: none"> <li>risk of grate damaging leaks</li> <li>higher complexity</li> </ul>	<ul style="list-style-type: none"> <li>TOC 0.5 % to 3 %</li> </ul>	4000 to 7000 Nm <sup>3</sup> /t waste input. Depends upon the LCV. Typically 5200 Nm <sup>3</sup> /t.	Slightly higher capital cost than air-cooled
<b>Grate plus rotary kiln</b>	Same as other grates except: <ul style="list-style-type: none"> <li>can accept very heterogeneous waste and still achieve effective burnout</li> <li>not widely used</li> </ul>	1 to 10 t/h	<ul style="list-style-type: none"> <li>improved burnout of bottom ash possible</li> </ul>	<ul style="list-style-type: none"> <li>throughput lower than grate only</li> <li>maintenance of rotary kiln</li> </ul>	<ul style="list-style-type: none"> <li>TOC 0.5 % to 3 %</li> </ul>	4000 to 7000 Nm <sup>3</sup> /t waste input. Depends upon the LCV. Typically 5200 Nm <sup>3</sup> /t.	Higher capital and revenue costs
<b>Static grate with ash/waste transport mechanism</b>	<ul style="list-style-type: none"> <li>municipal wastes require selection or some shredding</li> <li>less problems with powders etc. than moving grates</li> </ul>	Generally low <1 t/h	<ul style="list-style-type: none"> <li>lower maintenance - no moving parts</li> </ul>	<ul style="list-style-type: none"> <li>only for selected/pre-treated wastes</li> <li>lower throughput</li> <li>some static grates require support fuel</li> </ul>	<ul style="list-style-type: none"> <li>&lt;3 % with prepared waste</li> </ul>	Slightly lower than other grate systems where staged combustion used (higher if support fuel used)	Competitive with moving grates at small scales (<100 Kt/y).

Table 4.7: A comparison of combustion and thermal treatment technologies and factors affecting their applicability and operational suitability (table 1/3) [24, CEFIC, 2002] [2, infomil, 2002] [10, Juniper, 1997] [8, Energos, 2002] [1, UBA, 2001] [64, TWGComments, 2003]



Technique	Key waste characteristics and suitability	Throughput range (per line)	Operational/Environmental information		Bottom ash quality	Flue-gas volume	Cost information
			Advantages	Disadvantages			
<b>Rotary Kiln</b>	<ul style="list-style-type: none"> <li>can accept liquids and pastes</li> <li>solid feeds more limited than grate (owing to refractory damage)</li> <li>often applied to hazardous wastes</li> </ul>	<10 t/h	<ul style="list-style-type: none"> <li>very well proven</li> <li>broad range of wastes</li> <li>good burn out - even of HW</li> </ul>	Throughputs lower than grates	<ul style="list-style-type: none"> <li>TOC &lt;3 %</li> </ul>	6- 10000 m <sup>3</sup> / t waste input	Higher specific cost due to reduced capacity
<b>Rotary kiln (cooled jacket)</b>	As rotary but: <ul style="list-style-type: none"> <li>higher CV wastes possible due to greater temperature tolerance</li> </ul>	<10 t/h	<ul style="list-style-type: none"> <li>very well proven</li> <li>can use higher combustion temperatures (if required)</li> <li>better refractory life than un-cooled kiln</li> </ul>	Throughput lower than grates	<ul style="list-style-type: none"> <li>low leaching vitrified slag</li> </ul>	6- 10000 m <sup>3</sup> / t waste input	Higher specific cost due to reduced capacity
<b>Fluid bed - bubbling</b>	<ul style="list-style-type: none"> <li>only finely divided consistent wastes. Limited use for raw MSW</li> <li>often applied to sludges</li> </ul>	1 to 10 t/h	<ul style="list-style-type: none"> <li>good mixing</li> <li>fly ashes of good leaching quality</li> </ul>	<ul style="list-style-type: none"> <li>careful operation required to avoid clogging bed</li> <li>Higher fly ash quantities.</li> </ul>	<ul style="list-style-type: none"> <li>TOC &lt;3 %</li> </ul>	Relatively lower than grates	FGT cost may be lower. Costs of waste preparation
<b>Fluid bed - Rotating</b>	<ul style="list-style-type: none"> <li>wide range of heat values (7 - 18 MJ/kg)</li> <li>coarsely shredded MSW may be treated</li> <li>combined incineration of sludge</li> </ul>	3 to 22 t/h	<ul style="list-style-type: none"> <li>good mixing/high turbulence</li> <li>wide range of LCV</li> <li>high burnout, dry bottom ash</li> </ul>	<ul style="list-style-type: none"> <li>shredding of MSW required</li> <li>higher fly ash quantity than grates</li> </ul>	<ul style="list-style-type: none"> <li>TOC &lt;3 %</li> <li>often 0.5 - 1 %</li> </ul>	4000 to 6000Nm <sup>3</sup> /t	
<b>Fluid bed - circulating</b>	<ul style="list-style-type: none"> <li>only finely divided consistent wastes. Limited use for raw MSW</li> <li>often applied to sludges/RDF</li> </ul>	1 to 20 t/h most used above 10 t/h	<ul style="list-style-type: none"> <li>good mixing</li> <li>greater fuel flexibility than BFB</li> <li>fly ashes of good leaching quality</li> </ul>	<ul style="list-style-type: none"> <li>cyclone required to conserve bed material</li> <li>Higher Flying ashes quantities</li> </ul>	<ul style="list-style-type: none"> <li>TOC &lt;3 %</li> </ul>	Relatively lower than grates	FGT cost may be lower. Costs of preparation.

Table 4.8: A comparison of combustion and thermal treatment technologies and factors affecting their applicability and operational suitability (table 2/3) [24, CEFIC, 2002] [2, infomil, 2002] [10, Juniper, 1997] [8, Energos, 2002] [1, UBA, 2001] [64, TWGComments, 2003]

Technique	Key waste characteristics and suitability	Throughput range (per line)	Operational/Environmental information		Bottom ash quality	Flue-gas volume	Cost information
			Advantages	Disadvantages			
<b>Oscillating furnace</b>	<ul style="list-style-type: none"> <li>MSW</li> <li>heterogeneous wastes</li> </ul>	1 – 10 t/h	<ul style="list-style-type: none"> <li>robust - low maintenance</li> <li>long history</li> <li>low NO<sub>x</sub> level</li> <li>low LOI of bottom ash</li> </ul>	<ul style="list-style-type: none"> <li>higher thermal loss than with grate furnace</li> <li>LCV under 15 G/t</li> </ul>	<ul style="list-style-type: none"> <li>TOC 0.5 – 3 %</li> </ul>	<i>Information not supplied</i>	Similar to other technologies
<b>Pulsed hearth</b>	<ul style="list-style-type: none"> <li>only higher CV waste (LCV &gt;20 GJ/t)</li> <li>mainly used for clinical wastes</li> </ul>	<7 t/h	<ul style="list-style-type: none"> <li>can deal with liquids and powders</li> </ul>	<ul style="list-style-type: none"> <li>bed agitation may be lower</li> </ul>	<ul style="list-style-type: none"> <li>dependent on waste type</li> </ul>	<i>Information not supplied</i>	Higher specific cost due to reduced capacity
<b>Stepped and static hearths</b>	<ul style="list-style-type: none"> <li>only higher CV waste (LCV &gt;20 GJ/t)</li> <li>mainly used for clinical wastes</li> </ul>	Information not supplied	<ul style="list-style-type: none"> <li>can deal with liquids and powders</li> </ul>	<ul style="list-style-type: none"> <li>bed agitation may be lower</li> </ul>	<ul style="list-style-type: none"> <li>dependent on waste type</li> </ul>	<i>Information not supplied</i>	Higher specific cost due to reduced capacity
<b>Spreader - stoker combustor</b>	<ul style="list-style-type: none"> <li>RDF and other particle feeds</li> <li>poultry manure</li> <li>wood wastes</li> </ul>	Information not supplied	<ul style="list-style-type: none"> <li>simple grate construction</li> <li>less sensitive to particle size than FB</li> </ul>	<ul style="list-style-type: none"> <li>only for well defined mono-streams</li> </ul>	<ul style="list-style-type: none"> <li><i>Information not supplied</i></li> </ul>	<i>Information not supplied</i>	<i>Information not supplied</i>
<b>Gasification - fixed bed</b>	<ul style="list-style-type: none"> <li>mixed plastic wastes</li> <li>other similar consistent streams</li> <li>gasification less widely used/proven than incineration</li> </ul>	to 20 t/h	<ul style="list-style-type: none"> <li>low leaching residue</li> <li>good burnout if oxygen blown</li> <li>syngas available</li> <li>reduced oxidation of recyclable metals</li> </ul>	<ul style="list-style-type: none"> <li>limited waste feed</li> <li>not full combustion</li> <li>high skill level</li> <li>tar in raw gas</li> <li>less widely proven</li> </ul>	<ul style="list-style-type: none"> <li>low leaching bottom ash</li> <li>good burnout with oxygen</li> </ul>	Lower than straight combustion	High operation/ maintenance costs
<b>Gasification - entrained flow</b>	<ul style="list-style-type: none"> <li>mixed plastic wastes</li> <li>other similar consistent streams</li> <li>not suited to untreated MSW</li> <li>gasification less widely used/proven than incineration</li> </ul>	to 10 t/h	<ul style="list-style-type: none"> <li>low leaching slag</li> <li>reduced oxidation of recyclable metals</li> </ul>	<ul style="list-style-type: none"> <li>limited waste feed</li> <li>not full combustion</li> <li>high skill level</li> <li>less widely proven</li> </ul>	<ul style="list-style-type: none"> <li>low leaching slag</li> </ul>	Lower than straight combustion	High operation/ maintenance costs pretreatment costs high

Technique	Key waste characteristics and suitability	Throughput range (per line)	Operational/Environmental information		Bottom ash quality	Flue-gas volume	Cost information
			Advantages	Disadvantages			
<b>Gasification - fluid bed</b>	<ul style="list-style-type: none"> <li>• mixed plastic wastes</li> <li>• shredded MSW</li> <li>• shredder residues</li> <li>• sludges</li> <li>• metal rich wastes</li> <li>• other similar consistent streams</li> <li>• gasification less widely used/proven than incineration</li> </ul>	5 – 20 t/h	<ul style="list-style-type: none"> <li>• can use low reactor temperatures e.g. for Al recovery</li> <li>• separation of main non-combustibles</li> <li>• can be efficiently combined with ash melting</li> <li>• reduced oxidation of recyclable metals</li> </ul>	<ul style="list-style-type: none"> <li>• limited waste size (&lt;30cm)</li> <li>• tar in raw gas</li> <li>• higher UHV raw gas</li> <li>• less widely proven</li> </ul>	<ul style="list-style-type: none"> <li>• if combined with ash melting chamber ash is vitrified</li> <li>• ash quality without ash chamber – info. not supplied</li> </ul>	Lower than straight combustion	Lower than other gasifiers
<b>Pyrolysis - short drum</b>	<ul style="list-style-type: none"> <li>• pretreated MSW</li> <li>• high metal inert streams</li> <li>• shredder residues/plastics</li> </ul>	~ 5 t/h	<ul style="list-style-type: none"> <li>• no oxidation of metals</li> <li>• no combustion energy for metals/inert</li> <li>• in reactor acid neutralisation possible</li> <li>• syngas available</li> </ul>	<ul style="list-style-type: none"> <li>• limited wastes</li> <li>• process control and engineering critical</li> <li>• high skill req.</li> <li>• not widely proven</li> <li>• need market for syngas</li> </ul>	<ul style="list-style-type: none"> <li>• dependent on process temperature</li> <li>• residue produced requires further processing sometimes combustion</li> </ul>	Very low due to low excess air required for gas combustion	High pretreatment, operation and capital costs
<b>Pyrolysis - medium drum</b>	<ul style="list-style-type: none"> <li>• pyrolysis is less widely used/proven than incineration</li> </ul>	5 – 10 t/h					

**Table 4.9: A comparison of combustion and thermal treatment technologies and factors affecting their applicability and operational suitability (table 3/3) [24, CEFIC, 2002] [2, infomil, 2002] [10, Juniper, 1997] [8, Energos, 2002] [1, UBA, 2001] [64, TWGComments, 2003]**

## 4.2.2 Use of flow modelling

### Description

Physical and/or computer models may be used to investigate the effect of design features. Various parameters may be investigated including gas velocities and temperatures inside the furnace and boiler. Gas flow through FGT systems may also be studied with a view to improving their efficiency e.g. SCR units.

Computerised Fluid Dynamics (CFD) is an example of modelling tool that may be used to predict gas flows. Using such techniques can assist in the selection of a design that will allow optimisation of the gas flows, so as to encourage effective combustion conditions and avoid long gas residence times in those temperature zones, which may otherwise increase the risks of PCDD/F formation. By applying the technique to FGT systems design it may be used to improve performance e.g. by ensuring even flow across SCR catalyst mesh.

Modelling has been successfully used at both new and existing incineration plants to:

- optimise furnace and boiler geometry
- optimise the positioning of secondary and/or flue-gas re-circulation air (if used)
- optimise the reagent injection points for SNCR NO<sub>x</sub> reduction
- optimise gas flow through SCR units.

### Achieved environmental benefits

The optimisation of furnace design may enhance the combustion performance and therefore limit the formation of CO, TOC, PCDD/F and/or NO<sub>x</sub> (i.e. combustion related substances). There is no effect on other, waste contained, pollutants. [64, TWGComments, 2003]

Reduction of fouling due to excessive local flue-gas velocities by using CFD modelling can increase the availability of plants and improve the energy recovery over time.

Improvement in performance of abatement equipment.

### Cross-media effects

Improving performance at the combustion stage may allow the selection of gas cleaning equipment with reduced emissions and consumptions.

### Operational data

The improvements of the flue-gas flow distribution along the boiler helps to reduce erosion and fouling leading to corrosion.

### Applicability

The technique is applicable to:

- new waste incineration projects – to optimise design
- existing plants where concerns exist regarding the combustion and boiler design - this will allow the operator to investigate and prioritise optimisation possibilities
- existing plants undergoing alterations in the furnace/boiler
- new and existing plants investigating the positioning of secondary/flue-gas re-circulation air injection equipment
- installations installing or using SCR – to optimise the SCR unit itself.

### Economics

Typically, a computer optimisation study will cost in the region of EUR 10000 to 30000, depending on the scope of the study and the number of modelling runs required.

Savings in investment and operational costs may arise from:

- selection of alternative abatement system technology options
- smaller/less complex abatement systems
- lower consumptions by the abatement system.

The savings noted above are less likely to be realised where the key design issues for the selection of the abatement system is the presence of heavy metals or halogens e.g. hazardous waste plants. This is because the driver for FGT design in these cases is normally the loading of intractable substances rather than combustion related substances.

Significant costs can be associated with modifying the furnace or boiler design of existing installations.

#### **Driving force for implementation**

Optimisation of combustor design for low raw gas pollutant concentrations and possible reduced emissions and consumptions.

#### **Example plants**

The technique has been used at:

- the application stage in the UK to demonstrate effective combustion design of a proposed installation
- to optimise the combustion stage design at small municipal plants in Norway
- for some new and existing municipal plants in Belgium
- French plants: St Ouen (1989) - Nancy(1995) - Toulouse - St Germain.

#### **Reference literature**

[15, Segers, 2002], [16, Energos, 2002], [17, ONYX, 2000], [64, TWGComments, 2003]

### **4.2.3 Combustion chamber design features**

#### **Description**

For some furnace types, including grates and static kilns, options exist regarding the positioning and shape of the exit from the primary combustion chamber to secondary combustion zones. A design that is not appropriate would lead to poor retention of combustible gases in the combustion zones, poor gas phase burnout and higher emissions.

The design of the exit from the first stage of the furnace to the gas combustion and burnout zone (the throat) should be selected to compliment the waste composition and other components of the furnace e.g. grate type. See text in Section 2.3.1.4 and Figure 2.7.

For grate incineration, the design of the combustion chamber is closely linked to the supplier of the grate. Suppliers can optimise the combination of grate and combustion chamber, based on the individual performance of their system and experience. There is, generally, no overall advantage/disadvantage from one design of combustion chamber to the other - all can be applied. Furthermore, combustion chamber design cannot usually be chosen independently from grate selection; together these form a clear and non-separable unit. [64, TWGComments, 2003]

CFD modelling (see 4.2.2) may be helpful in designing the combustion chamber.

Type	Design features	Comments
Co-current or parallel flow	<ul style="list-style-type: none"> <li>exit to combustion chamber at end of furnace</li> <li>gas flow in same direction as waste movement</li> </ul>	<ul style="list-style-type: none"> <li>suited to higher NCV wastes</li> <li>all evolved gases must pass through maximum temperature zone and have long retention time</li> <li>primary air heating required in ignition zone</li> </ul>
Countercurrent or counter-flow	<ul style="list-style-type: none"> <li>exit to combustion chamber at start of furnace</li> <li>gas flow in opposite direction to the waste</li> </ul>	<ul style="list-style-type: none"> <li>suited to low NCV/high moisture/high ash waste (as hot gases from volatilisation zone pass over the drying zone)</li> <li>higher secondary air requirements to ensure gas burnout</li> </ul>
Central current or central flow	<ul style="list-style-type: none"> <li>exit to combustion chamber in middle of furnace</li> </ul>	<ul style="list-style-type: none"> <li>compromise of the above for wide spectrum of waste</li> <li>furnace configuration/secondary air important to ensure gas burnout.</li> </ul>
Split flow	<ul style="list-style-type: none"> <li>exit from combustion chamber in mid position but split by central section</li> </ul>	<ul style="list-style-type: none"> <li>central section aids retention of gases and allows secondary air to be injected from additional locations</li> <li>mainly used for very large dimension furnace</li> </ul>

**Table 4.10: A comparison of the features of some different furnace geometries**  
[1, UBA, 2001, 2, infomil, 2002, 4, IAWG, 1997, 15, Segers, 2002]

#### Achieved environmental benefits

Improved combustion results in lower emissions to all media and reduced consumptions.

#### Cross-media effects

No significant negative effects identified.

#### Operational data

The combustion chamber is usually supplied with the grate and optimised for the particular grate type that is selected. Combustion chamber design is therefore dependent upon the grate selection. Each system described in Table 4.10 can result in operational improvements when suitably applied.

#### Applicability

These techniques are generally applicable to most incinerator designs, except rotary kilns where the exit to the secondary combustion chamber is always at the end of the kiln. However with rotary kilns, the sizing and shape of the connection to the secondary chamber and the positioning of the secondary air injection should also be such that it provides for sufficient gas retention and mixing, to encourage gas burnout (as indicated by low and steady PIC concentrations).

Split flow systems are mainly applicable to larger dimension furnaces because of the additional secondary air mixing it allows in central positions of the furnace. In smaller furnaces, adequate mixing may be achieved using sidewall injection of the secondary air.

A balanced overall combustion chamber design ensures that gases evolved from the waste are well mixed and retained at sufficient temperature in the combustion chamber to allow the combustion process to be fully completed. This principle is applicable to all incineration processes.

#### Economics

At new plants the combustion chamber design features can be optimised at the outset. The additional costs of such design refinements may then be small in relation to the overall cost of the project.

At existing plants the cost of redesigning (usually this means replacing) the furnace is very high and may often outweigh the benefits to be achieved unless there are very serious difficulties with the combustion stage, or the relevant equipment is due to be replaced for other reasons.

#### **Driving force for implementation**

Reductions in emissions from effective combustion.

#### **Example plants**

All plants select one of these options.

Split flow has been applied at: Indaver, BE, AZN (Afvalverbranding Zuid-Nederland, Moerdijk, The Netherlands) as well as the Bonn-plant (Germany) and the Mke-line of MVV (Mannheim, Germany).

#### **Reference literature**

[1, UBA, 2001, 2, infomil, 2002, 4, IAWG, 1997, 15, Segers, 2002, 64, TWGComments, 2003]

### **4.2.4 Design to increase turbulence in the secondary combustion chamber**

#### **Description**

See also related techniques in sections:

4.2.11 Secondary air injection, optimisation and distribution,

4.2.12 Replacement of part of the secondary air with re-circulated flue-gas

4.2.19 Optimisation of time, temperature, turbulence of gases in the combustion zone, and oxygen concentrations

This technique relates to design features that increase the turbulence and hence mixing of combustion gases in the zone after the primary combustion zone, but before or at the start of the main heat recovery areas when the gas temperatures will generally still exceed approx. 850 °C. After the zone being considered here, as the combustion gases may pass onwards through the main heat recovery areas (exchangers), stable and even gas velocity and flow are required to prevent gas counter-flow and circulation that might lead to heat exchange problems and pollutant generation.

In some cases, special configurations of the Secondary Combustion Area (SCA) can be used to increase turbulence in the secondary combustion chamber. Examples of designs include:

- vortex chambers
- inclusion of baffles (cooling required)
- several passes and turns in the chamber
- tangential secondary air input
- location and position of the secondary air injection systems (nozzles, ...).

#### **Achieved environmental benefits**

Improved combustion leading to lower raw gas concentrations of combustion related parameters.

This technique can reduce the volume of secondary air required, and hence reduce overall flue-gas volumes and NO<sub>x</sub> production. Effective turbulence will also result in improved burnout of combustion gases with reduced VOC and CO levels

#### **Cross-media effects**

None identified.

#### **Operational data**

Information not supplied

### **Applicability**

The SCC is designed by the supplier at the design stage. Additional features might appear necessary with some furnace designs for some type of waste. [74, TWGComments, 2004]

The use of additional physical features to increase mixing is currently mainly applied in the HWI industry.

### **Economics**

Information not supplied

### **Driving force for implementation**

Information not supplied

### **Example plants**

Hazardous wastes - Cleanaway UK.

### **Reference literature**

[40, EURITS, 2003] [64, TWGComments, 2003]

## **4.2.5 Use of continuous rather than batch operation**

### **Description**

Emissions at incineration plants are easier to control during routine operation than during start-up and shutdown operations. Reducing the number of start-ups and shutdowns required is, therefore, an important operational strategy that can reduce overall emissions and consumptions. Waste collection/delivery regime and seasonal waste generation fluctuations can cause shutdowns through lack of wastes, although they are often avoided by running the plant at partial load in order to deal with such fluctuations. Running at partial load normally does not cause problems for a modern combustor. [74, TWGComments, 2004]

Factors that help to achieve continuous throughput include:

- the process design throughput rate is similar to the rate at which waste is received
- waste storage (where possible) may cover slow periods
- organisation of the supply chain to prevent slow periods
- supplementing waste feed with additional fuels
- use of online cleaning.

Sizing and maintaining plants to maximise continuous running is, therefore, important.

### **Achieved environmental benefits**

Consistent plant operation improves energy efficiency.

### **Cross-media effects**

Energy efficiency can be reduced by continuous operation on a lower load, because turbine efficiency is lower.

### **Operational data**

Predicting and controlling waste flows to the plant are important.

Good maintenance is important for avoiding/limiting shut downs. On line maintenance programme can be designed into the installation so that availability is maximised.

### **Applicability**

Planning for and achieving a reduced number of shutdowns is likely to reduce the annual mass emission levels of any plant.



**Economics**

Avoiding shutdowns can reduce costs at the incineration installations by:

- allowing continuous throughput and hence greater installation utilisation
- decreasing furnace maintenance due to lower thermal stress on the process
- avoiding capital costs of an unnecessarily large processes.

Where the capacity of the installation is larger than the quantity of the waste received, and the decision is taken to supplement the throughput with other wastes or fuels, there may be costs associated with the purchase of those fuels/wastes.

**Driving force for implementation**

Main driving forces are operational.

**Example plants**

In general all large waste incineration plants are operated continuously. MSWI plants of an industrial size (above ~2 t/h) can be operated continuously with a minimum number of shutdowns.

**Reference literature**

[28, FEAD, 2002] [64, TWGComments, 2003]

## 4.2.6 Selection and use of suitable combustion control systems and parameters

**Description**

[2, infomil, 2002]

The incineration of wastes of variable composition requires a process that can cope with large variations in process conditions. When unfavourable process conditions occur, interventions in operational control are required.

In order to be able to control the incineration process, detailed process information is required, a control system ('philosophy') must be designed, and it is necessary to be able to intervene in the process. The details of the systems used, vary from plant to plant. The following provides an overview of process information, control philosophy systems and process interventions that can be used.

Process information may include:

- grate temperatures for various positions
- thickness of waste layer on the grate (visual control)
- pressure drop over the grate
- furnace and flue-gas temperatures at various positions
- determination of temperature distribution over the grate surface by optic or infrared measurement systems
- CO-, O<sub>2</sub>-, CO<sub>2</sub>- and/or H<sub>2</sub>O-measurements (at various positions)
- steam production data (e.g. temperature, pressure)
- openings in the combustion wall for visual observation by individuals or camera
- length and position of the fire in the furnace
- emissions data for combustion related substances (unabated levels).

[74, TWGComments, 2004]

The control philosophy may be a classic control system, which may already be included in the process control computer. Additionally, fuzzy control systems are applicable.

Control interventions include adjusting :

- the dosing system for the waste
  - frequencies and speed of grate movements in various parts of the grate
  - amount and distribution of primary air
  - temperature of the primary air (if preheating facilities are available)
  - amount and distribution of secondary air in the furnace (and, if available, of re-circulation gas)
  - the ratio primary to secondary air.
- [74, TWGComments, 2004]

### **Achieved environmental benefits**

The use of sophisticated control systems can result in an incineration process that has less variations in time (i.e. improved stability) and space (i.e. more homogeneous) thus allowing for improved overall combustion performance and reduced emissions to all media.

Improved process control has the following specific advantages:

- better bottom ash quality (due to sufficient primary air distribution and a better positioning of the incineration process on grates)
- less fly ash production (due to less variations in the amount of primary incineration air)
- better fly ash quality (less unburned material, due to more stable process conditions in the furnace)
- less CO and VOC -formation (due to more stable process conditions in the furnace; i.e. no 'cold' spots)
- less NO<sub>x</sub> formation (due to more stable process conditions in the furnace; i.e. no 'hot' spots)
- less risks of formation of dioxin (and precursors) due to a more stable process in the furnace
- better utilisation of the capacity (because the loss of thermal capacity by variations is reduced)
- better energy efficiency (because the average amount of incineration air is reduced)
- better boiler operation (because the temperature is more stable, there are less temperature 'peaks' and thus less risk of corrosion and clogging fly ash formations)
- better operation of the flue-gas treatment system (because the amount and the composition of the flue-gases is more stable)
- higher destruction potential, combined with more effective combustion of the waste. [74, TWGComments, 2004]

The indicated advantages also result in less maintenance and thus better plant availability.

### **Cross-media effects**

None identified.

### **Operational data**

Grate bar temperature may be measured using thermocouples. Flue-gas temperatures are more difficult to measure due to severe conditions - high level of dust, risk of metal melting, etc. Measurements at the furnace outlet are also not easy to implement due to operational conditions (dust, acid, etc.), in particular for CO and CO<sub>2</sub> measurements. For control purposes, quick measurements are required. It is very difficult to measure H<sub>2</sub>O accurately. [64, TWGComments, 2003]

### **Applicability**

Selection and use of suitable combustion control systems and parameters is applicable to all waste incineration installations. The detailed components of such a system will vary from one process design to another. Most of the specific techniques in the description section above are applicable to grate rather than other incinerators.

The technique is of particular benefit where the waste fed to the furnace is highly heterogeneous in nature, i.e. of variable composition, or its quality is difficult to predict or assure.

### Economics

The indicated advantages also result in less maintenance and, therefore, better plant availability.

### Driving force for implementation

The improved combustion performance results in overall improvements in environmental performance.

### Example plants

Widely employed throughout Europe particularly at modern plants.

### Reference literature

[2, infomil, 2002] [64, TWGComments, 2003]

## 4.2.7 Use of infrared cameras for combustion monitoring and control

### Description

The continuous adaptation of the distribution and amount of incineration air to match the precise incineration reaction requirements in the individual zones of the furnace can improve the incineration process. An infrared camera is an example of a techniques that can be used to create a thermal image of the burning waste bed. Ultra-sound and visual cameras are also used. The temperature distribution on the grate appears on a screen as an isothermal field graduated in coloured areas.

For the subsequent furnace performance control, the characteristic temperatures of the individual grate zones may be determined and passed on to the furnace performance controller as input parameters for furnace variables. Using fuzzy logic, some variables (e.g. temperature, CO, O<sub>2</sub> content) and a sequence of rules can be determined to maintain the process within these settings. In addition, flue-gas re-circulation and tertiary air addition can be controlled.

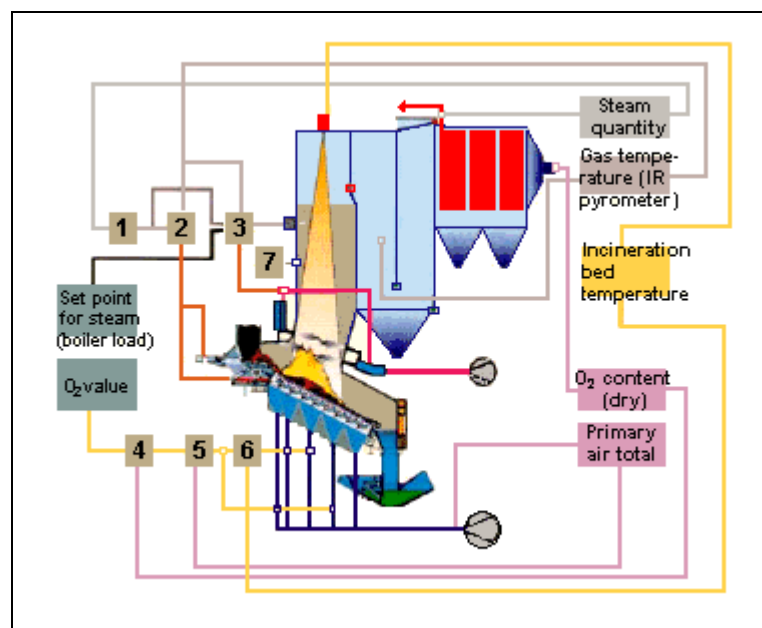

Figure 4.1: An example of the components of furnace control system [1, UBA, 2001]

By computer controlled image processing, the video images provided by the IR camera can be transformed into signals which are coupled, in the furnace control system, with parameters such as oxygen content in the flue-gas and steam quantity.

The charging of the incineration chamber can then be controlled by recording the average temperature of the waste bed at the foremost part of the grate and evaluation of the O<sub>2</sub> value at the end of the boiler. With the help of camera-controlled incineration bed temperature recording over the first three grate zones, primary air can be added according to demand (air quantity and distribution), which helps to even out the incineration process in the main incineration zone. In grate zone 2 (ignition zone), the air demand is controlled, as a function of incineration bed surface temperature and a more constant temperature profile may be reached. Adapting the air quantity in grate zones 3 and 4, and the temperature of the incineration surface leads to steady incineration and efficient bottom ash burnout.

In a project, incineration tests were run with oxygen conditioned primary and secondary air and additions of nitrogen in the secondary air. A favourable influence on dust, CO and the total VOC concentrations in the flue-gas behind the steam generator was recorded, in particular with oxygenated primary air (O<sub>2</sub> content of supplied enriched air between 25 and 28 % by volume). Moreover, the NO<sub>x</sub> content in the flue-gas could be reduced due to the addition of nitrogen to secondary air.

The results from this investigation have led to the development of a system combining the following process steps:

- fully automatic incineration control through infrared camera and fuzzy logic
- flue-gas recirculation to the furnace via a secondary air system, and
- oxygenation of the primary incineration air in the main incineration zones.

Measures introduced at another existing plant with feed grate included:

- graded addition of incineration air
- constant dosing of waste through height of layer control
- incineration monitoring by optic sensors (so-called incineration sensors) in different grate zones
- flue-gas re-circulation.

Compared to the plant's conventional operation, the combustion related pollutants were reduced.

### **Achieved environmental benefits**

Improved overall combustion performance and reduced emissions to all media.

### **Cross-media effects**

No cross-media effects identified in respect of the use of infrared cameras.

Use of oxygen and energy for its generation – where applied.

### **Operational data**

The results from the tests with normal operation and with incineration control with the IR camera and with oxygen addition are shown in Table 4.11 below:

Flue-gas component (crude flue-gas behind steam generator)	Normal operation	IR camera plus fuzzy logic	O <sub>2</sub> conditioning
Oxygen content (Vol.-%)	9.1 – 9.3	8.9 – 9.3	6.2 – 10.9
Carbon monoxide mg/m <sup>3</sup> )	12 – 32	9 – 26	20 – 27
Dust (g/m <sup>3</sup> )	0.7 – 1.7	0.6 – 1.0	0.5 – 1.0
Total carbon mg/m <sup>3</sup> )	1.1. – 2.4	0.9 – 1.0	1.0 – 1.2
Dioxins/furans (ng I-TE/m <sup>3</sup> )	1.5 – 2.7	1.0 – 1.3	2.0 – 3.5
TWG comment: The increase in PCDD/F with additional oxygen shown here, is not the theoretically expected result.			

**Table 4.11: Crude flue-gas measurements at a test plant under normal operation, with IR camera and O<sub>2</sub> conditioning**  
[1, UBA, 2001]

### Applicability

Mainly applicable to grate incinerators. This technique is applicable only if can be applied when the furnace design (in particular the throat) is such that the camera can view the relevant areas of the grate. Moreover, the application is limited to and in general with larger scale furnaces, with several grate lines (e.g. >10 t/h). [74, TWGComments, 2004]

### Economics

The order of magnitude for one camera (not installed and as a stand-alone unit, i.e. not integrated in the control circuit of the plant) is reported at approx. EUR 50000. However it is also reported that one supplier quotes EUR 300000 per line (information provided is not clear if this relates to the whole system of IR plus O<sub>2</sub> control etc) [74, TWGComments, 2004]

### Driving force for implementation

Improved combustion performance results in overall improvements in environmental performance.

### Example plants

Coburg, Germany.  
Ingolstadt, Fribourg, Brescia, Arnoldstein and others.

### Reference literature

[1, UBA, 2001], [64, TWGComments, 2003]

## 4.2.8 Optimisation of air supply stoichiometry

### Description

In combustion systems, sufficient oxygen (usually from air) must be supplied to ensure that the combustion reactions go to completion.

In addition to this, the supply of air has the following roles:

- cooling
- avoidance of slag formation in the combustion chamber/boiler
- mixing of gases to improve efficiency
- influencing burnout quality.

Supplying too little, or too much air, causes difficulties. The precise amount of air required is dependent upon:

- waste type and characteristics (CV, moisture, heterogeneity)
- type of combustor (fluidised beds have lower overall air requirements due to increased waste agitation, which increases exposure of the waste to the air)
- ensuring the air is supplied in the correct locations and quantities.

In general, the over-supply of air should be avoided, but importantly, it must still be sufficient to ensure effective combustion (as demonstrated by low and stable CO concentrations downstream of the furnace). The over supply of air will result in increased flue-gas volumes and hence the increased size and associated costs of flue-gas treatment systems.

### **Achieved environmental benefits**

Reduction of flue-gas volumes (and hence treatment requirements) whilst achieving effective gas burnout are the aim of the optimisation.

### **Cross-media effects**

No information supplied.

### **Operational data**

No information supplied.

### **Applicability**

No information supplied.

### **Economics**

No information supplied.

### **Driving force for implementation**

Optimisation of the incineration process

### **Example plants**

Most of waste incineration plants in EU

### **Reference literature**

[64, TWGComments, 2003]

## **4.2.9 Primary air supply optimisation and distribution**

### **Description**

Primary air is that which is supplied into, or directly above, the waste bed to provide the oxygen necessary for the combustion. Primary air also helps drying, gasifying and cooling some of the combustion equipments.

The manner of primary air supply is directly related to the incineration technology.

In grate systems it is supplied through the grate into the waste bed to:

- bring the necessary air to the different zones of the grate where the reactions occur (drying, gasification, volatilisation) and ensure homogeneous and sufficient distribution inside the waste bed which improves bottom ash burnout
- cooling of the grate bars to prevent slagging and corrosion. The cooling of fluid-cooled grates is typically achieved by means of a separate water circuit and the effect of the primary air on cooling is therefore irrelevant.  
[74, TWGComments, 2004]

In MSWI grates, the primary airflow is determined primarily by the oxygen requirement (a sizing function) and not by the grate cooling requirements. [74, TWGComments, 2004]

In rotary kilns, stepped and static hearths, the primary air is generally introduced above the waste bed. In some stepped hearth designs primary air can be partially introduced below the waste bed.

In fluidised bed systems the primary air is introduced directly into the fluidisation material and also serves to fluidise the bed itself. The primary air is blown through nozzles from the bottom of the combustion chamber into the bed.

The balance of primary and secondary air will depend upon the waste characteristics and upon which of the combustion technologies is utilised. Optimisation of this balance is beneficial for process operation and emissions. In general, higher calorific value wastes allow lower primary air ratios.

Separating the supply of the primary air (using individual wind boxes and, if suitable, multiple or distributed supply fans) to the different zones within a grate incinerator, allows the separate control of the air supply to each of the zones. This allows each process that occurs on the grate (drying/pyrolysing/gasification/volatilisation/ashing out) to be optimised by provision of its own optimised air supply.

Insufficient supply of primary air to the final (ashing out) stage can result in poor ash burnout if residence time in the chamber is not high enough.

If the combustion air is extracted from waste storage areas this will help to reduce odour risks from waste storage.

#### **Achieved environmental benefits**

Optimisation of air supply and distribution is beneficial for the optimisation of the combustion stage of the incineration process and for reducing overall emissions.

Improved burnout of bottom ash.

Reduced demand of primary fuels for the support of combustion. [74, TWGComments, 2004]

#### **Cross-media effects**

No significant effects

#### **Operational data**

Easily installed. Primary air supply is essential for combustion process. Its optimisation differs with the combustion technique.

#### **Applicability**

Applied at every plant

#### **Economics**

Provided the initial design is correct and provides systems and equipment for primary air control, additional equipment and costs are not normally incurred. Where intervention is required at an existing plant, additional fans and ducting may be required to control and distribute the air supply.

#### **Driving force for implementation**

Where improved combustion and reduced emissions to all media, and in particular where improved burn-out of bottom ash are drivers.

#### **Example plants**

All the incineration plants.

#### **Reference literature**

[64, TWGComments, 2003]

## 4.2.10 Preheating of primary and secondary air

### Description

Heating the primary air supply can improve the combustion process by drying the waste. This is especially important where low LCV/high moisture wastes are burned as they may require additional drying. [2, infomil, 2002, 64, TWGComments, 2003]

Heating the secondary air supply can improve the efficiency and assist the combustion process in case of low LCV wastes by ensuring that temperatures in the gas burnout zone are adequate and evenly distributed.

Preheating of incineration air in grate municipal waste incineration plants is normally done with low pressure steam and not by heat exchange from the flue-gases (complicated air ducts, corrosion problems).

Preheating of air for bubbling fluidised bed incineration is normally done with flue-gas by means of heat exchange, but sometimes also with steam or supporting fuel. [64, TWGComments, 2003]

In some installations this heat is taken from the cooling air behind the refractory material.

The heat supplied with the air supply is not lost since it may be recovered later in the boiler. [74, TWGComments, 2004]

### Achieved environmental benefits

More stable combustion leads to lower emissions to air.

Upgrading of flow value steam/energy to better quality steam is possible.

### Cross-media effects

Where heat is taken from the incineration process the cross-media effects will be minimal. If external fuel sources are used the consumption of that external energy and the additional emissions (e.g. of NO<sub>x</sub>, particulates) are a factor.

### Operational data

Primary air is heated to 150 °C by mixing primary air with cooling air of refractory material in the furnace. [74, TWGComments, 2004]

### Applicability

The heating of primary and possibly secondary air is of particular benefit where low calorific value wastes are burned. In the case of primary air, this is because it supports the drying and ignition of the waste, with secondary air this is because it helps to maintain temperatures in the gas burnout zone.

Plants burning high calorific value waste need the cooling effect of the air supply and will not, therefore, benefit from this technique.

### Economics

The design of the system for new plants adds the cost of a heat exchanger plus steam/condensate circuit. The impact of the additional cost depends on the plant scale.

Retrofitting at existing plants will require specific additional investment.

Capital costs of heat-exchange equipment can be offset against the avoided cost of external fuels.

### Driving force for implementation

Improved combustion performance, especially where low LHV wastes are encountered.



**Example plants**

Applied to plants throughout Europe.

**Reference literature**

[2, infomil, 2002], [64, TWGComments, 2003]

**4.2.11 Secondary air injection, optimisation and distribution****Description**

During drying, gasifying, incineration, and burnout, the combustible waste materials are transformed into a gaseous form. These gases are a mixture of many volatile components, which must be further oxidised. For this purpose, additional air (so-called secondary air) is introduced into the furnace.

The incineration temperature can be raised by preheating the incineration air, and lowered by allowing in more incineration air (note: sufficient gas residence time mainly depends on the dimensions of the furnace). Therefore, in some cases the secondary air may provide cooling as well.

Another main function of the secondary air is to mix the hot flue-gases, for this purpose it is blown into the furnace through a large number of nozzles, which ensures that the furnace's entire cross-section is sufficiently covered. Because the mixing of hot gases requires sufficient mixing energy, the secondary air is blown in at relatively high speed. Additionally, dimensions of the furnace are selected to ensure adequate flue-gas flow patterns and sufficient overall residence times. For MSWI the flowrate is determined by the mixing requirements.

The injection port locations, directions and quantities can be studied and optimised for various furnace geometries, using for example computerised flow modelling.

Temperatures at the nozzle heads can contribute significantly to NO<sub>x</sub> production. Typical temperatures are in the range of 1300 to 1400 °C. The use of special design nozzles and of FGR to replace some of the nitrogen can reduce nozzle temperatures and nitrogen supply that lead to higher NO<sub>x</sub> production.

**Achieved environmental benefits**

- low and stable emission of combustion related substances
- improved oxidation of combustion gases produced during earlier combustion stages
- reduced carry over of products of incomplete combustion and fly ash to gas cleaning stages.

The benefits are to reduce the quantity of combustion related substances (e.g. NO<sub>x</sub>, CO and/or VOC). CO and VOC levels are not treated in the FGT.

**Cross-media effects**

If secondary air with normal oxygen content is injected into the afterburning zone, on top of the nozzles while entering the afterburning zone, temperatures above 1400 °C can be measured and by this thermal NO<sub>x</sub> is produced. [74, TWGComments, 2004]

**Operational data**

The amount of secondary air depends on the LCV. [74, TWGComments, 2004]

For grate technology, the amount of secondary air is normally between 20 and 40 % of the total amount of incineration air, with the remainder being primary air.

There is a risk of rapid corrosion of the water walls of the post combustion chamber and the boiler, if secondary air is too low, as the CO/CO<sub>2</sub> level could pulse between oxidising and reducing conditions.

### **Applicability**

All waste incineration plants.

### **Economics**

The costs of making changes to optimise secondary air at individual existing plants will vary greatly according to specific design features. This cost is included in the design of the process of new plants. [74, TWGComments, 2004]

If the NO<sub>x</sub> level is reduced, it may also reduce the cost of the corresponding treatment, and improve NO<sub>x</sub> achievable level of abatement concerning SNCR technique. The secondary air optimisation might reduce the flue-gas volume and therefore reduce correspondingly the FGT plant size. However the mass flowrate of the pollutants remains similar. [64, TWGComments, 2003]

### **Driving force for implementation**

Improvements at the combustion stage result in reductions in emissions to all media.

### **Example plants**

Employed at the design stage of the majority of new plants.

An examples of retrofit to improve this aspect are: Toulon (F), lines 1 & 2 (2 x 12 t/h), when fans and injection nozzles were changed.

### **Reference literature**

[2, infomil, 2002] [64, TWGComments, 2003]

## **4.2.12 Replacement of part of the secondary air with re-circulated flue-gas**

### **Description**

One of the purposes of the secondary air addition (apart from oxidising the combustible species in the flue-gas), is to improve the mixing and homogeneity of flue-gas. However, the use of more secondary air than is necessary results in higher flue-gas quantities. This reduces the energy efficiency of the plant, leading to larger flue-gas treatment units and, therefore, to higher costs.

By replacing part of the secondary air with re-circulated flue-gases the flue-gas volume is reduced downstream of the extraction point and at the point of emission. The reductions in the fresh nitrogen supply (from air) to the furnace may help to reduce NO<sub>x</sub> emissions.

In general the re-circulation extraction point is after FGT to reduce corrosion and other operational problems caused by raw flue-gas, this involves some energy losses and FGT system must be designed for a larger flow.

However, if the flue-gases are re-circulated from upstream of the FGT system then the size of the FGT system can be reduced, [64, TWGComments, 2003] although it needs to be set to treat more polluted flue-gases because of the increased concentration and there is higher risk of erosion, corrosion and fouling. [74, TWGComments, 2004]

See also Section 4.2.11 on secondary air optimisation.

### Achieved environmental benefits

- reduced flue-gas volumes and hence FGT treatment size of the FGT downstream of the flue-gas extraction point (i.e. generally where dirty gas is re-circulated)
- improved energy efficiency (approx. 0.75 % increases reported at a CHP plant)
- reduction in NO<sub>x</sub> production by 10 % up to 30 % (if high NO<sub>x</sub> levels exist in the raw gas)
- reduction in reagent consumption for NO<sub>x</sub> control.

At high excess air rates, approximately 50 % of the required amount of secondary air can be replaced by re-circulating flue-gases. When the recirculated gas is raw flue-gas, this results in a 10 – 15 % reduction of the total amount of incineration air and flue-gases. The load of the flue-gas treatment system may be reduced proportionally if the concentrated pollutants in the reduced flue-gas quantity can be cleaned in the same way (resulting also in a reduction of emission loads) and the thermal efficiency of the plant may increase by approximately 1– 3 %.

### Cross-media effects

Depending on precise furnace design, at high replacement rates the effective reduction of oxygen can result in elevated CO (and other PICs) levels. Care must, therefore, be taken to ensure replacement rates are optimised.

There may be a negative cooling effect in the rotary kiln, in some cases, especially with lower CV wastes, extra fuel is necessary to maintain the rotary kiln temperature.

### Operational data

Corrosion in the re-circulation ducting has been reported. It is also reported that this can be overcome by the elimination of joints, and using effective insulation of ducting to prevent cold spots, where condensation of the flue-gas and corrosion can rapidly occur. Corrosion may also occur in the boiler due to lower oxygen levels in the flue-gas.

[21, FNADE, 2002] If the operator is not attentive, corrosion can be very rapid. In such cases the expected operational savings are quickly turned into higher repair costs and plant availability loss. Corrosion risk is reduced if the hotter parts of the boiler are covered by special claddings. However, when this cladding is installed, the O<sub>2</sub> excess concentration at the boiler exit can be reduced even without FGR. This, then, reduces the benefit of FGR.

In some German MSWI plants with installed recirculated flue-gas systems the recirculation is reported to be closed or out of operation for operational reasons. The reduced flue-gas flow is in most cases is not used in the sizing of the FGT plant; many operators choose to size the FGT plant with flue-gas recirculation OFF, so as to cover all possible operating conditions.

[74, TWGComments, 2004]

### Applicability

This technique has been applied to new waste incineration plants. Some existing plants have retrofitted this technique, for which space is required for the ducting.

The technique has a limited applicability for HWI. In the case of rotary kilns HWI there is a need of high O<sub>2</sub> content and therefore the recirculation of gas has a limited applicability. [74, TWGComments, 2004]

### Economics

This technique involves additional investments for new plants and significant cost for retrofitting existing plants. [74, TWGComments, 2004]

### Driving force for implementation

Reduction of NO<sub>x</sub> using primary techniques.

Even with FGR, a de-NO<sub>x</sub> device is required for reaching, under any operational condition, a level of 200 mg/Nm<sup>3</sup>. [21, FNADE, 2002]

### Example plants

Applied at some new and existing plants throughout Europe.

### Reference literature

[2, infomil, 2002], [21, FNADE, 2002] [64, TWGComments, 2003]

## 4.2.13 Application of oxygen enriched air

### Description

Replacement of air supply with (technically) pure oxygen or oxygen enriched air.

This technique is applied at some gasification and pyrolysis plants for the combustion of the gases they produce, often as part of systems that are designed to raise combustion temperatures in order to melt the incinerator ashes. In such cases the initial pyrolysis or gasification reactor is often a physically separate unit from the subsequent combustion chamber. The fuel rich syngases pass into the combustion zone, where the oxygen enriched air is added at a controlled rate in order to achieve the desired combustion conditions. Depending on oxygen addition rate and gas quality, temperatures in the combustion chamber are generally between 850 and 1500 °C, although in some specific case temperatures of up to 2000 °C (or higher) are used. At temperatures above around 1250 °C, entrained fly ashes are melted.

This technique has also been applied on a trial basis at existing large incineration plants in order to improve the process performance and as a specific design technology at smaller plants that are generally dedicated to the destruction of particular (often hazardous) waste streams. In these smaller plants (e.g. trailer mountable plants) the process may be applied on a batch basis in a sealed reactor, with elevated pressure (8 bar) and temperatures (e.g. in the range of 2000 to 8000 °C).

### Achieved environmental benefits

Rapid and efficient combustion can result in very low and controllable CO and other combustion related emissions.

Replacement of the nitrogen in air with oxygen can reduce the potential for thermal NO<sub>x</sub> formation. However, NO<sub>x</sub> production also depends on flame temperature so care is required to ensure that nitrogen replacement is sufficient to prevent the combination with higher temperatures from resulting in an overall increase in NO<sub>x</sub>.

A lower volume of waste gas is released compared to air fed combustion technologies. However, at temperatures above 1500 °C this benefit may be reduced owing to expansion of flue-gases. The more concentrated pollutants that result from the lower flue-gas volume can be captured with a compact FG treatment line. However, such an adaptation would require specific adaptations in the flue-gas treatment at existing plants. Reduced FGT size may reduce consumptions to some degree (e.g. for NO<sub>x</sub>), but this is largely related to pollutant load (rather than concentration) and therefore reductions may be negligible for waste contained pollutants. It is reported that the boiler size may also be reduced using this technique.

[74, TWGComments, 2004]

The use of temperatures in excess of 1500 – 2000 °C are reported to have only a limited additional benefit in terms of emissions reduction. [64, TWGComments, 2003]

### Cross-media effects

The production of pure oxygen or oxygen enriched air is energy consuming.

Presence of CO during transitory phases: start-up, shutdown and emergency stops.

Problems of reduced resistance of refractory materials and an increase of corrosion.

**Operational data**

Trials at an existing grate municipal incineration plant in the Netherlands encountered difficulties with locally increased temperatures and corrosion. These difficulties are reported to be overcome with better waste mixing and optimised injection.

At higher temperatures (above 1000 °C) furnace and refractory maintenance is generally greatly increased. The higher temperatures used can cause significant materials selection and use difficulties.

In addition intensive gas cooling is required to reduce flue-gas temperature to a suitable level for FGT.

Molten fly ash requires systems to ensure its removal (e.g. vortex gas flow) so that it does not come into contact with downstream heat exchangers to cause clogging/erosion.

Additional safety risks result from the production, storage and use of oxygen.

**Applicability**

In general, installations require specific design adaptations to incorporate the use of this technique. Attention is required to most details of plant design including particular adaptations to the combustion chamber, heat exchange areas, and sizing of FGT systems. At low levels of oxygen addition the design changes may be more limited, but so too then are the potential advantages of the use of the technique.

The technique may be applicable as a retrofit option at existing plants where:

- combustion related emissions are high or difficult to control and
- air supply volumes are already high.

The high combustion efficiency can make this technique of use for the incineration of materials that are very highly resistant to combustion, e.g. PCBs.

In practice oxygen enrichment is not widely applied owing to the additional costs and cross-media impacts associated with the generation of oxygen, additional operational challenges (e.g. higher temperatures may result leading to molten ash control issues) and the ability of air based techniques to achieve good performance levels.

**Economics**

Pure oxygen is costly, oxygen enriched air is less expensive but still gives rise to additional costs over normal air. The costs of both may be reduced if the incinerator is on a site where oxygen is already available e.g. some industrial sites. Parasitic electrical loads for on-site oxygen generation are significant. This demand varies according to plant size, temperature and oxygen purity requirements but is generally in the order of 0.5 – 2 MW electrical.

The use of this technique may add significantly to capital and operational costs.

Reductions in the flue-gas volume may reduce the size of flue-gas treatment devices required.

**Driving force for implementation**

The technique has been reported to be used for the treatment of some types of hazardous wastes that are otherwise expensive to dispose of.

The technique is reported to have been used as a retrofit at existing plants that have combustion performance difficulties.

### **Example plants**

In Austria a municipal waste incineration plant has been commissioned at the beginning of 2004 where oxygen enriched air is applied. Annual throughput is about 80000 t/yr, average oxygen content is about 26 %, temperature on the grate is about 1100 - 1200 °C whereas the temperature in the combustion chamber is reduced by means of flue-gas recirculation. No problems have been reported by the operator until now. [74, TWGComments, 2004]

Oxygen enrichment is applied at gasification and pyrolysis processes for municipal and industrial wastes in Japan as part of systems that are designed to melt the incinerator ashes (e.g. Asahi Clean Centre, Kawaguchi City, Tokyo).

The first full-scale unit for HW is now operating at SEABO (Municipality of Bologna). So far it has been used for treating materials such as: hardened paints, halogenated solvents, inks, refinery sludge, plastic packaging, polluted rags, oil containing PCBs, pesticides, expired medicines, among others.

### **Reference literature**

[18, italy, 2002], [2, infomil, 2002], [64, TWGComments, 2003]

## **4.2.14 Cooling of grates**

### **Description**

[19, Babcock, 2002] [64, TWGComments, 2003]

Grate cooling is carried out to control metal temperatures and thereby improve grate life. The cooling medium can be air or water (other liquids may also be used, such as oils or other heat conducting fluid).

Air is supplied below the grate and passes through the grate spacings; the main function of this air is to provide the necessary oxygen for oxidation, and the flowrate is designed according to this requirement. Simultaneously, this air provides cooling to the grates, which is the source of cooling for air-cooled grates. When more excess air is introduced additional cooling is supplied, but a larger amount of flue-gas is produced.

Liquid-cooled grates include a circuit inside the grate by which the liquid is flowing for cooling the grate. The higher heat transfer capacity of liquids make liquid cooled grates more suitable for situations where the cooling with air has limitations, in particular when burning high NCV wastes (e.g. >10 MJ/kg).

The liquid flows from the cool parts of the grate to the hotter ones in order to maintain a temperature differential. The temperature of the liquid can be used to monitor the reactions (some are endothermic, some exothermic, and to differing degrees) occurring in the waste bed above the grate. These reactions can then be controlled by varying the amount of air supplied through that section of the grate to the waste above. This separation of the cooling and air supply functions may increase the control of the process.

### **Achieved environmental benefits**

Both air and water cooled grates can provide for effective waste burnt out.

For higher LCV wastes, using liquid cooled grates can allow slightly increased combustion process control, as the additional cooling capacity required with such wastes can be obtained from the cooling liquid instead of supplying more air so it is, therefore, possible to reduce the primary air supply and hence the overall flue-gas volumes.

### **Cross-media effects**

No significant negative effects identified.

**Operational data**

Air-cooled grates are very widely used and proven for municipal wastes, and for a range of other mainly solid wastes. They are reported to be highly reliable and provide for effective performance and long operational use. Complexity of the air-cooled systems is somewhat lower than liquid cooled systems and this can have operational benefits. The use of air-cooled grates in Europe is very common, with approximately 90 % of incinerated MSW being treated in plants using air-cooled grates.

The liquid-cooled grate system increases grate cooling efficiency as the liquid circulates directly inside the grate. Heat damage may be reduced, and even with the waste high in calorific value, it is possible to achieve a service life of over four years. Effective liquid-cooled grate bar fabrication is required to prevent problems of cracking and liquid leakage, and subsequent effect on installation availability. In order to increase grate temperature control, a sophisticated liquid circuit is required if all the grate bars are to be fed individually with liquid. An alternative is for zones of the whole grate system to be controlled.

In the higher temperature conditions that may arise when incinerating high heat value wastes, the liquid cooled grates can have longer life due to the reduced corrosion they experience but they may have a higher risk of grate damage through leaks of the cooling liquid than with air-cooled systems.

Operational experience has shown that, with water cooled grates, virtually all the leaks occur at the connections between the tiles or the connection between the tiles and the cooling circuit collectors. Hence, the risk on cooling circuit failures can be minimised by reducing the number of these connections. Fluid-cooled grate designs with a low number of connections are preferred. Lifetime of a water-cooled grate tile may be in excess of 35000 – 40000 operational hours.

**Applicability**

A specific feature of grates is that they are highly robust in nature and may be applied to almost any mainly solid waste type, including highly heterogeneous wastes. Both liquid and air-cooled grates are applied for municipal wastes, with approximately 90 % of MSWI using the air-cooled type.

In general liquid cooled grates are applied where there is a specific need for additional grate cooling i.e. where waste LCV is higher (e.g. above ~10 - 13 MJ/kg, depending on the grate type) Air-cooled systems may also be used in such circumstances, sometimes with other cooling features e.g. water walled furnaces.

**Economics**

Air-cooled grates are more economic to purchase than liquid cooled grates.

Risk of damage to the grate, and hence high repair costs and downtime, may be higher with non-air-cooled systems as liquid leaks may cause damage (but see also Operational Data above).

**Driving force for implementation**

Selection of grate cooling systems is generally made on the balance of operational advantages and disadvantages depending on the heat value and composition of the waste that will be treated. Depending on the particular circumstances (i.e. notably the grate and waste type) it may be possible to treat higher calorific value wastes with a fluid cooled grate than with an the same air-cooled grate.

**Example plants**

Cooling of grates is widely used in Europe and worldwide. Water cooled systems are less widely used but are reported to be applied at least in Denmark and Germany.

**Reference literature**

[19, Babcock, 2002], [64, TWGComments, 2003]

### 4.2.15 Water cooling of rotary kilns

#### Description

[20, EKOKEM, 2002]

This technique is usually used together with higher temperatures in the kiln (see Section 4.2.16). The rotary kiln cooling system consists of two cooling circuits. The primary cooling water circuit delivers primary cooling water on top of the rotary kiln and distributes it evenly to guarantee equal cooling effect all over the shell of the kiln. Water is then collected into four water collection basins located under the kiln and it continues to flow freely into the water collection tank. Water is circulated back through a filter and a heat-exchanger with a circulation pump. Evaporation is compensated with additional make-up water, which is automatically buffered with NaOH in order to avoid corrosion.

The secondary circuit removes heat from the primary circuit through heat-exchangers and transfers it for use. If there is no need for energy recovery, a multi-sectional air cooling system can be used for removing heat from the system. In order to avoid freezing, a water-glycol mixture is circulated through the liquid-air heat-exchangers.

The system delivers cooling water through hundreds of spray nozzles situated all over the shell of the kiln keeping the temperature of the shell at 80 – 100 °C, whereas, for air cooling the steel shell temperature is typically a few hundred degrees higher. The rotary kiln cooling increases the heat transfer through the refractory enough to reduce the rate of chemical erosion to minimum. Higher temperatures can be used in the kiln.

#### Achieved environmental benefits

The main benefit of rotary kiln water cooling is that higher combustion temperatures may be used where required (see advantages in Section 4.2.16).

The heat transfer rate through the furnace into the primary cooling fluid is increased. According to theoretical calculations and practical measurements at example installations, the heat transfer through the furnace into the cooling water varies between 0.5 MW and 3.0 MW, depending on the size of the rotary kiln and the thickness of the refractory. The thickness of the refractory includes the remaining brick lining and the solidified bottom ash layer. For example, in 1995 Kommunikemi (DK) reported an average kiln heat recovery of 2.2 MW.

#### Cross-media effects

No negative aspects identified.

#### Operational data

Operational benefits are:

- extended refractory lifetime when operating at higher temperatures - lower maintenance
- increased throughput rates possible - especially for higher calorific value wastes
- better working environment - lower temperatures beside the kiln.

#### Applicability

This technique is applicable to rotary kiln incinerators with higher LHV inputs. It is mainly applied at hazardous waste plants but could also have wider applications to other waste burned in rotary kilns. The technique is especially suited to plants that require high temperatures for the destruction of particular types of wastes.

Water cooled kilns are reported to mainly offer extended refractory life for wastes with low melting mineral matter.

Where the system is combined with a high temperature kiln, water flowrates must be high to achieve sufficient heat removal rates. This will result in a larger quantity of warm water, rather than a lower quantity of hotter water. The technique is, therefore, more likely to be applicable to processes that have a demand/use for the warmed water generated.



**Economics**

Both Ekokem in Finland and Kommunekemi in Denmark, have reported a capacity of over 100000 tonnes of incinerated hazardous waste (waste water not included) at high temperatures with the same brick lining. This equals an overall lifetime of two to three years. Both plants typically shut down the waste incineration once a year for a planned two-week pre-maintenance period and only twice a year for shorter inspections.

**Driving force for implementation**

Some operators have been required to operate high temperature slagging kilns and have, therefore, developed the water cooling system to allow economic operation in such circumstances. Where non-disposal outlets (e.g. re-cycling as aggregate replacement) exist for the semi-vitrified bottom ashes produced, this may reduce disposal costs and hence increase interest, or offset costs of the technique.

Availability of a customer for the warmed cooling water increases interest in this technique.

Availability of higher LHV wastes (e.g. solvents and oils) allows high operation temperatures which then require the additional cooling noted here. Where such wastes are diverted to other waste treatment options, their availability may be restricted and operation in higher temperature mode only possible with additional fuels/costs.

**Example plants**

Ekokem, Finland. Kommunekemi, Denmark

**Reference literature**

[20, EKOKEM, 2002], [40, EURITS, 2003] [64, TWGComments, 2003]

**4.2.16 Higher temperature incineration (slagging)****Description**

This technique is most commonly applied in Europe to rotary kilns treating hazardous wastes. However, the principle of operating at elevated temperatures can, to some degree, be applied to other furnace types. For example, higher temperatures are sometimes used downstream of fluidised beds receiving non-hazardous wastes (see Section 4.2.26 and 4.2.27).

Hazardous wastes, both solid and liquid, are fed into the process through the front wall of a rotary kiln. Only secondary air and waste water are injected into the secondary combustion chamber.

The incineration temperature rises to 1100 – 1400 °C for a couple of seconds, as all the high calorific wastes are introduced through the front wall of the kiln. This means that the temperature of the flue-gases stay over 1050 °C until they pass from the outlet of the secondary combustion chamber. Next, they enter the waste heat boiler and finally flow through the flue-gas cleaning system.

**Achieved environmental benefits**

High temperature incineration at 1100 – 1400 °C has been reported to provide the following advantages compared to lower temperature (850 – 900 °C) combustion:

- all organic materials are completely incinerated. Organic matter content in bottom ash after incineration is typically less than 1 %
- lower contents of hydrocarbons and CO in flue-gases
- higher destruction of PCB molecules
- a molten bottom ash is formed in the rotary kiln.

The slag, when quenched in water, becomes finely granulated, vitrified and has low leaching characteristics. It may be recovered or transported to landfill.

Iron, glass, aluminium and other inorganic solid materials form a molten bottom ash mixture in the rotary kiln when high temperature incineration is applied. This liquefied ash then flows slowly towards the outlet of the kiln where it falls down into a bottom ash quenching basin, positioned under the secondary combustion chamber. Here, the bottom ash is quickly solidified in the water and it becomes finely granulated and vitrified. Due to the granulation effect, the total volume of bottom ash produced is smaller than with conventional incineration.

Depending on the leaching tests or other local standards applied, the bottom ash produced in high temperature incineration may be classified as non hazardous material. This may then reduce the cost of disposal, since the bottom ash may then be transported to a regular landfill (under certain conditions), or even sold for utilisation in road construction. If used for construction, the total content of heavy metals may need to be low, and impact may be judged by comparison with that of other material used normally for that purpose. [74, TWGComments, 2004]

### **Cross-media effects**

Higher temperatures can result in additional NO<sub>x</sub> formation and a requirement for additional control measures.

If the LHV of the waste itself is insufficient, additional fuels may be required.

Adapted gas cleaning may be needed to deal with the higher levels of heavy metals vaporised. [40, EURITS, 2003]

### **Operational data**

Higher temperatures require a good quality refractory lining. Additionally a constant slag layer should be managed during the operation.

In addition:

- incineration air may require preheating
- the amount of incineration air needs reducing
- membrane boiler walls need removal or protection with refractory
- high temperature corrosion may be a problem
- molten slag may cause operational problems in the furnace and heat exchange areas.

Low residual hydrocarbons and CO is dependent on the combination of flue-gas mixing (turbulence), residence time and temperature. Temperatures of 900 - 1000 °C have been reported to achieve very high destruction levels, similar to those achieved at the higher temperatures considered here. Homogeneous waste feeding is also considered an important influence. Hence, very high temperatures alone are not a guarantee for high gas burnout (i.e. low CO and VOC). Also, at higher temperatures the gas velocity is higher, thus the residence time lower - therefore the overall combination of parameters is important.

### **Applicability**

Mainly applicable to rotary kilns burning hazardous wastes of higher calorific values e.g. those that include various solvents and waste oils.

**Economics**

Additional costs arise from:

- the need to use a water cooled kiln in order to avoid high maintenance costs
- support fuels may be needed to maintain high temperatures
- modifications to furnace may be required to retain heat
- addition of inorganic materials (glass, sand), producing more bottom ash
- scrubbing of heavy metals which evaporate more at higher temperatures.

[74, TWGComments, 2004]

In some cases the use of higher temperatures has been abandoned on account of costs associated with refractory maintenance.

**Driving force for implementation**

The technique has been implemented where:

- additional assurance of very high destruction efficiencies are required
- vitrified bottom ash residues are required.

Mainly employed at plants where the calorific content of the wastes are sufficiently high (overall average typically above 15 MJ/kg) to avoid the need for support fuels.

**Example plants**

Ekokem, Finland. Kommunikemi, Denmark

**Reference literature**

[20, EKOKEM, 2002] [64, TWGComments, 2003]

**4.2.17 Increased agitation and residence time of the waste in the furnace****Description**

Waste fed to the furnace needs to be well mixed and allowed sufficient time to react and ensure that effective burnout is achieved, thereby leaving a residue that is low in organic carbon. In addition, the supply of adequate and well distributed primary air, which does not result in excessive cooling, will assist this process.

Longer exposure of the waste to elevated temperatures in the combustion chamber, higher bed temperatures and physical agitation of the waste all combine to ensure that ashes produced are low in organic species.

Burnout rates may, therefore, be improved by:

- furnaces that turn and agitate the waste effectively
- use of rotary kilns
- pretreating waste and then using fluidised beds (where the waste is suited to this technology)
- longer residence times in the furnace burnout zones
- design of furnace to reflect radiant heat and increase burnout
- optimising primary air distribution and supply
- addition of other wastes/fuels to support effective combustion
- disintegration of bigger pieces of waste
- sifting (riddling) return for repeated incineration.

The use of these techniques can result in organic-carbon-in-ash levels of below 1 %.

The level of burnout achievable using any technique will depend upon the characteristics of the waste being incinerated. Waste physical characteristics will also have a critical influence on the practicality of feeding the waste type to the different designs of combustor, e.g. mixed municipal waste cannot be treated in a fluidised bed without pretreatment.

Typically, better burnout will be achieved where waste is finely divided and has been homogenised (e.g. by mixing). The pretreatment of highly heterogeneous wastes can improve burnout.

### **Achieved environmental benefits**

Effective burnout of the waste results in:

- effective waste destruction
- improved characteristics of the solid residue for possible use
- increased extraction of the energetic value from the waste.

### **Cross-media effects**

Excessive physical agitation of the waste can result in higher quantities of unburned material being carried into the secondary combustion chambers. This can result in additional dust and other pollutant loading on downstream abatement processes. Additionally, excessive agitation CAN result in more riddlings, i.e. unburnt material passing through the grate. [74, TWGComments, 2004]

### **Operational data**

It should be noted that, while some technologies may incorporate greater agitation to result in better burnout and hence lower unburned matter in the residues produced, they are not generally chosen specifically for these reasons, but primarily for their mechanical suitability to the physical characteristics of the waste received i.e. the waste homogeneity etc. [64, TWGComments, 2003]

The level reported to be achieved in Austrian incineration plants for a stable process is 1 % TOC (dry substance) and about 3 % TOC (dry substance) for start and shutdown.

### **Applicability**

The nature of the waste received may restrict the actual combustion technology selection (i.e. fluidised bed or grate, etc) and hence restrict the operators ability to select between technology options. However, the principles of increased agitation and of holding the waste in the furnace for sufficient time at sufficient temperature apply in all cases. Each chosen technology can, therefore, review the options described here that are available to it, to improve burnout.

### **Economics**

New projects can take account of the need to ensure effective burnout without significant additional costs.

Major reconstruction of combustion chambers at existing plants is expensive. Retrofit may therefore, only be possible when complete refit is planned (unless the minimum legal standard of 3 % TOC is not achieved, in which case action is mandatory).

### **Driving force for implementation**

The main driving forces are:

- improving waste destruction
- improving possibilities for residue use
- extraction of full energetic value from the waste.

Article 6 of EC Directive 2000/76/EC requires that slag and bottom ashes have a Total Organic Carbon (TOC) content of less than 3 % or their loss on ignition is less than 5 % of the dry weight of the material.

**Example plants**

Throughout Europe.

**Reference literature**

[4, IAWG, 1997] [64, TWGComments, 2003]

### **4.2.18 Adjustment of throughput to maintain good burnout and combustion conditions**

**Description**

The level of burnout achieved in the bottom ash residues is a parameter to consider when determining the throughput limitations of the process with a particular waste input.

Levels of TOC above 3 % (5 % LOD) are prohibited by European legislation. Levels of below 1 % are achieved in some circumstances (see Section 4.2.17 above).

For a given range of waste characteristics, the thermal capacity of the combustor is the limiting factor rather than the mass throughput. Exceeding the thermal capacity of the plant leads to a deterioration in combustion performance and of the quality of the residues produced.

**Achieved environmental benefits**

Maintaining the process within the thermal throughput capacity of the process ensures wastes are properly destroyed and that the residues produced are of better quality, with improved possibilities of their use.

**Cross-media effects**

Use of the technique avoids cross-media effects.

**Operational data**

Burnout levels may be reduced by increasing waste residence time in the furnace. This then results in a reduction of the throughput rate of the installation.

**Applicability**

Applicable to all waste incineration plants.

**Economics**

Restricting the waste throughput can result in lower income from waste disposal.

**Driving force for implementation**

- ensures full waste destruction
- improving ash quality.

**Example plants**

This is a common practice widely applied in the industry.

**Reference literature**

Discussions during site visits. [64, TWGComments, 2003]

### 4.2.19 Optimisation of time, temperature, turbulence of gases in the combustion zone, and oxygen concentrations

#### Description

To achieve effective combustion of the gases produced during the incineration process, the gas needs to be well mixed with sufficient oxygen, at a high enough temperature and for a long enough time. Based upon these principles and practical experience of industrial scale incineration plants, minimum criteria have been established in various European and National legislation. The aim of these criteria is to ensure processes are designed and operated in such a way that they ensure that the gases produced are oxidised and that organic pollutants are destroyed, so as to reduce polluting emissions of these substances.

Table 4.12 below provides a brief summary of some specifications that have been applied to the combustion of the gases that are produced during the incineration process:

Parameter	Specification	Purpose
Minimum combustion temperature during gas residence time	<ul style="list-style-type: none"> <li>at least 850 °C, or</li> <li>at least 1100 °C for hazardous wastes with greater than 1 % halogenated organic substances (as Cl)</li> </ul>	<ul style="list-style-type: none"> <li>adequate temperatures to allow oxidation</li> </ul>
Minimum gas residence time	<ul style="list-style-type: none"> <li>2 seconds after the last injection of combustion air</li> </ul>	<ul style="list-style-type: none"> <li>sufficient residence time at high enough temperature in the presence of sufficient oxygen to react and oxidise</li> </ul>
Turbulence	<ul style="list-style-type: none"> <li>Sufficient to ensure effective gas mixing and combustion reaction</li> </ul>	<ul style="list-style-type: none"> <li>mixing of gas to allow reactions to proceed across the entire gas stream</li> </ul>
Oxygen concentration (excess)	<ul style="list-style-type: none"> <li>greater than 6 % (note that the precise oxygen requirement was removed in most recent EU legislation)</li> </ul>	<ul style="list-style-type: none"> <li>sufficient oxygen must be supplied to allow oxidation</li> </ul>

**Table 4.12: Some combustion specifications applied to incineration**

Operational experiences have shown that these criteria are generally appropriate and will achieve good levels of destruction. However, many existing plants operate with reduced temperatures, residence times and oxygen concentrations, and still achieve effective combustion and low emissions to all environmental media. Indeed, at some plants, reductions in NO<sub>x</sub> emissions (in particular) have been achieved without significant deterioration of other performance parameters, or corrosion problems.

It is therefore possible, in some circumstances and for some waste types, that departures from these basic criteria to represent the optimal environmental outcome. If such departures are to be permitted the following aspects need to be examined to ensure effective overall performance:

- low and stable CO concentrations in emissions to air (<50 mg/m<sup>3</sup> daily average)
- burnout of bottom ashes of good quality (TOC <3 %)
- benefits outweigh the risks (e.g. NO<sub>x</sub> reduction achieved is significant)
- is the waste (as fed) suitably homogeneous, consistent and quality assured to give confidence that pollutant destruction will be sufficient across the operational spectrum?
- is the level of turbulence in the combustion zone adequate to allow reduced temperatures/residence time?

Residence time is highly dependent upon furnace size, and therefore, there are few options for increasing residence time once a plant has been constructed, unless a major rebuild is conducted, which can result in very significant expenditure. Generally, new plants are designed to assure residence times of two seconds or more except when specific specialist and highly controllable and homogeneous waste streams are burned, thereby allowing an increased certainty of achieving emission levels. [64, TWGComments, 2003]

### Achieved environmental benefits

The potential benefits of reducing the minimum oxygen concentration and the minimum temperature levels are:

- reductions in NO<sub>x</sub> production and hence treatment requirements and/or emissions
- reduced flue-gas volumes, which can result in reduced FGT requirements
- improved energy efficiency.

In general, reducing the gas residence time on its own will not result in any specific environmental benefits but will result from a smaller combustion chamber.

Increasing gas turbulence generally improves mixing and, hence, the oxidation reaction rate that then leads to effective combustion. However, where turbulence is mainly achieved by secondary air injection a balance is required because it is also necessary to avoid excessive air supply which may lead to: excessive cooling or over supply of nitrogen with the air that can increase NO<sub>x</sub> production.

### Cross-media effects

Reductions in time, temperature, oxygen and turbulence can result in increased emissions of PICs if conditions are reduced to such a degree that combustion is not completed. These risks are greater where the wastes (as fed) are highly heterogeneous, of variable composition or where the waste quality is difficult to assure.

N<sub>2</sub>O (nitrous oxide) emission concentrations (and hence global warming impacts) are increased at lower combustion temperatures. CO levels may also be increased at lower temperatures.

The use of higher temperatures than are necessary for the destruction of the type of waste being incinerated, generally results in only small reduction in the quantities of PICs in the untreated raw flue-gas – after gas cleaning the relative benefit will be even smaller. On the other hand, higher temperatures may lead to a significant increase in NO<sub>x</sub> production. Therefore, unless some other specific environmental benefit is sought (e.g. improvement in residue quality using slagging or guaranteed high destruction efficiencies for PCBs) the reduction in some emissions to air achievable through the use of higher temperatures may be outweighed by the cross-media effects of additional fuel consumption, NO<sub>x</sub> production etc. [64, TWGComments, 2003]

#### EXAMPLE: Bubbling fluidised bed burning sewage sludge:

Table 4.13 below shows the relationship found between nitrous oxide emissions and process temperatures at a bubbling fluidised bed plant burning sewage sludge. It should be noted that fluidised bed combustion is very different from grate combustion, and that the nitrous oxide emissions from grate MSWI with a secondary combustion temperature over 900 °C are generally negligible [64, TWGComments, 2003]:

Bed temperature range (°C)	Free board temperature		
	930 °C	910 °C	890 °C
Nitrous Oxide emission			
820 – 845	70	120	200
795 – 820	100	170	270
730 – 795	180	250	350
Data shown are for nitrous oxide concentrations in mg/m <sup>3</sup>			

**Table 4.13: Relationship between nitrous oxide emissions and process temperatures for a bubbling fluidised bed plant burning sewage sludge**  
[22, Mineur, 2002]

### Operational data

There are several different methods for the determination of the time and temperature parameters for a given plant that use different temperature measuring devices located at different positions in boilers with different heat transfer properties: the measurements are conducted with the plant under different percentages of load, and at different times with respect to plant cleaning. These methods have associated levels of accuracy. Despite these uncertainties, modern plants generally show environmental compliance with the EU Directive 2000/76. [64, TWGComments, 2003]

Example: VERA Sewage sludge incinerator, Hamburg, Germany:

Studies were carried out at this fluidised bed plant to demonstrate the impact on emissions of the use of reduced temperature and oxygen in the combustion phase. For fluidised beds both the temperature in the bed and the freeboard are important for effective combustion.

Waste type:	Sewage sludge and screenings
Plant size:	79000 t/yr
Combustor type:	bubbling fluidised bed
Combustion temp (T min)	810° Celsius (in freeboard of combustor)
Oxygen conc. (min)	4 %
Abatement systems:	ESP/HCl and SO <sub>2</sub> scrubbers/fabric filter.

The following data/conclusions were noted from the results at this installation:

- reducing FB temperature from 924 °C to 810 °C did not significantly change PCDD/F emissions (reported figures were a change from 0.0005 ng/m<sup>3</sup> to 0.0008 ng/m<sup>3</sup>)
- reducing oxygen concentration from 6.8 % to 4 % resulted in a reduction of PCDD/F (0.0015 to 0.0005 ng/m<sup>3</sup>)
- at freeboard temperatures below 890 °C NO<sub>x</sub> emissions were between 30 and 40 mg/Nm<sup>3</sup> and independent of changes in bed temperature between 730 °C and 845 °C
- increasing free board temperatures above 890 °C increased NO<sub>x</sub> emissions - the effect was most marked at higher bed temperatures
- at freeboard temperatures below 900 °C, SNCR has little impact on NO<sub>x</sub> emissions
- emissions of N<sub>2</sub>O are higher at lower freeboard and bed temperatures (see data shown in cross-media effects above)
- emissions of N<sub>2</sub>O are almost unaffected by the use of SNCR.

It is reported that lowering oxygen levels can result in increased corrosion rates requiring specific counter measures. [64, TWGComments, 2003]

### Applicability

Mainly applicable at the design stage for new plants and for existing plants undergoing or planning significant retrofitting of the combustion chamber.

Applicable where the available space limits the size of the combustion chamber.

Less applicable where wastes (as fed) are highly heterogeneous, of variable composition or where waste quality is difficult to assure.

Existing plants may already have residence times that are below two seconds. These may be able to justify not carrying out extensive (and expensive) retrofitting by gathering and comparing real performance data concerning the levels of PICs in the raw gas.

### Economics

The estimated cost relevant impacts of changing these combustion parameters, compared to the normal design values, are indicated in the table below:



Parameter	Increase or Decrease in parameter	Estimated cost impact
<b>Combustion temperature</b>	Increase	Additional cost of support fuels increased furnace maintenance costs may reduce ash disposal costs of slagged ash if product saleable
	Decrease	Reduced need for support fuels may restrict waste types that can be burned
<b>Gas residence time</b>	Increase	Larger furnace = higher cost may increase range of wastes accepted changing design of combustor expensive
	Decrease	Smaller process means lower costs may restrict wastes that can be burned
<b>Turbulence</b>	Increase	Changing design of combustor expensive increasing air injection increases flue-gas volumes and FGT costs
	Decrease	Not technically advisable/desirable
<b>Oxygen concentration (excess)</b>	Increase	Higher oxygen excess may allow wider range of waste to be incinerated without emission problems
	Decrease	Reduced flue-gas volumes mean lower FGT costs may restrict wastes that can be burned

**Table 4.14: Estimated cost impacts of some alterations to combustion parameters**

In general the most significant cost issue is for existing plants where the rebuild/retrofit costs of upgrading an existing plant (that is already achieving effective emissions performance) to meet the traditional temperature and residence time requirements, will be very large.

#### **Driving force for implementation**

Reductions in NO<sub>x</sub> production and, hence, a reduction in the measures required to treat flue-gases may be achieved. With very consistent wastes it may be possible to reach NO<sub>x</sub> levels compliant with EC Directive requirements without, or with very minimal need for specific NO<sub>x</sub> controls (e.g. SNCR or SCR).

Lower gas residence times, and flue-gas volumes (reduced by reducing the air supply) mean that smaller combustion chambers and flue-gas treatment plants can be used, resulting in cost reductions.

#### **Example plants**

VERA, Sewage sludge incinerator, Hamburg, Germany

#### **Reference literature**

[22, Mineur, 2002]. Information supplied by UBA during site visit to VERA. [64, TWGComments, 2003]

### **4.2.20 Use of automatically operated auxiliary burners**

#### **Description**

During start-up, auxiliary burners are used to create a zone above the required minimum temperature, through which the flue-gases are fed from the furnace zone to the secondary incineration. This is the predominant operational condition for the burner design.

In order to assure a sufficient temperature under extreme conditions, auxiliary burners are installed. These are used when the temperature falls under the required minimum temperature.

When the plant is shutdown, the auxiliary burners are used when the temperature has fallen below the design limit of the furnace and the temperature sinks below the required minimum temperature. They operate until there is no waste in the incineration chamber.

### **Achieved environmental benefits**

Ensuring that incineration temperatures are adequate by the use of automatically operated burners ensures that the gases produced are properly combusted, reducing raw gas concentrations of PICs at the furnace outlet and hence emissions to all media.

### **Cross-media effects**

Consumption of fuels (usually light oils or natural gas) by the burners.

Auxiliary burners must be optimized for low CO emissions, otherwise high emissions during start-up and shut-down are possible.

### **Operational data**

Start-up without auxiliary burners is possible, but smoother starting with reduced soot and better control of temperature is attained by starting with the burners. Starting without auxiliary burners in normal MSWI plants can increase corrosion risks due to the chlorine content of the waste. [64, TWGComments, 2003]

### **Applicability**

Applicable to all waste incinerators, particularly those receiving wastes of low LHV and/or wastes of inconsistent quality.

### **Economics**

Retrofit costs may be significant owing to difficulties in positioning the burners.

Costs will be significantly higher at processes that operate on a batch basis, although this may be considered to be commensurate with the additional risk of releases that accompanies such operational modes.

### **Driving force for implementation**

Ensuring emissions are reduced to all media and that start-up and shutdown operations are controlled and do not give rise to additional pollutant emissions other than those arising from the burning of gasoil and other fuels.

Legally required by Directive 2000/76/EC, although under certain circumstances this legislation allows for exemptions from the use of a start up burner (2000/76/EC article 6 paragraph 4).

### **Example plants**

Widely used in modern plants throughout Europe.

### **Reference literature**

[1, UBA, 2001] [64, TWGComments, 2003]

## **4.2.21 Reduction of grate riddling rate and/or return of cooled riddlings to the combustion chamber**

### **Description**

In grate incinerators, some of the waste may fall through the grate and be partially combusted. These are called *riddlings*. Attention to grate design, particularly the reduction of spacings between grates, can reduce the effect. The quantity and quality of these riddlings depend on the design of the grate, on the interfaces between the moving pieces together and with the walls and on the mechanism for keeping them tight. [74, TWGComments, 2004]

In order to reduce the passage of riddlings through the grate, the following options are available:

- design and maintain grates such that bar spacings and other factors that may increase riddling passage are reduced
- where riddling rate and type is such that gives rise to ash quality concerns – re-burn in the combustion chamber.

Automatic conveyor systems are used to collect these *riddlings*. The collected material is usually stored for cooling before being re-introduced to the bunker (to avoid fire risk). A proportion of the re-introduced riddlings pass down the grate and are discharged with the bottom ash. They will then have been subjected to the full incineration process and, therefore, be more sterile in nature.

This may be a particular issue where clinical or other wastes with infectivity risks, particularly those that are finely divided in nature, or which contain discreet objects that may fall through the grate (e.g. hypodermic needles) are co-combusted with other wastes.

Riddlings that arise earlier in the passage of the waste through the combustion chamber have a higher risk of retaining infectivity, or having poor burnout and should, therefore, be most closely examined. Riddlings arising at later stages may be well treated and, therefore, less likely to require re-burning.

#### **Achieved environmental benefits**

The main benefits are:

- improved burnout of the waste
- improved ash quality.

The riddling of molten, burning drops of some common plastics (found in MSW) like PE and PET can contribute significantly to total carbon content in ash, to higher COD (Chemical Oxygen Demand) of the bottom ash and to the significant leaching of copper. All of these parameters are improved by the use of this technique. [64, TWGComments, 2003]

#### **Cross-media effects**

Risk of fire when riddlings are in contact with waste.

#### **Operational data**

Storage of the riddlings prior to their re-introduction with the main waste feed is very important to prevent fire risks. Water may be added to ensure that cooling is thorough.

Regular observation to avoid clogging in the collecting areas of riddlings under the grates necessary combined with safety risks to operators and personal [74, TWGComments, 2004]

In France, the regulations set a burnout requirement for bottom ash in MSWIs that incinerate clinical waste of 3 % LOI, which is normally achieved without repeated incineration of riddlings. [74, TWGComments, 2004]

#### **Applicability**

Applicable, in principle, to all grate incinerators, but particularly applicable to those grate incinerators where:

- particular concerns or requirements exist that require improved burnout
- clinical or other infectious wastes are co-combusted that can go through the grate
- grates with larger spacing between grate bars and high riddlings or in other systems where riddling levels may be relatively higher.

### **Economics**

Improving ash burnout quality may reduce disposal costs where the current ash burnout does not meet re-use/disposal requirements without this technique. [74, TWGComments, 2004]

There can be significant investment costs for retrofitting existing plants and extra operational (handling) costs. [74, TWGComments, 2004]

### **Driving force for implementation**

- improved and thorough waste destruction.
- improved bottom ash quality.

The technique is applied at grate incinerators in the Flanders Region of Belgium for the purpose of ensuring burnout and improved ash quality.

### **Example plants**

Indaver GF, Beveren, Belgium.

### **Reference literature**

[64, TWGComments, 2003]

## **4.2.22 Protection of furnace membrane walls and boiler first pass with refractory or other materials**

### **Description**

[2, infomil, 2002] The furnace is formed by membrane walls (also called “water walls”), consisting of rows of vertical tubes, connected by strips, welded together in order to form a closed (membrane) wall, which are part of the boiler's evaporation section. In the lower section of the furnace especially, the membrane walls must be protected against the corrosive and abrasive effect of the flue-gases, which are not yet fully incinerated at that position. For this purpose, the furnace walls of the lower section are covered with a layer of ceramic refractory material or other protective materials. An additional advantage of this wall protection for lower calorific value wastes, is the reduction of the heat transfer to the boiler, which is beneficial where temperatures need to be maintained.

In most modern waste incineration plants, the whole boiler, except the economiser, is made of water tube walls. In steam boilers, these tubes are a part of the vaporiser.

When there are no water walls, cooling is sometimes made by air circulating behind the refractory plates, often the warmed air is then used for primary air heating.

The role of the refractory is to reduce the heat transfer and to protect the tubes from excessive heat and corrosion. It is installed inside the furnace/boiler; on the outside of the furnace/boiler there is thermal insulation material. [74, TWGComments, 2004]

With high LCV waste, combustion temperatures are normally reached without problems. The main purposes of the ceramic refractory layer are, therefore, the protection of the furnace walls against high temperature corrosion and to prevent the temperature from decreasing too quickly. With higher steam conditions and a higher LCV waste, a larger part of the furnace walls needs to be covered with ceramic refractory material. An alternative solution is the use of specific anti-corrosive alloy claddings, such as Nickel/Chromium, on boiler tubes for protecting the tubes from corrosion – it has a higher heat exchange coefficient (see Section 4.3.8) than the ceramic refractory alternatives.

Techniques have been developed to prevent the formation of solidified ash deposits in the furnace. These include:

- cooling of the furnace side walls - which lowers the ash temperature, causing the ash to solidify before it reaches the furnace wall
- designing the furnace with a lower specific heat load (larger dimensions for the same thermal capacity).

#### **Achieved environmental benefits**

The greater plant availability means that the additional risks of emissions associated with start up and shutdown are reduced.

Retaining heat generated during combustion in the furnace will reduce the need to add support fuels to lower LCV wastes.

The high heat capacity of the refractory lined furnace helps to reduce temperature fluctuations that may arise with wastes of variable LCV, thus promoting more stable incineration and reducing emissions from the combustion stage.

The use of water and air-cooled walls allows:

- the heat to be recovered
- gas temperature reduction, which reduces the stickiness of fly ashes and, hence, improves boiler availability and heat transfer efficiency
- reductions to be made in secondary air addition (where this has been added for gas cooling) leading to lower flue-gas volumes, reduced flue-gas treatment equipment capacity requirements, and possibly lower NO<sub>x</sub> in the raw gas.

Similar effects can be obtained with air-cooled refractory.

#### **Cross-media effects**

Where LCV of the waste is sufficient to maintain the combustion temperature, providing refractory lining over too wide an area can reduce heat transfer to the boiler and hence reduce energy recovery performance.

If support fuels are necessary because the water walls extract too much heat, and this results in combustion temperatures dropping below those required for effective combustion performance, then refractory walls should be used.

#### **Operational data**

Improved plant availability through reduced corrosion and bottom ash build-up.

With lower CV waste, increasing the refractory covering assists with maintaining combustion temperature.

#### **Applicability**

This technique is mainly applied to municipal grate incinerators [64, TWGComments, 2003]

Increasing protection of the boiler tubes by using refractory lining close to the primary combustion zone is mainly applicable where:

- low calorific wastes require additional heat retention in the primary combustion zones
- high chlorine loading give rise to additional corrosion concerns
- high temperature combustion gives concerns regarding corrosion.

### **Economics**

Improved plant availability results in reduced operational costs.

Changing the configuration of the furnace at existing plants may not be practicable due to high costs.

### **Driving force for implementation**

Operational and environmental benefits. In particular, a better incineration process, less furnace corrosion, less maintenance, longer boiler lifetime.

### **Example plants**

Widely used at MSWIs throughout Europe.

### **Reference literature**

[2, infomil, 2002, 64, TWGComments, 2003] [28, FEAD, 2002]

## **4.2.23 Use of low gas velocities in the furnace and the inclusion of empty passes before the boiler convection section**

### **Description**

The furnaces of waste incinerators are normally designed large enough to provide low gas velocities and long gas residence times. This allows combustion gases to be fully burned out, and prevents boiler tube fouling by:

- reducing the fly ash content of the flue-gases
- allowing the temperature of the flue-gases to be reduced before coming into contact with the heat-exchange bundles.

Heat-exchanger fouling may also be reduced by including empty passes (e.g. water walls without obstructions in the gas path) between the main furnace area and the heat-exchange bundles to allow gas temperature, and hence fly ash stickiness, to be reduced. Temperatures of below 650 °C before the convective superheater are used for the reduction of adhesion of ash to the boiler tubes and thus prevent corrosion. [2, infomil, 2002, 64, TWGComments, 2003]

### **Achieved environmental benefits**

Reduced emissions of organic substances from the combustion stage.

Improved heat exchange in boilers owing to a reduction of deposits on boiler tubes. This can result in improved energy recovery.

### **Cross-media effects**

No specific effects identified, but care may be required to ensure secondary air or other mechanisms used to support gas mixing are adequate with larger furnaces.

### **Operational data**

Reductions in boiler tube deposits results in improved process availability and better heat exchange.

### **Applicability**

Mainly applicable to the design of new plants and where substantial re-fits of existing furnaces and boilers are being carried out.

Applicable to nearly all kind of incinerators.

### **Economics**

Larger furnaces are more expensive to construct.

**Driving force for implementation**

Operational benefits from better incineration process, reduced erosion, fly ash and maintenance, and a longer boiler lifetime.

**Example plants**

Commonly applied to MSWI in Europe.

**Reference literature**

[2, infomil, 2002], [64, TWGComments, 2003]

**4.2.24 Determination of calorific value of the waste and its use as a combustion control parameter****Description**

Fluctuations in the characteristics of the waste are more pronounced with some types of wastes (e.g. untreated MSW, some hazardous wastes) meaning that mass and volume are less reliable control parameters. The determination of NCV on line (e.g. as described in 3.5.2) may then help to optimise process conditions and improve combustion with such heterogeneous inputs.

Techniques have been developed based upon:

- retrospective analysis of process performance parameters (not a predictive method)
- mass balance calculations based on CO<sub>2</sub>, O<sub>2</sub> and H<sub>2</sub>O concentrations in the flue-gas (i.e. not a predictive method as based on downstream measurement) and on waste input (averaged values using e.g. a “crane” scale) or on other smaller heat flows estimated
- use of microwave equipment to assess waste moisture content in the feed chute
- waste colour and dimensions linked to plant output signals by fuzzy logic.

**Achieved environmental benefits**

Improved combustion control results in reduced emissions from the combustion stage.

**Cross-media effects**

None identified.

**Operational data**

Knowledge of the calorific value of the fuel input is useful in that it allows optimisation of the air supply and other critical parameters that control combustion efficiency. With heterogeneous fuels, the mass and volume input rate of the fuel can be used as an additional control parameter.

Control of quality of the waste may be part of the delivery contract.

**Applicability**

This technique may be used as a diagnostic tool or (with on-line methods) for process control e.g. MSWI burning heterogeneous waste.

**Economics**

No data supplied.

**Driving force for implementation**

Improving the combustion and energy recovery performance of MSWI's.

**Example plants**

On-line techniques have been used in municipal plants in the Netherlands.

**Reference literature**

[23, VanKessel, 2002] [64, TWGComments, 2003]

### 4.2.25 Low-NO<sub>x</sub> burners for liquid wastes

Low-NO<sub>x</sub> burners provide a means of introducing and burning liquid wastes into the combustion chamber in such a way that nozzle head temperatures are reduced and therefore the production of thermal NO<sub>x</sub> is reduced. Descriptions of low-NO<sub>x</sub> burners used for conventional fuels are given in the LCP BREF (note: these may require specific modifications for use with wastes).

There are relatively few examples where low-NO<sub>x</sub> burners are successfully used with wastes. Particular attention is required to ensure adequate combustion efficiency (with waste). The technique is only applicable to specific liquid waste streams. It may be suited to some liquid hazardous wastes.

The installation of Low-NO<sub>x</sub> burners during plant construction helps reduce the production of NO<sub>x</sub> while adding little to the capital cost. The cost of retrofitting such burners to existing plants, however, can be high.

[64, TWGComments, 2003]

### 4.2.26 Fluidised bed gasification

#### Description

This technique involves the use of a fluidised bed (see 2.3.3) under gasifying conditions (see 2.3.4).

In the fluidised bed, an inert material, like sand, is heated to reaction temperature and kept in a fluidised state by an up streaming gas, i.e. in general air or steam. In a circulating fluidised bed, the bed material is carried out of the reactor due to high gas velocity, collected in a cyclone and returned. In a bubbling fluidised bed the gas velocity is lower, so that the bed material moves only within the reactor. The basic operating principle of an internally circulating/bubbling fluidised bed is shown in Figure 2.25 and a more detailed description in section.

The gasification process may be carried out at high or low temperatures. In low temperature gasification, the waste is heated in the FB to a reaction temperature of usually between 500 and 600 °C and in high temperature systems to 800 to 1000 °C. They are supplied with sub-stoichiometric oxygen levels, to be gasified. The synthesis gas produced in the gasification stage is usually then passed to a combustion stage, but in some circumstances may be purified for use as a chemical feedstock.

In some cases the syngas is cleaned before its combustion, in others not. This depends on the waste content and the combustion/generation options chosen. However most waste materials contain chlorine and other contaminants, which have to be removed from the gas prior to combustion. Syngas cleaning systems based on wet scrubbers and bag filters have been designed.



**Achieved environmental benefits**

Compared to incineration, gasification has the following features:

- at the lower reaction temperature, metals (e.g. steel, copper, aluminium or brass) contained in the waste are not sintered, oxidised or molten, so when separated from the ash/bed material they may have higher value for recycling
- a gas with heating value and chemical potential is generated, which may be used for various recycling or recovery options
- the combustible gas may itself be combusted and the energy generated used for energy recovery
- combination of the gas in special combustion conditions has been used to melt ashes (vitrification), generating a low leaching product (see 4.2.27)
- the separation of the gasification and combustion stages may allow improved process control and result in a more stable overall combustion process
- lower flue-gas volumes and hence improved FGT can result from the use of lower air ratios.

**Cross-media effects**

Compared with grate systems, waste particles are limited to 300 mm, which normally requires some energy for shredding and can affect the availability of the plant. While fluidised beds generate less bottom ash with less fine particle content, more fly ash is generated which requires special attention if not vitrified.

Tars and other pollutants removed at any syngas cleaning stages require management. Wet scrubbing systems result in an effluent which when treated yields a tarry residue that then requires disposal. Dry syngas treatment will also result in an accumulation of the removed impurities. In some cases the tarry residue, which has a calorific value, has been supplied to other industries as a waste derived fuel (information concerning the acceptance criteria/emission controls applied at these external industries was not supplied).

**Operational data**

Where shredders are required to prepare the waste these may experience some difficulties with blockages etc. See comments in Section 4.1.5.2.

Generally, fluidised beds achieve good mixing of the waste and a very homogeneous temperature distribution in the reactor. Due to the very turbulent reaction zone and the large heat content of the bed material, fluidised beds have low sensitivity to changes in the physical and thermal properties of the waste.

Bubbling fluidised beds offer the advantage of a large reaction volume without moving parts, so comparatively large waste pieces (up to 30 cm in diameter) can be gasified.

The following additional operational comments were made by the BREF TWG:

- if metal pieces are in the waste they can throw it out of balance and can accumulate – resulting in operational difficulties
- difficulties may be encountered finding a market for the syngas produced, limiting the options for chemical recovery
- the market may not exist or be any better for the improved ash produced (ash quality improvements may arise from the homogenisation of the waste at the shredding stage and/or the coupling of the techniques with a high temperature post-gasification combustion stage).

### **Applicability**

The main restriction on the use of FB Gasification arises from the need for the waste to be suitable for feeding to a fluidised bed, or readily treatable so that it may be fed to the FB. Wastes which have been fed to such systems include: pretreated (shredded) MSW, shredder residues, waste plastics and other industrial wastes of a suitable size or where they can be shredded to a suitable size. Oils and other liquids, bone meal, sludges and slags are suitable wastes in mixtures with others.

In Europe, although applied to some selected waste streams, in practice the technique has (at the time of writing) yet to be demonstrated on a full operational scale on many waste streams.

### **Economics**

Investment costs are reported to be higher than for conventional grate incineration e.g. JPY 20 billion (approx. EUR 160 million) in 2002 for a plant treating 120000 t/yr of MSW. Cost includes construction and plant costs of an entire plant including: six waste shredder lines, fly ash melting (see 4.2.27), flue-gas treatment, and adjacent integrated offices, swimming pool and spa complex. Cost excludes land purchase.

Operated with air, at atmospheric pressure and moderate temperatures, fluidised bed gasifiers are more economic in construction and operation than other gasification technologies applied for waste.

Revenue incomes are to be expected for materials diverted for recycling. Metals recovered from the gasifier will be disinfected and not require cleaning (cf. removal from the shredder stage) and may be sold at higher value than that recovered from grate incineration ash owing to a reduced level of fusion and oxidation (where they are removed at a lower temperature). Markets for the use of vitrified ashes may be better than for grate bottom ashes due to the improved properties of the material produced – this is the case in Japan but is often not the case in Europe.

Electrical revenues may be reduced due to higher in-process consumption where oxygen generation is used i.e. where the technique is coupled with oxygen enrichment.

Difficulties have been encountered with the shredding stages required to prepare municipal wastes for fluidised beds. The provision of multiple shredding lines can help to reduce the risk of expensive loss of availability, but in turn the provision of such additional equipment adds significantly to costs.

### **Driving forces for implementation**

The following factors promote the implementation of this technique:

- waste within the size range required for the FB or waste which can relatively easily be treated to meet the specification required
- waste has a high calorific value
- requirements for very low leaching residues (such residues are produced where this technique is coupled with a secondary ash melting stage - see Section 4.2.27) either through availability of recycling markets or restrictions on disposal sites
- the higher recycling value of the metals removed from the gasifier can be realised
- a favourable market exists for the use of the syngas as a chemical feedstock.

### **Example plants**

There are several examples in Japan for MSW, sewage sludge, shredder residues, plastic wastes and selected industrial wastes.

There is an operational example in Europe (Spain) treating selected commercial and industrial plastic wastes. This installation uses fluidised bed gasification coupled with syngas cleaning prior to its combustion of electricity generation in gas engines. Tars and other pollutants are removed to a cleaning stage by the syngas cleaning.

It is reported that some experiences in Germany (KWU- Schwelbrennverfahren, Thermoselect, Noell -Konversionsverfahren) of the use of pyrolysis/gasification have had difficulties in reaching their design throughput capacity, and that consequent real treatment costs have escalated. It is also reported that this has in some cases lead to the closure of installations. [74, TWGComments, 2004]

A 50 – 60 MW circulating fluidised bed gasifier has been successfully operated since 1998 on waste derived fuels in Lahti, Finland. The gasification gas is co-combusted in a 350 MW hard coal combined heat and power plant replacing about 15% of the primary fossil fuel. A 50 MW bubbling fluidised bed gasifier for reject plastic material containing 10 – 15% aluminium foil has been operating at Varkaus cardboard mill in Finland since 2001. Part of the plastic waste is a reject from a pulping process recycling fibres of used liquid packaging. Metallic aluminium is recovered from the product gas for material recycling. The gas is fired in a gas fired boiler producing process heat and steam for energy production.

#### Reference literature

[64, TWGComments, 2003]

### 4.2.27 High temperature combustion of gasification syngas with ash melting

#### Description

This technique is an extension of fluidised bed gasification. Syngas from a gasification process and carbon-rich fly ash particles are combusted in a down flow melting chamber. Air and/or oxygen enriched air is introduced such, that a cyclonic flow is induced, which drives ash particles to the wall.

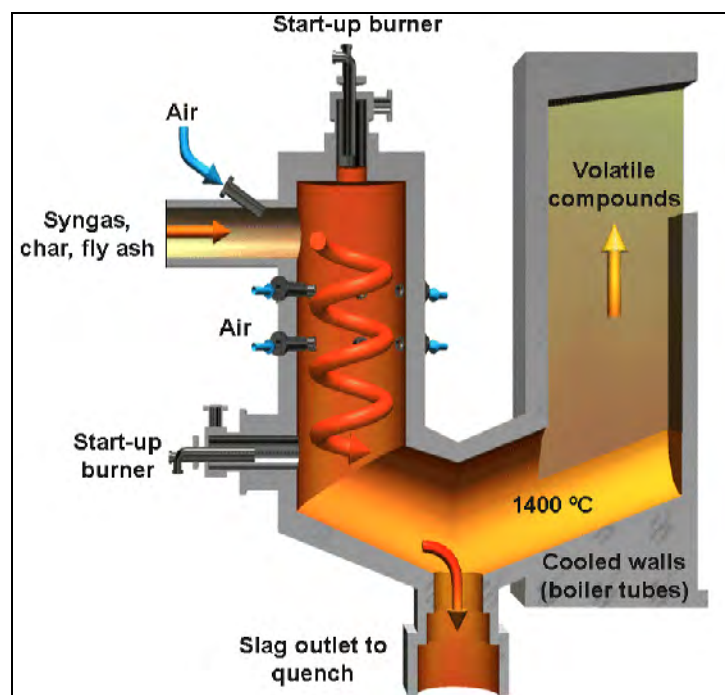

Figure 4.2: Basic components of a cyclonic high temperature syngas ash melting furnace  
Source [68, Ebara, 2003]

The temperature is set to that at which the ash is vitrified (about 1400 °C) and will proceed towards the slag outlet. Due to the high temperature level, halogens and volatile metals, like lead and zinc, are evaporated.

The walls of the ash melting chamber are refractory lined and cooled by evaporator tubes of the boiler. In this way, the refractory is covered by a protective layer of slag, and the heat recovery is achieved.

### **Achieved environmental benefits**

The following benefits are reported:

- very efficient destruction of organic species at the high temperatures used
- vitrification of the fly ash generates a stable low leaching granulate with additional (cf. grate ash) recycling possibilities
- quantities of fly ash passed to the FGT residues are reduced and hence volumes of FGT residues themselves are reduced
- lower contamination of FGT residues with fly ash may enhance FGT treatment options.

Compared with ash melting in a separate, off-line process, integrated ash melting is far more energy efficient, as it is an integrated part of the primary thermal process, where the high temperature required for vitrification is still available for steam production.

### **Cross-media effects**

Vitrification requires high temperatures and, hence, sufficient energy to generate these temperatures. With lower calorific value fuels the temperature may be maintained by adding additional fuels (e.g. natural gas or fuel oils) and/or by increasing oxygen supply to the combustion chamber. The use of an oxygen generator adds an electrical requirement of approximately 0.5 – 1 MW depending on oxygen requirements.

### **Operational data**

Plants using this technology have been in full commercial operation since 2000 in Japan.

Cooling of the refractory walls has proven to enable long refractory lifetimes. From the current level of experience, two annual inspections of the refractory are sufficient.

Some fly ash is re-evaporated and still needs special attention.

The flue-gas may be highly corrosive, and flue-gas treatment is required to remove those pollutants. Energy recovery may be complicated by this corrosivity. [74, TWGComments, 2004]

### **Applicability**

The technique is applicable for gasification plants combined with syngas production when a vitrified fly ash is desired. The restrictions on the applicability of this technique to the various waste types are therefore the same as those to which this technique is connected i.e. where FBs are used many wastes require preparation before they can be treated.

Although applied in Japan, in practice the technique has yet to be demonstrated on a full operational scale in Europe.

### **Economics**

Ash vitrification, even when process-integrated, increases waste treatment costs due to additional investment and operation effort. The resulting overall economics depends highly on the savings resulting from recycling of vitrified ash.

The product is used as a construction material and will most often not generate a higher revenue than mechanically treated bottom ash. [39, Vrancken, 2001]

### **Driving forces for implementation**

The following factors promote the use of ash vitrification using this technique:

- high costs for fly ash/FGT residue treatment/disposal
- high costs for treatment/disposal of bottom ashes
- requirements for very low leaching residues before re-use permitted.

### Example plants

Examples operational in Japan.

It is reported that some experiences in Germany (KWU- Schwelbrennverfahren, Thermostelect, Noell -Konversionsverfahren) of the use of pyrolysis/gasification have had difficulties in reaching their design throughput capacity, and that consequent real treatment costs have escalated. [74, TWGComments, 2004] It is also reported that this has in some cases lead to the closure of installations.

### Reference literature

[64, TWGComments, 2003]

## 4.3 Energy recovery

### 4.3.1 Optimisation of overall energy efficiency and energy recovery

#### Description

Incineration plants can liberate the energy value of waste and can supply electricity, steam and hot water. Where a plant is located so that the supply and use of these outputs can be maximised, this will allow better use of the energy value of the waste.

Energy inputs to incineration plants are mainly from the calorific content of the waste, but may also come from additional fuels added to support the combustion process, and also from imported power (electricity).

The plant itself can use some of the energy generated. The difference between the inputs and the (usable) outputs are the losses. A part of this (usable) recovered energy may be valorised (used). In general, the whole of the electricity generated is valorised but in respect of steam or hot water, it depends on the needs of the user; the most favourable situations being when the users needs are greater all year long than the incineration plant output (e.g. industrial steam use or large district heating network). [74, TWGComments, 2004]

Optimising the efficiency of the plant consists in optimising the whole process. This includes reducing the losses and limiting the process consumption. Increasing energy output does not, therefore, solely equate to the energy conversion efficiency, as it is also necessary to consider the energy required by the process itself and the possibilities of valorisation.

The optimal energy efficiency technique depends, to an extent, on the particular location and on operational factors. Examples of factors that need to be taken into account when determining the optimal energy efficiency are:

- location. Is there a user/distribution network for the energy or can one be provided?
- demand for the energy recovered. There is little point in recovering energy that will not be used. This is a particular issue with heat but generally less of an issue with electricity
- variability of demand. E.g. summer/winter heat requirements will vary. Plants that export steam as a base load can achieve higher annual supply and hence export more of the recovered heat than those with variable output options, who will need to cool away some heat during low demand periods
- climate. In general heat will be of greater value in colder climates (although the use of heat to drive chilling units can provide options where there is a demand for cooling/air conditioning)

- reliability of fuel/power supply. Isolated plants may experience unreliable waste deliveries (related to storage times and capacities) or even electrical supply interruptions that can result in shut downs or greater dependence on the use of self generated power
- local market price for the heat and power produced. Low heat price will result in a shift to electricity generation and vice versa
- waste composition. Higher concentrations of corrosive substances (e.g. chlorides) can result in an increased corrosion risks, thus limiting steam parameters (and hence possibilities for electricity generation) if process availability is to be maintained. The composition can also change depending on the season, including for example holiday seasons which cause population changes in some areas
- waste variability. Rapid and extensive fluctuations in composition can give rise to fouling and corrosion problems that limit steam pressures and hence electricity generation. Variation in waste composition (itself influenced by many factors) over the plant life favours the use of wide spectrum rather than finely optimised design
- high electrical efficiency conversion plants may be attractive when electrical power prices are high, however, frequently more sophisticated technology has to be used with a possible negative effect on availability.  
[74, TWGComments, 2004]

[28, FEAD, 2002] The optimisation of energy recovery techniques requires the incineration installation to be designed to meet the demand requirements of the energy user. Plants that can supply electricity only will be designed differently to plants that have the opportunity to supply heat or those plants that supply combined heat and power.

### Recovery of only heat, as hot water or steam:

The energy recovered can be supplied as hot water or steam (at various pressures). The possible consumers are:

- district heating (DH) and cooling (much less common) networks
- industries, e.g. chemical plant, power plant, desalination plant.<sup>1</sup>

Most of these users require steam, except DH, which can use either steam or hot water. If no steam user is connected to the DH network, hot water can be used as the energy conveyor. With water, the pipes have wider diameters and pumping requires more energy, but the DH operation and the safety measures are easier.

Most modern DH networks use hot water<sup>2</sup>. In this case, the incineration plant boiler can either produce steam or hot water. If the plant also generates electricity (CHP see below), it will be steam. If not, hot water is generally preferred.

Hot water will often be superheated<sup>3</sup>, pressurised and at higher temperature (e.g. 200 °C), in order to facilitate the heat transfer in the exchangers by increasing the heat differential between the heating and cooling mediums.

When the DH uses steam, the steam parameters (pressure and temperature) at the boiler outlet need to be above the highest level required for the DH. In the case of plants supplying heat only, the steam pressure is usually 2 or 3 bar above the DH pressure and the steam is superheated by 2 bar or 30 °C.

---

1) There is one example in Europe (AVR Rotterdam) of coupling between MSWI and desalination plants. This is interesting since thermal desalination plants need steam at low or medium pressure (3 bars in multi-flash, 20 bars in thermo-compression) and usually operate all year.

2) In some cases like in Basle (Switzerland) there are two networks, one DH network with hot water and another network supplying steam.

3) Superheated water is water at a temperature higher than 100 °C.

Electricity only:

Two factors contribute to increasing the TG (Turbo-Generator) electricity output quantity:

1. the high enthalpy of the steam, i.e. its high pressure and high temperature
2. the low enthalpy at turbine outlet, which results from a low temperature of condensation of the steam.

This latter temperature depends on the temperature of the cold source (air or water) and from the difference between this and the turbine outlet temperature.

In addition to electricity, hot water can be produced by the use of a heat exchanger after the turbine. [74, TWGComments, 2004]

CHP (Combined Heat and Power):

The CHP situation reduces the loss of the energy when there is a low heat demand e.g. in summertime for DH. The electricity is generated in the best conditions if the heat bleed is well located in the thermal cycle i.e. low pressure steam is used for heat supply, leaving higher pressures for electricity generation.

With CHP, when the heat demand is high, the pressure at the outlet of the low pressure part of the turbine is constant. The pressure depends only of the temperature of the cold DH water (or other return) and variation of the heat demand can be balanced by an accumulator tank or air cooler. [64, TWGComments, 2003]

When the heat demand is not high the low pressure section of the turbine must be very flexible because the steam flow inside will vary according to the heat demand. For example:

- from the maximum value (100 % electricity production, no heat demand) when 100 % of the steam flow is passed to the low pressure section of the turbine
- to the minimum value: maximum heat demand, when only a minimal steam flow is required for turbine protection.

[74, TWGComments, 2004]

In the case of a CHP, the pressure and temperature of the steam sent to the heat consumer is determined by the location of the bleed on the turbine<sup>4</sup>. The bleed is located in such a way that the difference between the saturation temperature at this bleed and the temperature at the DH head will be around 10 °C. This bleed supplying the DH is usually controlled. This means that the pressure is maintained as a constant.

Priority is usually given to the heat supply but it can also be to the electricity supply. This often depends on the sale contracts.

**Achieved environmental benefits**

Increasing the recovery and effective supply/use of the energy value of the waste replaces the need for the external generation of this energy, resulting both in a saving of the resources and in avoiding the emissions and consumptions of the avoided external energy generation plant. The amount of energy that is available to be recovered from the waste depends on the calorific value of the waste.

[74, TWGComments, 2004]

[30, UBA, 2002] In general, about 0.3 to 0.7 MWh of electricity can be generated in a MSW incineration plant from one tonne of MSW, depending on steam quantity as a function of the waste LCV, the plant size, steam parameters and steam utilisation efficiency.

---

4) In the case of back pressure turbines (without low pressure section), the steam pressure and temperature are those at the outlet of the turbine.

For the co-generation of electricity and heat, an additional 1.25 to 1.5 MWh (full-load hours), of heat per tonne of waste can be supplied, depending on the LCV of the waste, but the electricity generation may be reduced. Site-dependent heat supply opportunities are very significant in such cases. These include:

- geographical location
- normal (district) heat utilisation periods (e.g., in Germany, this is only 1300 – 1500 hrs/yr of a possible 8760 hrs/yr but in Denmark it is between 4000 - 8760 hrs/yr of a possible 8760 hrs/yr where the large size of the DH networks enables year round supply of the whole heat production).

Concerning heat, under favourable conditions, energy supplied after the boiler (as hot water or steam) can be increased to about 90 % of the total energy input to the boiler (not including internal consumption requirements) for an incineration plant operated at base load. Where high conversion efficiency and base load demand are available (i.e. special arrangements made to create such circumstances) with specially prepared high calorific value wastes (in excess of 20 MJ/kg) it is possible to recover a total of 4 – 5.5 MWh of heat per tonne of waste [45, FEAD, 2002]. Such outputs are not available with lower calorific value wastes e.g. untreated MSW – which is generally of LCV between 8 and 12 MJ/kg.

Maximisation of the benefit available from the energy value of the waste is often most likely to be achieved in situations where CHP is used, as this can allow *exergy* maximisation. This is because it allows the higher pressure steam to be used for electrical generation while the remaining steam energy (lower pressures) can still be supplied and used as heat. In individual circumstances where CHP is not possible, other options may give the optimal solution. [64, TWGComments, 2003]

### **Cross-media effects**

The recovery of energy should not impede the safe and effective destruction of the waste. For example, high steam conditions may compromise plant availability if all precautions are not taken. Higher energy efficiency leads to higher investment and maintenance costs and may also lead to lower availability. [74, TWGComments, 2004]

Particular attention must be given to boiler design in the temperature range 450 – 200 °C to ensure dioxin reformation is minimised. e.g. prevention of dust retention in such zones (see Section 4.3.19).

Certain pollution control equipment and techniques have a high energy demand, and whilst removing some FGT components may give rise to improved possibilities for energy recovery (through reductions in in-process energy consumption) this can also result in unacceptably high emissions – a balance is therefore required. Some examples of significant energy demand techniques include:

- bag filters - reduce dust (and other) emissions, multiple filters in series further increase the demand of energy
- SCR - reduces NO<sub>x</sub> and gaseous PCDD/F emissions but, as a tail end FGT system, SCR requires energy for flue-gas heating
- HCl or NaCl regeneration - external evaporation of effluent
- plume reheat - reduces plume visibility
- ash melting - improve ash quality.

In Austria the energy demand of waste incineration plant itself (also known as the “parasitic load”) is in the range of 2 – 3 % of the thermal output (for grate firing or rotary kilns) and 3 – 4 % in the case of FBR. [74, TWGComments, 2004]



### Operational data

The following data summarises the results of surveys carried out by the TWG energy sub-group. The data given shows the range and average values for heat and electricity production and demand per tonne of waste treated. They are annual averages for installations in middle Europe during 2001:

Parameter		Values in MWh/t of MSW treated		Number of plants surveyed
		Range	Range	
Electricity	Production	0.415 – 0.644	0.546	8
	Exported	0.279 – 0.458	0.396	
Heat	Production	1.376 – 2.511	1.922	15
	Exported	0.952 – 2.339	1.786	
Installation energy demand	Total	0.155 – 1.116	0.575	50
	Electrical	0.062 – 0.257	0.142	
Note:				
1. All figures are absolute i.e. no conversion/equivalence factors have been used.				
2. Calculations carried out consistently according to methodologies used by TWG sub-group				

**Table 4.15: TWG energy sub-group survey data for specific energy flows at some European MSWIs per tonne of waste treated**

Source [64, TWGComments, 2003], [29, Energysubgroup, 2002]

### Applicability

The efficiency range that can be achieved, depends importantly on the chemical and physical nature of the waste being burned (i.e. MSW, HW, SS, etc.) as well as its calorific content. In general, higher electrical efficiencies can be achieved where the waste contains lower and/or less variable concentrations of substances that may enhance corrosion in boilers. As high temperature corrosion becomes an increasing problem at higher steam parameters, the need for high plant availability can become a limiting factor.

[29, Energysubgroup, 2002] Quite often, when recovered energy is used as heat, a part of that heat supplied is not actually used. In some cases, the losses from the system which is supplied with the heat may be very significant because the demand is not constantly at full load. Typically the recovered heat may be maximised in situations where:

- the consumer is an industry with a demand for all the energy recovered
- waste can be stored and then burned when heat is required (this avoids wasting fuel energy)
- the needs of the district heating network are greater than the energy supplied by the WI plant.

The last case is most commonly found in cities or other locations with extensive district-heating networks.

Where a suitable heat distribution and use network is not available, this will limit the opportunities and rationale for achieving high levels of heat recovery and hence limit the ability of the process to export all of the available energy, thus making the highest levels of efficiency difficult to reach.

The choice of the site where the plant will be built and the European (climate) zone where it is located (e.g. colder climates are advantageous for heat export) are therefore critical in determining the available energy outlets, and hence the attainable efficiency.

Therefore, when comparing the achieved (and achievable) efficiencies of existing plants, it is important that the location of the installation is taken into account.

Opportunities for increasing overall energy recovery from new WI plants can therefore be seen to be greatest at the time when the location of new plants are being selected. The decision to locate a plant so that it may be economically connected to a suitable energy distribution network will generally have a much greater influence on overall energy recovery than the technological choices made in the operating plant.

Decreasing installation energy demand may involve decisions regarding the type and extent of FGT system used. A balanced approach to such decisions is appropriate i.e. one that takes account of the general desire to reduce installation energy requirements and the degree to which pollutants should be abated.

### **Economics**

Higher relative treatment costs at smaller plants and the lack of economy of scale tend to lead to a lower availability of capital for investment in the most sophisticated energy recovery techniques. This, in turn, means that lower efficiencies can be expected at smaller installations e.g. municipal waste incinerators below 100K tonnes/yr throughput.

The prices paid for supplied electricity and heat have a major influence upon the economics of investments made to increase these outputs. In some cases, subsidies are paid that provide very attractive prices for electricity production. In other cases, a high demand for heat can result in favourable prices for heat. In such cases, the income to be derived from these sources can make capital investments to increase output more favourable.

For plants supplying electricity only, increasing electrical efficiencies induce higher revenues from the additional electricity generated/sold, but also involve higher investment costs and often higher maintenance costs. Therefore the price of the (sold) kWh will play a key role in the choice of a solution. [74, TWGComments, 2004]

For CHP plants, the larger the quantity of energy exported as heat, the lesser benefit will result from improved efficiency on the electricity generation. [74, TWGComments, 2004]

### **Driving force for implementation**

The main driving forces for increased energy efficiency are favourable economic conditions. This in turn is affected by factors such as:

- climate
- location
- prices for heat and power.

Higher income from energy sales can, in particular, allow:

- increases to be made in electrical export efficiency to between 20 and 30 % (e.g. 0.6 - 0.9 MWh/tonne for an untreated mixed MSW of 2.9 MWh/t). The higher levels are achieved through the use of waste pretreatment systems (note that pretreatment stages often require energy and can use all and more of that to be gained by increased efficiency at the incineration stage) including RDF production for fluidised bed combustion, and increased steam parameters beyond 40 bar 400 °C
- investment in heat or steam supply networks to increase the ability to use the available energy, to give efficiencies in the order of 80 to 90 % (e.g. >2.3 MWh/tonne for an untreated mixed MSW of 2.9 MWh/t) where there is a year-round heat demand
- investment in techniques to capture the available heat from low temperature sources that might otherwise not be economic e.g. condensing scrubbers and heat pumps (see later sections).

In terms of optimising the energy recovery, reducing the technical risk and reducing costs, heat supply is favourable where this is possible. However this still depends on the local conditions, and significantly on the respective sale prices of electricity and heat. If a (substantial) part of the heat cannot be used, then CHP might well be the right solution. If no heat can be sold, then good practice is generally to use the available energy to create electricity.

Heat:

The client demand is the key driving force. Therefore location is of great importance.

An important factor is the duration of the contract to receive heat. Often industrial clients cannot commit themselves for more than one or two years. This does not fit well with incineration plants, where a project can require several years before the plant even starts; and incineration plants financing and operation is usually long term (15 – 25 years).

The most favourable situation is when the recovered heat can be entirely sold for heat use. This may occur with industrial customers or with DH either in colder climates or for very large DH with a “base” load higher than the plant output<sup>5</sup>.

Where all the recoverable heat cannot be sold, the aim is then to try to use the remaining energy for generating electricity. The decision depends on the remaining quantity of energy and on the capital investment and income costs to be derived from electricity sales.

CHP:

Generally CHP provides a solution for increasing overall energy output when only part of the heat can be sold. CHP is especially effective if the temperature level of the required heat is low.

Electricity:

If there is no customer for the heat, the only option is then to generate electricity. Increasing electrical output can be achieved by using increased steam parameters (see Section 4.3.8). The choice of the steam parameters (high or low) is most commonly taken on an economics basis. The technological risk is also a factor as this increases where higher steam parameters are used (e.g. above 40 bar 400 °C for mixed municipal waste), and, if not well managed and maintained the plant may then experience losses of availability.

**Example plants**

Municipal incineration plants:

- Renova, Gothenburg and Dyvamuren (Umea), Sweden – high levels of internal energy integration with a view to maximising heat supply to local networks
- Odense, DK - use of special claddings in boilers to allow high steam parameters and electrical output
- Indaver, Beveren, B - supply of process steam directly to neighbouring industry.

Example of MSWI plants generating hot water for district heating:

- Rungis (south of Paris, France)
- Villejust (south of Paris, France)
- Caen (France)
- Thiverval-Grignon (West of Paris, France)
- Nantes East (France).

Example of plants providing steam for district heating:

Three plants in France supply steam for DH for over 200000 flats in Paris:

- Issy-les-Moulineaux (SW of Paris, France)
- Ivry (SE of Paris, France)
- St Ouen (NW of Paris, France).

5) Some plants that report 100 % export of the heat that they recover actually supply steam to another company which then turns it into electricity e.g. Brussels, Belgium; Metz, France; Vancouver, Canada. Among 8 German plants selling heat only, all the plants which sell a high quantity of heat per tonne of waste, supply their heat directly to a power station and, usually, exclusively as process steam.

Examples of plants providing steam to industry:

- Nantes (F)
- Rambervilliers (F).

Examples of plants generating electricity only:

- Mataro (Spain)
- Chineham (UK).

Examples of MSWI plants providing steam to electricity generation installations:

- Brussels (Belgium)
- AZN Moerdijk (NL)
- Several examples in Germany
- Vancouver (Canada).

[74, TWGComments, 2004]

Examples of hazardous waste plants:

- Ekokem, (FIN) - electricity generation and heat supply
- Indaver, Antwerp, (B) – on-site use of steam for other processes.
- HIM, Biebesheim (D) – on-site use of steam for evaporation of oil/water wastes
- German chemical industry (19 plants, capacity >500.000 t/yr) with on-site use of steam for other processes, electricity (4 plants) and additional district heating.

### Reference literature

[29, Energysubgroup, 2002], [28, FEAD, 2002], [30, UBA, 2002], [5, RVF, 2002], [64, TWGComments, 2003]

## 4.3.2 Energy loss reduction: flue-gas losses

### Description

[28, FEAD, 2002]

Flue-gas losses correspond to the heat leaving the plant (usually considered at the boiler level) with the flue-gas. The actual loss depends on the flue-gas flow and on its temperature (enthalpy).

Some possibilities for reducing these losses are:

- reduce the flue-gas flow; to achieve this several options are possible:
- reduce excess air e.g. improve primary and/or secondary air distribution
- recycle flue-gas, i.e. replace a part of the secondary air by flue-gas
- enrich the combustion air in O<sub>2</sub>, i.e. increase the proportion of O<sub>2</sub> and decrease the one of N<sub>2</sub> by O<sub>2</sub> injection (only in special cases is this carried out - see Section 4.2.13)
- reduce the flue-gas temperature, e.g. by using flue-gas condensation or by decreasing the temperature at the boiler exit - see techniques described later in this section.
- selecting FGT facilities with decreasing temperatures from the boiler to the stack as far as possible. [74, TWGComments, 2004]

### Achieved environmental benefits

By using techniques to reduce flue-gas losses the additional energy recovered can be supplied for use.

**Cross-media effects**

Reducing the gas flow by reducing the excess air and FGR can increase corrosion risks and therefore can require additional technical remedies. If levels are reduced too far this may jeopardise the gas burnout and leave PICs in the flue-gas.

Oxygen injection can increase combustion temperatures. If not carefully controlled, this may lead to clogging, and risk of destruction of refractory and ferrous materials.  
[74, TWGComments, 2004]

The significant energy consumption for generating the required O<sub>2</sub> is higher than the achieved reduction of the energy loss making the technique not viable if the only benefit considered is the energetic balance – other benefits of enriched oxygen (e.g. improved combustion) may, however, provide for an overall justification for this technique. [64, TWGComments, 2003]

Reducing gas temperatures at the boiler exit below the temperatures required to operate subsequent flue-gas treatment devices, will lead to additional energy requirements to reheat the flue-gases in order to operate those devices, as well as increased risk corrosion in economisers. This is a particular issue for bag filters and for SCR devices.

Lower flue-gas temperatures at the stack exit can result in:

- highly visible condensed plumes (less of a problem if condensing scrubbers are used as they reduce the water content of the flue-gases)
- reduced plume buoyancy and, hence, dispersion
- corrosion in stacks (lining with fibreglass or similar required).

**Operational data**

For a municipal waste incineration plant the energy losses via the flue-gases are typically in the range of 13 - 16 % of the energy input from the waste.

**Applicability**

Optimisation of the boiler outlet temperature can be carried out at all plants. The extent to which it can be reduced will need consideration of the energy requirements of downstream FGT equipment, and the acid dew point of the flue-gas.

New installations have the most significant opportunity for designing in techniques to reduce losses from flue-gases. Plants that have an outlet for the supply of relatively low temperature heat (most common in colder climates) are best placed to make use of the additional heat removed from the flue-gases. Where this heat cannot be supplied, or used within the plant, this low grade heat may be better employed within the flue-gas to aid dispersion, etc.

Changes to the design exit temperature of the boiler must take account of the requirements of subsequent flue-gas cleaning operations. The removal of heat that must later be re-added from another source is likely to be counterproductive from an energy efficiency point of view, owing to additional losses from the heat exchange process.

**Economics**

Information not supplied.

**Driving force for implementation**

Reduction of overall process energy consumption and increase of energy valorisation products.  
[74, TWGComments, 2004]

**Example plants**

Many plants in Europe, e.g. Brescia Italy

**Reference literature**

[28, FEAD, 2002], [64, TWGComments, 2003]

### 4.3.3 Increasing burnout of the waste

#### **Description**

Good burnout results in a high conversion of fuel to energy. Therefore, techniques that ensure effective burnout and hence low TOC levels in ash may contribute, to some degree, to improved energy efficiency. Combustion techniques that agitate the waste well, and retain wastes within the combustion zone to allow unburned carbon in the bottom ash to enter the gas phase for combustion will assist.

Techniques to increase burnout are described in Section 4.2.17

#### **Achieved environmental benefits**

Extraction of energy value from the waste for possible recovery/use.

Improvement of residue quality by decreasing the proportion of unburned material left in it.

See Section 4.2.17 for further information.

Diminishing energy returns are seen as waste is progressively burned out to a greater extent. This is because the amount of energy remaining in reasonably well burned out waste is low. The main benefit to be obtained from increased burnout is therefore less one of energy recovery and more one of improving residue quality.

### 4.3.4 Reducing excess air volumes

See comments in Section 4.3.2 for further information.

### 4.3.5 Other energy loss reduction measures

#### Description

In addition to other techniques described in this document (see Sections 4.3.2, 4.3.3, 4.3.12), the following losses and reduction techniques can be used:

Description of energy loss	Techniques to reduce losses	Comments
Heat radiation and convection - mainly from furnace and boiler	<ul style="list-style-type: none"> <li>lagging</li> <li>build plant inside building</li> </ul>	For a municipal plant losses can be limited to approx. 1 % of energy input.
Losses with solid residues (bottom and fly ashes)	<ul style="list-style-type: none"> <li>good waste burnout</li> <li>use heat from slag bath</li> </ul>	For a municipal plant losses are in the order of 0.5 % - 1.0 % - most with bottom ash.
Boiler blowdowns and effluent	Re-use of the energy in the water for building heating at the plant.	closed loop for cooling purposes
Fouling of boiler reduces heat transfer efficiency	<ul style="list-style-type: none"> <li>Design to lower the boiler fouling rate</li> <li>Effective boiler cleaning - see Section 4.3.12</li> </ul>	
Start-up and shutdown procedures	Avoid SU and SD by design and procedures for continuous operation and good maintenance	Example: design to reduce boiler fouling may reduce SU and SD frequency and improve availability.
Fast changes in waste characteristics or heat demand	<ul style="list-style-type: none"> <li>waste mixing and quality assurance/control</li> <li>supply heat to buffer storage network</li> </ul>	Techniques that increase stability of input and output will assist ability to optimise for the local circumstances.
Plant failures/outage	Maintenance procedures to prevent failures	Some outages may result in partial shut-down of energy recovery equipment (e.g. TG set). Others may require waste diversion from the plant and hence loss of throughput where storage is not an option.
Reductions/variations in external demand for energy	<ul style="list-style-type: none"> <li>secured contracts with user improve possibility of maximising supply of recovered energy</li> <li>supply of heat to buffer storage network</li> </ul>	External demand for the recovered energy has a major impact on ability of the plant to supply the energy. Generally more of an issue for heat than electricity.
Losses by measuring devices and instruments	<ul style="list-style-type: none"> <li>Use of measuring systems with low pressure drop and precise results</li> </ul>	New instruments allow e.g. for steam measuring nearly zero losses with high accuracy.

Notes: SU = start-up, SD = shutdown

**Table 4.16: Techniques for the reduction of various energy losses at WI plants**

Source adapted from [28, FEAD, 2002], [74, TWGComments, 2004]

#### Achieved environmental benefits

The additional energy recovered may be supplied for use.

#### Cross-media effects

Information not supplied.

#### Operational data

Furnaces, boilers and some ducting are commonly covered with rock wool lagging or other insulating material to limit heat losses and to limit external temperatures for operator safety. [74, TWGComments, 2004]

#### Applicability

The techniques described can help to reduce losses at all installations. However, site-specific factors may mean that some techniques are not locally available or not relevant (e.g. heat recovery from slag discharger, blowdown or heat buffer storage are considered only where heat at low characteristics can be sold all year around) [74, TWGComments, 2004]

### **Economics**

Information not supplied.

### **Driving force for implementation**

Information not supplied.

### **Example plants**

Information not supplied.

### **Reference literature**

[28, FEAD, 2002], [64, TWGComments, 2003]

## **4.3.6 Reduction of overall process energy consumption**

### **Description**

The incineration process itself requires energy for the operation of the plant. This energy can be recovered from the waste. The amount of energy required depends upon the type of waste being burned and the design of the plant.

The reduction of the installation energy requirement needs to be balanced against the need to ensure effective incineration, to achieve treatment of the waste and control of emissions (particularly to air).

Common sources of significant process energy consumption are:

- Induced and forced draught fan to overcome pressure drops and for combustion air
- waste transfer/loading equipment (e.g. pumps/cranes and grabs/screw feeders)
- air-cooled condensers
- waste pretreatment (shredders, etc.)
- flue-gas heating for specific air pollution control devices (e.g. bag filters, SCR systems)
- flue-gas reheating for reduction in plume visibility
- fuels for combustion support and start-up/shut down (most common for low CV wastes)
- wet flue-gas treatments, which cool flue-gases greater than semi-wet and dry systems
- electricity demand from other devices.

In many cases, particularly where a step change in FGT technology is required, the lower the ELVs the more energy is consumed by the FGT system – it is therefore important that the cross-media impact of increased energy consumption is considered when seeking to reduce emission levels.

The following techniques and measures can reduce process demand:

- avoiding the use of unnecessary equipment
- using an integrated approach to target overall installation energy optimisation rather than optimising each separate process unit [74, TWGComments, 2004]
- placing high temperature equipment upstream of lower temperature or high temperature drop equipment
- the use of heat-exchangers to reduce energy inputs e.g. for SCR systems
- the use of energy generated by the WI plant that would otherwise not be used or supplied, to replace the import of external energy sources
- the use of frequency controlled rotating equipment for those equipment parts which operate at variable speeds, such as fans and pumps, where they are effectively often operated at reduced load. This will reduce their average energy consumption substantially, because pressure variations will be realised by varying speeds and not by valves.



**Achieved environmental benefits**

Reducing the process demand reduces the need for external energy generation or allows the export of greater quantities of energy. The additional energy recovered may be supplied for use.

**Cross-media effects**

Reducing energy consumption by FGT equipment design and operation can result in increased emissions to air.

**Operational data**

[28, FEAD, 2002]

For a municipal incineration plant, the electricity consumption is typically between 60 and 190 kWh/t of waste, depending on the LCV.

An average electricity self-consumption value of 75 kWh/t of waste is reported for: a MSWI incinerating waste of LCV 9200 kJ/kg; generating electrical power only (not heat); complying with EC/2000/76 ELVs using a semi-wet cleaning system and SNCR de-NO<sub>x</sub>; no de-plume device. In a MSWI such as this one, without pretreatment, flue-gas reheating, or plume visibility reduction reheating the main electrical consumptions are roughly:

- induced draught fan : 30 %
- forced draught fan : 20 %
- feed pumps and other water pumps : 20 %
- air-cooled condenser : 10 %
- others : 20 %.

[74, TWGComments, 2004]

Larger throughput plants have an economy of scale, which results in lower energy consumption per unit of waste treated. This is shown in Table 4.17 below:

MSWI plant size range (t/yr)	Process energy demand (kWh/t waste input)
Up to 150000	300 – 700
150000 – 250000	150 – 500
More than 250000	60 – 200

**Table 4.17: Plant throughput and total process energy demand for MSWI in Germany**

Source [31, Energysub-group, 2003]

The size of such economies of scale may be less dramatic than the example data suggests above. The generally higher parasitic load values seen in the table above, are most likely to be explained by the application of complex, retrofitted FGT systems that have often been applied in Germany in order to guarantee emission levels at values sometimes well below 2000/76/EC. [64, TWGComments, 2003]

**Applicability**

Much of the additional energy consumed arises from the application of additional flue-gas treatment techniques that themselves consume energy. Reducing process energy consumption by eliminating these components is less appropriate where there are local environmental drivers that justify further reductions in emissions.

Options for optimisation are greatest at new installations - where it will be possible to examine and select from a variety of overall designs in order to achieve a solution that balances emission reduction against energy consumption.

At existing installations, options may be more limited, owing to the expense (and additional technical risk) associated with complete re-design. Plants that have been retrofitted to achieve particular emission limit values generally have to fit tail-end gas cleaning equipment and will therefore have higher energy consumption figures.

### **Economics**

Operational cost savings may be made by reducing the external process energy demand. Where the energy saved can be exported this can result in additional income.

Capital costs of significant re-design at existing plants may, in some cases, be large in relation to the benefits that can be achieved.

### **Driving force for implementation**

Additional income from energy sales or reductions in operating cost due to reduced energy use.

### **Example plants**

Information not supplied.

### **Reference literature**

[28, FEAD, 2002], [31, Energysub-group, 2003], [64, TWGComments, 2003]

## **4.3.7 Selection of turbine**

### **Description**

The main types of turbine in common use in incineration plants are:

- back pressure turbines
- condensing turbines
- extraction condensing turbines
- double stage condensing turbines.

Back pressure turbines are used when a significant and possibly constant amount of heat can be supplied to customers. The back pressure level is dependent on the required temperature level of the supplied heat. The exhaust pressure of a back pressure turbine is above atmosphere (e.g. 4 bar abs.) [74, TWGComments, 2004]

Condensing turbines are used when there are few or no possibilities to supply heat to customers and the recovered energy is to be converted into electricity. The efficiency of the electricity production is influenced by the applied cooling system (see also 4.3.9). The exhaust pressure of a condensation turbine is under vacuum (e. g. 0.2 bar abs.) and the low pressure part of a condensation turbine is much bigger. [74, TWGComments, 2004]

The extraction condensing turbines are condensing turbines with a significant extraction of steam at intermediate pressure for some purpose. There are nearly always some extraction(s) for the process use on a condensing turbine. Extraction condensing turbines are used when a significant and varying amount of heat or steam can be supplied to customers. The required amount of (low-pressure) steam is extracted from the turbine and the remaining steam is condensed.

Double stage condensing turbines heat up the steam between the two stages by using some of the input steam for superheating the steam in the second stage to reach higher energy production at low condensation temperatures, without damaging the turbine. [74, TWGComments, 2004]

### **Achieved environmental benefits**

The type chosen has an influence on electricity production and energy output.

Steam tapping results in optimised energy use. Savings in fossil fuels lower pollutant and greenhouse gas emissions by reduced use of additional power from external generation stations.

### **Cross-media effects**

Low condensation temperature at the end of the turbine may cause corrosion by high humidity in the steam. [74, TWGComments, 2004]

**Operational data**

Turbines in MSWI plants are usually not very big, typically 10 MW (range from 1 MW to 60 MW). The number of bleeds is usually limited to 3 or 4 (which is different to power plants where a turbine can have many more bleeds).

The low pressure section of the turbine needs a minimum steam flow for cooling the blades, for avoiding vibrations and for preventing condensation.

If the remaining steam flow is too small in some operating conditions, instead of one turbo-generator with a high pressure section and a low pressure section, it is also possible to have two turbines (one high pressure, one low pressure). The choice is made in function of the local conditions and the optimum choice may vary with time. [74, TWGComments, 2004]

In order to improve the electrical generation output with condensation turbines, the steam required by the incineration process (e.g. for the deaerator, air heater, soot blowers) is normally taken from the turbine after its expansion in the high pressure part of the turbine. This is made by "bleed(s)" (also called "extraction" or "tapping"). These "bleed(s)" are said to be 'uncontrolled' because the pressure depends on the turbine load (the pressure can be divided by two at a bleed when the steam flow is reduced by 50 %). The bleed(s) are located in such a manner that the pressure(s) are high enough for the process requirement whatever is the load of the turbine

**Applicability**

The turbine selection must be made at the same time as the rest of steam cycle characteristics and depends more on external aspects than the incineration process. [64, TWGComments, 2003]

**Economics**

Information not supplied.

**Driving force for implementation**

Information not supplied.

**Example plants****1. RMVA Köln, Germany**

By steam tapping from a condensation turbine, various uses for the energy are found and overall energy use can be optimised. The steam is carried to the turbine at a temperature of 400 °C and at a pressure of 40 bars. The tapping of the steam at approximately 300 °C and 16 bars for local and remote steam use and tapping at approx. 200 °C and 4.8 bars for purely local use means that the energy can be exploited to the best possible effect.

The steam is used locally for air and water preheating for local systems and buildings, here particularly as process heat for steam generation, and also for cleaning exhaust air. The remote steam is primarily used to support production processes, but is also used as a remote source for heating. [64, TWGComments, 2003]

**2. Rennes plant - Retrofit**

2 lines of 5 t/hr each of waste producing steam at 26 bar abs and 228 °C (saturated) for the DH. In 1995, a third line of 8 t/hr of waste was added producing steam at the same pressure and 380 °C (150 °C of superheat).

A TG set of 9.5 MVA receives the mixed steam from the 3 lines with an intermediate superheat. However, the TG set can run with any of the 3 lines shut down. This means that it can run with the superheat of 150 °C when the 2 lines of 5 t/hr are stopped but also with saturated steam when the 8 t/hr line is off. The turbine uses only saturated steam.

### 3. Three plants in Paris

These plants are incinerating a total of 1800000 t/yr and supply to the Paris District Heating network 4000000 t/yr of steam (2900000 MWh/yr), which corresponds to 45 % of the needs, and also generate 290000 MWh/yr of electricity, of which 160000MWh/yr are supplied to the national grid.

Steam is delivered at a pressure adjusted by valve between 12 and 21 bar according to the DH requirements and is delivered directly to the DH network without heat exchangers. A varying part of the steam comes back as condensate. The demineralisation plants are able to produce 2/3 of the steam flowrate.

The large size of the DH demand in comparison to the steam generated and the fact that the 3 plants supply the same DH, belong to the same owner and are operated by the same company leads to these specific choices for the equipments.

[74, TWGComments, 2004]

### Reference literature

[64, TWGComments, 2003]

### 4.3.8 Increased steam parameters and application of special materials to decrease corrosion in boilers

#### Description

Higher steam parameters increase the turbine efficiency and result in higher electricity production per tonne of waste burned. However, because of the corrosive nature of the gases evolved from the waste when it is burned, incinerators cannot use the same temperatures and pressures as some primary power generators e.g. 100 – 300 bar and 620 °C. For example, a normal maximum temperature is 540 °C in coal power plants.

There is a distinction between:

- the steam pressure which gives the temperature (saturation pressure) in the water walls (which can be protected by claddings) and in the heat exchange bundles
  - the steam temperature (superheated steam) which gives the temperature in the superheaters.
- [64, TWGComments, 2003]

In general, unless special measures are taken to avoid the effects of corrosion (that result in reduced installation availability and increased costs), MSWI are generally limited to 40 - 45 bar and 380 - 400 °C. Above these values there is a trade off between:

- costs of special measures e.g. special materials to reduce corrosion
- costs of lost availability where increased maintenance is required
- value of any additional electricity produced.

To reduce the effects of corrosion, nickel/chromium (main components) alloy claddings or other special materials can be used for protecting exposed heat exchange surfaces from the flue-gases. The cladding usually starts after the refractory and can cover the first pass and the beginning of the second pass of the boiler. The refractory wall can also be air-cooled (slight overpressure) to reduce corrosion of the tubes behind the refractory. Ceramic tiles are also used to protect boiler tubes.

High temperature corrosion of membrane walls and super-heaters can be reduced by lowering the flue-gas temperature under 650 °C before the superheaters and/or protecting heat-exchange surfaces with ceramic tiles or special alloys.

The main advantage of special alloys over a ceramic cover on the furnace walls is the better transfer of heat to the boiler, resulting in a lower temperature of the flue-gases before the first convection bundles.

An alternative to cladding is to install composite boiler tubes. Composite tubes consist of two tubes, inner and outer, metallurgically bonded together. They come in different alloy combinations. Installations in waste incineration boilers have been made since the seventies. [64, TWGComments, 2003]

#### **Achieved environmental benefits**

Higher electrical output per tonne of waste burned can be achieved by the increase of steam pressure and/or temperature. This higher efficiency reduces external (e.g. in power plants) use of fossil fuel (resource saving) and the related CO<sub>2</sub> emissions (GHG). [74, TWGComments, 2004]

#### **Cross-media effects**

Increased steam parameters without the application of special anti-corrosion measures increases risk of corrosion and associated maintenance costs and availability loss.

#### **Operational data**

This technique involves an increased technological risk and requires skill levels for assessment and maintenance.

#### **Applicability**

The use of increased steam parameters is applicable to all incinerators recovering electricity only, or where the heat proportion of CHP is low, to increase electricity outputs.

The technique has a limited applicability to processes that have reliable options for the supply of steam or heat, since there is no need to increase electrical output, with the associated additional technical risk and costs, and the steam/heat energy can be supplied.

The use of claddings and other special materials is applied to reduce corrosion when using increased steam parameters and/or highly corrosive waste content.

Existing plants that have experienced rising LCV in the waste supplied may benefit from the use of special materials and claddings because it can reduce the maintenance costs and allow improved electrical outputs.

#### **Economics**

The cost of cladding can be discounted against reduced maintenance costs and income from electricity sales and improved plant availability.

Cost of cladding has been reported to be approx. EUR 3000/m<sup>2</sup>.

The range of increase in income depends on the energy price obtained.

[32, Denmark, 2003] The Table below is based on actual electricity and heat prices in Denmark and on real operational data for a modern CHP MSWI of 34 t/h capacity. The table shows the outputs and income at various steam parameters:

Steam value	bar	50	40	30
Generator output	MW	19.6	18.6	17.3
Heat production	MJ/s	71.2	72.2	73.5
Change in electricity output	MW	0	-1	-2.3
Change in heat output	MJ/s	0	1	2.3
<b>Economy</b>				
Availability	hr/yr.	8000	8000	8000
Electricity price	EUR/MWh	47	47	47
Heat price	EUR/MWh	18	18	18
<b>Annual income change</b>	<b>million EUR/yr</b>	<b>0.0</b>	<b>-0.25</b>	<b>-0.54</b>

**Table 4.18: Example energy outputs and income at various steam pressures for a CHP MSWI using elevated steam pressures**  
[32, Denmark, 2003]

According to this example, taking into account energy prices in Denmark, increasing steam pressure from 40 to 50 bar results in an additional annual income approx. 250000 EUR. Calculated over an operational period of 15 years (at 2002 inflation rates) this gives an additional income of approx. EUR 2.5 million.

These figures do not include the additional capital cost required to increase pressures from 40 to 50 bar. In this case these additional costs were considered not to be significant (over 15 years) compared to the additional income gained over the same period.

A change of the pressure might mean a complete change of the piping and the valves of the vessel and also a change of the steam drum which would then lead to the need to apply for a new permit under the Pressure Equipment Directive 97/23/EC. [74, TWGComments, 2004]

### Driving force for implementation

Higher electricity prices will encourage adoption of this technique, as it will allow faster payback of the investments required.

### Example plants

High Steam Parameters:

Odense (Denmark) 50 bar 520 °C with cladding.

AVI Amsterdam, AVR Botlek, AVR AVIRA and AVI Wijster, all in the Netherlands.

AVE-RVL Lenzing, Austria: circulating fluidised bed receiving various waste fractions including approx 60 % plastics produces steam at 78 bar and 500 °C.

Ivry, France (75 bar, 475 °C),

Mataró, Spain (60 bar, 380 °C),

Lasse Sivert Est Anjou, France (60 bar, 400 °C),

Retrofit improvement :

Rennes, France, 26 bar, 228 °C (saturation state); when 3rd line added its boiler rated at 26 bar, 380 °C; the 2 mixed steams sent to the TG.

Application of special materials:

Retrofit improvement : Toulon, Thiverval (F), Mataro (Sp), Stoke on Trent (UK);

new plant : Lasse Est Anjou (F)

[74, TWGComments, 2004]

**Reference literature**

[32, Denmark, 2003], [28, FEAD, 2002], [2, infomil, 2002], [3, Austria, 2002], [64, TWGComments, 2003]

**4.3.9 Reduction of condenser pressure (i.e. improve vacuum)****Description**

After leaving the low-pressure section of the steam turbine, the steam is condensed in condensers and the heat is then passed into a cooling fluid. The condensed water from steam is generally recirculated and used as boiler feed water [74, TWGComments, 2004]

The temperature of the cold source at the turbine outlet is important for the turbine production. The colder the cold source the higher the enthalpy drop and, therefore, the higher the energy generation. For reasons of climate conditions, it is obvious that it is easier to achieve this low pressure in cooler climates. This is one reason why northern installations can give better efficiency than they can in southern countries. [64, TWGComments, 2003]

The lowest temperatures are obtained by condensing the steam, using either air or water as cooling fluid. These temperatures correspond to pressures below the atmospheric pressure (i.e. vacuum).

Where a large DH network uses all year long the full load production of the MSWI, as occurs in Sweden or Denmark, the cold source is the cold water returned by the DH which can be sometimes very low (e.g. 40 °C or 60 °C, see Table 4.19 in Section 4.3.16)

Vacuum is not “unlimited”. As soon as the steam crosses the saturation line of the “Mollier” diagram, it starts to be wet and the percentage of moisture increases with the expansion of the steam in the turbine. In order to avoid damage to the end stages of the turbine (erosion by water drops), the amount of moisture must be limited (often around 10 %). [74, TWGComments, 2004]

**Achieved environmental benefits**

Increased electrical energy generation is possible by improving the vacuum.

**Cross-media effects**

In an open loop, i.e. a *once through* cooling hydro-condenser, assuming a water temperature increase of 10 °C, the water flow needed will be around 180 m<sup>3</sup>/MWh generated.

In a closed loop with a cooling tower, the water consumption (evaporated water) is approx. 2.5 or 3 m<sup>3</sup>/MWh generated.

Both open and closed loop systems may require the addition of chemicals, or other techniques, to reduce fouling in the heat exchange system as well as eventual process water treatment. The impacts of discharge are much larger for open systems.

Low condenser pressure increases humidity in the steam which can increase wear in the turbine [74, TWGComments, 2004]

Air condensers give noise emissions. Detailed design (e.g. shielding, frequency converter noise level, etc.) is therefore important.

Cleaning of the surface of condensers is very important for its efficiency and should be carried out at low temperatures. [74, TWGComments, 2004]

### Operational data

Condenser pressure/condenser types:

With an ACC (Air-cooled Condenser) and air at 10 °C, typically a pressure in the condenser of 100 to 85 mbar absolute can be obtained, depending on the condenser surface. When the ambient air temperature is 20 °C, the pressure in the same ACC will be respectively 200 to 120 mbar absolute. The design is a compromise between a reasonable heat exchange surface and low condensation pressure. [74, TWGComments, 2004]

With **hydro-condenser** (once-through cooling condenser, open loop) using river water at 10 °C, the pressure in the condenser will be around 40 – 80 mbar absolute, because the heat exchange is easier with water.

With an **atmospheric cooling tower**<sup>6</sup>, the temperature of water is bound to the temperature of the air and to its hygrometry (temperature of the humid bulb). If the wet bulb temperature is 10 °C the condenser pressure will be around 60 mbar. The steam plume above the tower can be reduced (but not deleted) by tower design and there will be a slight increase in the condenser pressure. This type of cooler may involve risk with respect to legionella, due to water evaporation and direct contact. It is mainly applied for small cooling requirements (such as turbine auxiliaries). [74, TWGComments, 2004]

According to overview calculation an increase in electrical energy generation from 24.1 % to 25.8 % (+ 7 %) if vacuum improves from 100 mbar to 40 mbar. [64, TWGComments, 2003]

### Applicability

Where electrical generation is of lower priority (e.g. where heat supply is possible) the turbine outlet pressure can be above atmospheric. In this case, the turbine is said to be operating with back pressure and the (remaining) steam is condensed in the condenser itself.

Air-cooled condensers are often the only possible type applicable. [74, TWGComments, 2004]

Open loop hydro-condensers are only suited to locations where there is an abundant water supply that can tolerate the heating effect of the subsequent discharge.

The gains in electrical output are greater with the reduction of condenser pressure and the techniques are therefore, of greater benefit for condensing turbines. [64, TWGComments, 2003]

### Economics

The use of higher pressure reduction techniques will be most economic where electrical energy has a higher price.

For ACC, higher pressure drops require larger surface area equipment and higher performance of the fan motors, which then increases cost.

### Driving force for implementation

Electricity prices are a key driver.

Easier synchronisation of the TG set when the ambient temperature is high. [74, TWGComments, 2004]

### Example plants

Most of European plants got installation with ACC, e.g. Issy and Ivry plant, near Paris, and Bellegarde France; Southampton, UK (under construction). Both have open loop hydro-condensers.

Strasbourg, and Rouen, France -both have closed loop hydro-condensers with cooling towers.

---

6) Cooling tower or refrigeration tower. The steam condenser cooling fluid is water. This water is in a closed loop, and is cooled itself by contact with ambient air in a cooling tower. In this tower a part of the water is evaporated. This produces a water vapour plume above the tower.



**Reference literature**

[28, FEAD, 2002] [64, TWGComments, 2003]

**4.3.10 Selection of cooling system****Description**

Choosing the cooling system that is best suited to the local environmental conditions helps to reduce overall environmental impacts.

There are three main cooling systems:

**1. Water cooling by convection:**

This system uses surface water which is discharged to surface again after being heated up several degrees. This cooling system requires much water and gives a large thermal load to local surface water. It is mainly used if large flow rivers are available or on the coast. Noise level is low. Cleaning facilities for water are normally necessary, which may lead to harm to fish and other biota in water source as the water is screened/filtered. Care should be taken to reduce this in design of water intake arrangements. [74, TWGComments, 2004]

**2. Evaporation water cooling:**

Water is used for condenser cooling. This is not discharged, but recycled after passing an evaporation cooling tower, where it is cooled by the evaporation of a small part of the water. A small water stream must be discharged to keep control of the water quality within the system.

There are three main technical variants of evaporation cooling:

- forced draught cooling towers, where the air, required for evaporation of the water, is provided by means of a fan, with the subsequent electricity consumption
- natural convection cooling towers, where the draught of the air is caused by the (small) temperature increase of the air temperature (the large concrete cooling towers of 100 metres high) and
- hybrid cooling towers, where part of the heat in the water is transported to air by cooling bundles (“air cooling”), thus reducing the size of the water vapour plume.

Noise level of forced draught systems is high, and the level of convection draught systems is medium.

This type of cooler may involve a risk with respect to legionella, due to water evaporation and direct contact. [74, TWGComments, 2004]

**3. Air cooling:**

Here the steam is condensed in a heat exchanger of typical design (e.g. “camping tent model”) with air. These condensers use larger amounts of electricity, as the required air movement is caused by large fans.

Noise levels are higher. The surface of the condenser needs regular cleaning. [74, TWGComments, 2004]

Influence on electricity efficiency is dependent on water temperatures, air temperatures and air humidity (wet bulb temperature), but generally water convection cooling scores best, followed by evaporation cooling and then followed by air cooling. Difference in efficiency between convection cooling and air cooling is normally in the range of 2 – 3 %.

See also the BREF “Reference Document on the Application of Best Available Techniques to Industrial Cooling Systems”. [74, TWGComments, 2004]

### **Achieved environmental benefits**

Depending on type chosen (see description above) it is possible to:

- decrease installation parasitic electricity demand
- decrease thermal impacts of discharged warm water
- decrease noise impacts
- decrease visual impacts.

### **Cross-media effects**

Described in description above.

### **Operational data**

Information not supplied

### **Applicability**

Selection of cooling system dependent upon main local environmental and health issues and relative importance of cross-media effects associated with each system.

Water cooling by convection (type 1 above) is not applicable in dry inland situations.

### **Economics**

Information not supplied

### **Driving force for implementation**

Higher prices for electricity may encourage interest in convection cooling.

### **Example plants**

Issy and Ivry plant, near Paris, France; Southampton, UK (under construction). Both have open loop hydro-condensers.

Strasbourg, and Rouen, France -both have closed loop hydro-condensers with cooling towers.

### **Reference literature**

[64, TWGComments, 2003]

## **4.3.11 Optimisation of boiler architecture**

### **Description**

[28, FEAD, 2002]

The recovered heat is the energy that is transferred from the flue-gases to the steam (or hot water). The remaining energy of the flue-gas at the boiler exit is most commonly lost (unless heat-exchange systems are used further downstream). So, in order to maximise the energy recovery, it is usually favourable for the temperature of the flue-gases at the exit of the boiler to be reduced.

Boiler fouling has two effects on energy recovery. The first one is that it decreases the heat exchange coefficients and, therefore, leads to reduce the heat recovery. The second and major one is that it leads to blocking up the heat-exchange bundles and, therefore, to the shut down of the plant. Another unwanted effect of boiler fouling is that it increases the risk of corrosion under the deposited layer. In general, the boiler is designed for a manual cleaning once a year as a maximum to limit boiler fouling (see Section 4.3.19).

A good boiler must have a sufficient heat-exchange surface but also a well designed geometry in order to limit fouling. This can be achieved either in vertical, horizontal or combined vertical-horizontal boilers concepts (see Section 2.4.4.2.) [74, TWGComments, 2004] Examples of good design practices are reported as follows:

- gas velocities must be low (to avoid erosion) and homogeneous (to avoid high velocity areas and to avoid stagnation, which can induce fouling) over the whole diameter (space) of the boiler
- to maintain low gas velocities, the passes must be wide in cross-section and their geometry must be “aerodynamic”
- the first pass(es) of the boiler should not contain heat exchangers and have sufficient dimensions (especially height) in order to allow flue-gas temperature below 650 – 700 °C. However, they can be cooled by water walls (working by convection). (These tube walls, in fact, envelop the whole boiler except the economiser. In steam boilers, they are generally a part of the vaporiser). Radiating heat exchangers may also be placed in the open passes at higher temperatures
- the first tube bundles must not be installed at locations where the fly ashes are still sticky, i.e. where temperatures are too high
- the gaps between the tubes of the bundles must be wide enough to avoid “building” in between them (by fouling)
- water-steam circulation, in membrane wall and convective exchangers should be optimal in order to prevent hot spots, inefficient flue-gas cooling, etc.
- horizontal boiler should be designed in order to avoid flue-gas preferential path, leading to temperature stratification and ineffective heat exchange
- suitable devices for cleaning the boiler from fouling in situ should be provided
- optimisation of convective exchanger arrangement (counter-flow, co-current flow, etc.) in order to optimise the surface according to the tube wall temperature and prevent corrosion.

[74, TWGComments, 2004]

#### **Achieved environmental benefits**

Greater plant availability and better heat exchange allows increased overall energy recovery possibilities.

Design to reduce boiler fouling also reduces the retention of dust within temperature zones that may increase risk of dioxin formation.

#### **Cross-media effects**

None reported.

#### **Operational data**

No additional information supplied.

#### **Applicability**

Applicable at design stage to all incineration plants with energy recovery boilers, when concerns exist to improve the operating life and efficiency. [74, TWGComments, 2004]

#### **Economics**

Operational savings through reduced maintenance and increased energy sales can lead to very short payback periods, and can then justify the adoption of these techniques at new installations.

Existing plants that are going to replace boilers, or where lower boiler efficiencies are seen (generally less than 75 % heat transfer efficiency for municipal plants) may also take these factors into account in the design of the new system.

#### **Driving force for implementation**

Decreased maintenance, increased energy recovery and possible income from energy sales.

**Example plants**

Widely applied in Europe.

**Reference literature**

[28, FEAD, 2002], [2, infomil, 2002] [64, TWGComments, 2003]

**4.3.12 Use of an integral furnace - boiler**

**Description**

Transporting very hot gases in ducts lined with refractory can be complex. It can result in sticky and sometimes molten deposits. In order to avoid this, the gas temperature is sometimes reduced by increasing the air excess volume, which can result in a loss of efficiency.

In an integral furnace-boiler, the boiler directly covers the furnace without intermediate piping. Therefore, the boiler tube can cool the furnace sides. The tubes are protected by refractory and cool it (cross-benefit). A suitable design of the tubes and refractory allows fine control of the cooling of the furnace. Effective cooling of the furnace is essential to avoid clogging in the furnace, especially with higher LCV.

**Achieved environmental benefits**

Improves heat recovery by reducing the heat losses by radiation at the furnace outlet (to complement the effect of the external lagging).

Allows the installation of SNCR de-NO<sub>x</sub> systems.

Reduction in the excess air requirement and hence flue-gas volumes.

**Cross-media effects**

None reported.

**Operational data**

Avoids clogging in the furnace and, therefore, the need for shut downs for manual cleaning (e.g. with pneumatic drill).

**Applicability**

Suits all types of grates. Not applicable with rotary and oscillating kilns.

Indispensable for furnaces with a capacity above 10 t/h of waste.

No known lower capacity limit for integral boilers in “industrial” incinerators, i.e. capacity above 2.5 t/h.

**Economics**

Usually less expensive than a separate boiler for plants above very small capacity furnaces (i.e. 1 or 2 t/h)

**Driving force for implementation**

Normal practice for designers today.

**Example plants**

Most modern plants have an integral boiler-furnace (except rotary and oscillating kilns).

**Reference literature**

[28, FEAD, 2002] [64, TWGComments, 2003]

### 4.3.13 Use of water walls in the first (empty) pass

This technique has been described in Section 4.2.22 in the context of its benefit as a combustion related technique.

### 4.3.14 Use of a platten type superheater

#### Description

Platten type superheaters are flat panels of folded tubes installed in parallel with wide gaps in between and parallel to the gas flow. The inlet is protected by shells made of stainless steel, held in place with special cement.

The heat exchange is made by radiation instead of convection; because of this, these superheaters can be installed at hotter locations than the tube bundles (in flue-gases up to 800 °C on municipal waste), with limited fouling and reduced erosion and corrosion.

On these platten superheaters, fouling can stabilise when its thickness is around 2 cm. There is no blocking, therefore, manual cleaning and associated shutdowns are greatly reduced.

Due to radiation exchange, the steam temperature can remain constant over a period of time of one year of operation. Erosion and corrosion are significantly delayed.

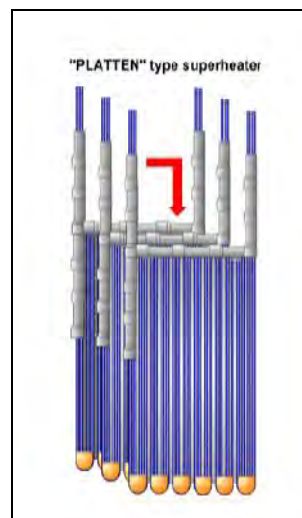

Figure 4.3: Schematic diagram of a “platten” type superheater

#### Achieved environmental benefits

These platten type superheaters allow high superheated steam temperature with good availability and stability.

#### Cross-media effects

None reported.

#### Operational data

Information not supplied.

#### Applicability

It can be installed in any boiler with two or three open passes.

### **Economics**

Less expensive than bundles for last stage superheaters (the hotter ones) when installed in areas with hotter flue-gas temperatures (2nd or 3rd pass).

Use may increase construction cost and this needs to be considered against the additional heat exchanger life that may be gained.

### **Driving force for implementation**

Longer operation period with high superheated steam temperature

### **Example plants**

- France: Toulon 3, Thiverval 3, Lons le saunier, Cergy St Ouen l'Aumône, Rennes 3, Monthyon, Chaumont, Nice 4, Belfort, Villefranche sur Saône, Toulouse-Mirail 1 and 2, Lasse (Saumur)
- Belgium: Thumaide
- UK: London SELCHP, Stoke-on-Trent, Dudley, Wolverhampton, Chineham, Marchwood
- Spain: Mataró
- Portugal: Maia, Loures and Santa Cruz (Madeira)
- Italy: Piacenza
- Russia: Moscow.

### **Reference literature**

[28, FEAD, 2002] [64, TWGComments, 2003]

## **4.3.15 Reduction of flue-gas temperatures after the boiler**

### **Description**

[2, infomil, 2002]

Additional heat-exchange capacity in the boiler can improve possibilities for use of that heat elsewhere and, hence, can contribute to improved energy efficiency. How much the flue-gas temperature at the end of the boiler can be reduced depends on:

- at temperature levels below 180 °C there is an increased risk of corrosion (as the dew point of the various acids is progressively approached).
- whether the heat in the flue-gases is required for the operation of subsequent flue-gas cleaning equipment
- whether there is a beneficial use for the additional heat recovered at low temperature.

With MSW (and other flue-gases containing these substances) flue-gases the corrosion risks arises not only from HCl but from the SO<sub>x</sub>, which are often the first to attack steel. The dew point depends on the concentrations of the acid gases in the flue-gases. In clean gas it can be around 100 °C, in raw gas 130 °C or more.

The key temperature to consider in term of corrosion risk is not the temperature of the flue-gas but the (lower) surface temperature of the (cooled) metal tubes of the exchanger (which is necessarily colder than the flue-gas). [74, TWGComments, 2004]

Heat-exchangers, which are made of special materials (enamel, carbon) reduce low temperature corrosion problems. An example is found at AVI Amsterdam, where a heat-exchanger is located after the spray absorber system and the related ESP. An additional advantage of this, is the related reduction of scrubbing temperature, which improves the efficiency of the scrubbing system.

**Achieved environmental benefits**

The recovered heat (temperature level e.g. 120 °C) can be used for heating purposes and/or internally for preheating of the boiler feed-water, etc.

**Cross-media effects**

With flue-gas cleaning systems that require the flue-gases to be above a particular operational temperature (e.g. bag filters, SCR) any heat removed will need to be re-added by some means later in the process. Such reheating is likely to result in additional consumption of primary fuels or external power.

Low outlet gas temperature at the boiler outlet involves risks of corrosion (internal and external). Then specific material protection etc. can be required.

Space requirement may limit the implementation in existing plants.

**Operational data**

[28, FEAD, 2002]

Lowering the flue-gas temperature at the boiler outlet is limited by the acid dew point, which is a very important limitation in many FGT systems. In addition, the flue-gas cleaning system may require a working temperature or a temperature difference, for example:

- with semi-wet FGT processes, the minimum temperature at the inlet is determined by the fact that the water injection decreases the temperature of the gases. Typically, it will be 190 or 200 °C, and can be higher
- a dry FGT process can generally accept 130 - 300 °C. With dry sodium bicarbonate the minimum required temperature is 170 °C to obtain a fast transformation of sodium bicarbonate into higher surface area and, hence, more efficient sodium carbonate (the so-called “pop-corn” or “diatomite” effect). The consumption of reagent is different according to the temperature
- Wet FGT systems do not have a theoretical minimum inlet temperature - the lower the gas temperature at the scrubber inlet, the lower the water consumption of the scrubber.

[74, TWGComments, 2004]

It is possible to design the cycle in such a manner to avoid the corrosion conditions. In Sweden, for example, it is quite common to install a separate "waste heat boiler" after the main boiler or ESP. It is often cooled by a separate hot water circuit and by a heat exchanger to the district heating net. Outlet flue-gas temperature is normally about 130 – 140 °C and water inlet temperature should not be under 115 – 120 °C to avoid corrosion. At these temperature levels normal carbon steel tubes can be used without corrosion problems. [64, TWGComments, 2003]

**Applicability**

Reducing the flue-gas temperature after the boiler is only applicable where:

- the heat extracted can be supplied and put to some useful purpose
- subsequent flue-gas cleaning systems are not adversely effected.

Careful consideration must be given to compatibility of this technique with subsequent flue-gas cleaning systems. Particularly where bag filters, SCR or other systems that require particular operational temperatures or conditions, are used.

**Economics**

The system is most likely to be economically viable where the value/price paid for the additional heat recovered heat is high.

**Driving force for implementation**

Supply of additional heat recovered.

**Example plants**

- AVI Amsterdam, Netherlands.
- Brescia, Italy.
- Many plants in Sweden and Denmark.
- Sheffield (UK)
- Rennes, Nice, St. Ouen (France)
- Monaco

**Reference literature**

[2, infomil, 2002] [64, TWGComments, 2003]

**4.3.16 Use of flue-gas condensation scrubbers**

**Description**

The technique has already been described in Section 2.4.4.5.

In summary, the technique involves the use of a cooled scrubber that condenses water vapour from the flue-gas of wet, semidry and dry systems normally as tail end solution. The cooling can be provided by heat exchange (using a heat pump system) with the returned district heating water.

**Achieved environmental benefits**

The use of condensing scrubbers allows the extraction of additional energy from the flue-gases for possible use or supply.

The amount of additional energy recovered is dependent upon the return water temperature in the district heating system:

District heating return temperature (°C)	Additional energy efficiency
40	14 %
50	7 %
60	0 %

**Table 4.19: Relationship between the additional energy efficiency and the cooling medium (district heating) return temperature**  
[5, RVF, 2002]

The drying effect on the flue-gases reduces the plume visibility. Where energy is used to reheat the plume, the amount of energy required to achieve a given reduction in plume visibility will be lower.

Emissions of ammonia to air (e.g. from SNCR) may be reduced. The ammonia is captured in the scrubber water. By using an ammonia stripper at the water treatment plant, it is possible to regenerate ammonia for use as a NO<sub>x</sub> reduction reagent - thus replacing the need to purchase new ammonia, although stripping systems are reported to be complex and expensive.

The condensed water can be used to provide the majority of the scrubber feed water, therefore reducing water consumption.

**Cross-media effects**

The condensed water will contain pollutants (removed from the flue-gas) that require treatment in a water treatment facility prior to discharge. Where an upstream wet scrubbing system is applied, the effluent from the condensing scrubber can be treated in the same facility.



The low temperature of the stack discharge will reduce thermal buoyancy of the plume and, hence, reduce dispersion. This can be overcome by using a taller and/or reduced diameter stack.

### **Operational data**

The low temperature of the flue-gases can result in condensation and, hence, corrosion in the chimney unless lined or double tube systems are used.

### **Applicability**

Most applicable where:

- district heating gives a reliable low temperature return (this is essential and generally only available in colder climates)
- plume visibility is a concern
- prices paid for the additional energy recovered justify the additional capital investment.

The technique is less applicable where:

- there is no user for the additional energy recovered
- the cooling source (DH cold water return) is less reliable (i.e. warmer climates).

Waste types:

Because the technique is applied after the flue-gas cleaning stages, in principle the technique could be applied to any waste type.

Plant size:

The technique is known to have been applied at municipal plants of 37000 (DK), 175000 (S) and 400000 (S) tonnes per year throughput.

New/existing:

The technique is applied at/near the end of the FGT system and could, therefore, be applied to new and existing processes alike.

### **Economics**

The total additional investment for the condensation stage is roughly estimated to EUR 3 million for four boilers serving a MSWI CHP plant of capacity 400kt/yr.

### **Driving force for implementation**

Additional heat sales. Water conservation in dry regions. [74, TWGComments, 2004]

### **Example plants**

There are several examples in Sweden (see examples in Section 2.4.4.5). Possibilities are fewer in warmer climates owing to reduced availability of cool DH water return.

### **Reference literature**

[5, RVF, 2002], [64, TWGComments, 2003]

## **4.3.17 Use of heat pumps to increase heat recovery**

### **Description**

The technique has already been described in some detail in Section 2.4.4.6. The three main types of heat pumps are also described there.

In summary, heat pumps provide a means of uniting various relatively low temperature heat and cooling sources to provide a stream at an upgraded temperature level. This allows, for example, the operation of condensing scrubbers (see 4.3.16) and the supply of the additional heat to users.

### Achieved environmental benefits

Enables the recovery of additional energy by the use of condensing scrubbers.

An increase in the quantity of energy recovered of 23 % was reported when using absorption heat pumps in combination with condensing scrubbers. [35, Renova, 2002]

Based on the example of the Umea plant in Northern Sweden (175 Kt/yr) the following estimated energy balance is seen:

The power balance including condensation and compressor heat pump:

Thermal power input, about	65 MW
Electricity output from generator	15.1 MW
Internal electricity consumption	5.4 MW
Electricity output, net	9.7 MW
Hot water generation incl. cond.+ heat pump	54 MW
Own consumption for reheat	0.5 MW
Hot water to district heat	<u>53.5 MW</u>
<b>Total power and heat for sale</b>	<b><u>63 MW</u></b>

Without FG condensation and heat pumps the power balance is estimated as:

Thermal power input about	65 MW
Electricity output, net	13 MW
Hot water to district heating, net	<u>39 MW</u>
<b>Total power and heat for sale</b>	<b><u>52 MW</u></b>

### Cross-media effects

The heat pumps themselves require energy to function.

At wet ESP conditions, for compressor driven heat pumps, the ratio between output heat and compressor power (heat to power ratio) can be about five [5, RVF, 2002].

### Operational data

See detailed information given in Section 2.4.4.6.

### Applicability

Most applicable where:

- district heating gives a reliable low temperature return
- district heating uses most of the available heat
- prices paid for the additional energy recovered justify the additional capital investment
- wet scrubbing is used
- plume visibility is a concern.

[74, TWGComments, 2004]

The technique is less applicable where there is no user for the additional energy recovered.

Waste types:

Because the technique is applied after the flue-gas cleaning stages, in principle the technique could be applied to any waste type.

Plant size:

The technique is known to have been applied at municipal plants of 175000 and 400000 tonnes per year throughput.

New/existing:

The technique is applied at/near the end of the FGT system and could therefore be applied to new and existing processes alike.

### **Economics**

Heat pumps example for an MSWI in Sweden [35, Renova, 2002]:

- EUR 4.5 million installation in 1988
- EUR 5.5 million installation 2002 (12 MW capacity)
- income since 1998 = EUR 24.5 million.

The additional investment at the Umea plant for the condensation stage + electric motor driven compressor heat pump + bigger water treatment is estimated to EUR 4 million. Using the proceeds for heat and power as given in Table 10.9, the simple pay back time for this investment is therefore about 2.4 years (no allowance for increased maintenance and consumables).

### **Driving force for implementation**

Additional heat sales and income.

### **Example plants**

Several examples in Sweden – see also Section 2.4.4.6

### **Reference literature**

[5, RVF, 2002] [64, TWGComments, 2003]

## **4.3.18 Special configurations of the water/steam cycle with external power plants**

### **Description**

[2, infomil, 2002]

Due to the corrosive nature of the flue-gases, the efficiency of electricity production of municipal waste incineration is limited by the maximum acceptable temperature of the boiler tube materials and by the related maximum steam temperature.

Without the use of special materials to protect boiler tubes from corrosion, steam parameters in municipal waste incineration plants are generally less than or equal to 40 bar and 400 °C. In hazardous waste plants (where chloride etc. loading in the raw gas is higher) lower temperatures and pressures (e.g. 30 bar and 280 °C) are used to avoid excessive corrosion rates and consequent high maintenance costs. The adoption of higher steam parameters allows more heat to be transferred to the medium at higher temperature. The thermodynamic efficiency is, therefore, increased and hence the electrical output per tonne of waste. However, the costs of the materials required to protect the boiler tubes is generally significant in relation to the income to be received from the additional electricity sales (see Section 4.3.8).

An option that avoids higher temperatures of boiler tube materials, is the superheating of the steam using cleaned flue-gases, which contain much less or no chlorine. This is possible if the municipal waste incineration plant can be combined with a power plant of sufficient capacity.

Example: Municipal waste incineration plant, AZN Moerdijk, NL

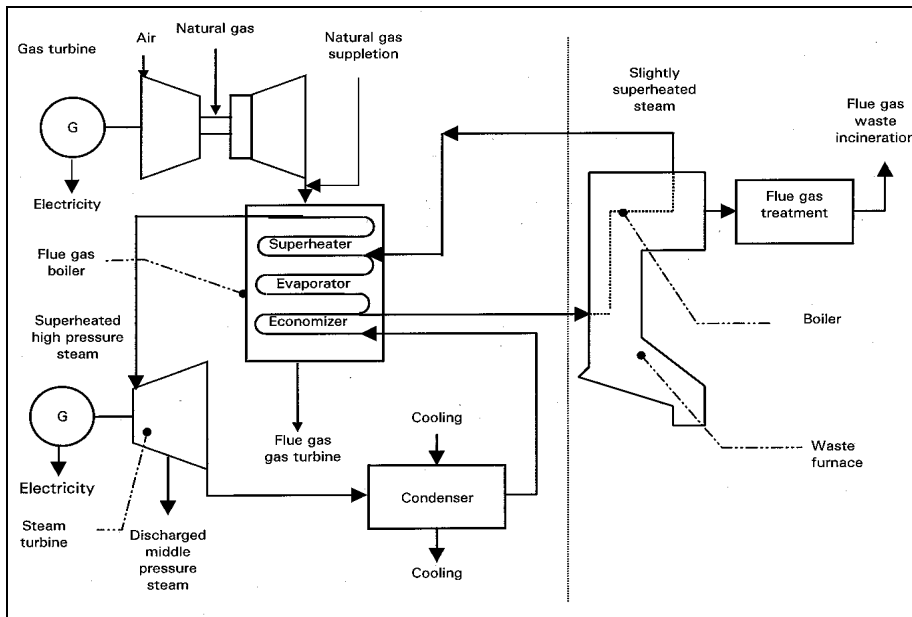

**Figure 4.4: Combination of a waste incineration plant with a gas turbine power plant [2, infomil, 2002]**

This waste incineration plant is combined with an adjacent combined cycle natural gas power plant, as indicated above. Steam at 100 bar, slightly superheated to 400 °C is supplied to the waste heat boilers of the gas turbine plant, where it is superheated to approximately 545 °C.

Both the municipal waste incineration plant and the gas power plant have three separate lines. The design of both plants combined process schemes enables all incineration and gas turbine lines to operate independently, although, under these circumstances, at a lower energy efficiency.

Example:

A similar configuration can be used in the combination of a waste incineration plant with a coal power plant. The coal power plant superheats the steam of the municipal incineration plant. In order to do this, the pressure of the steam produced by the municipal waste incineration plant has to be higher than usual.

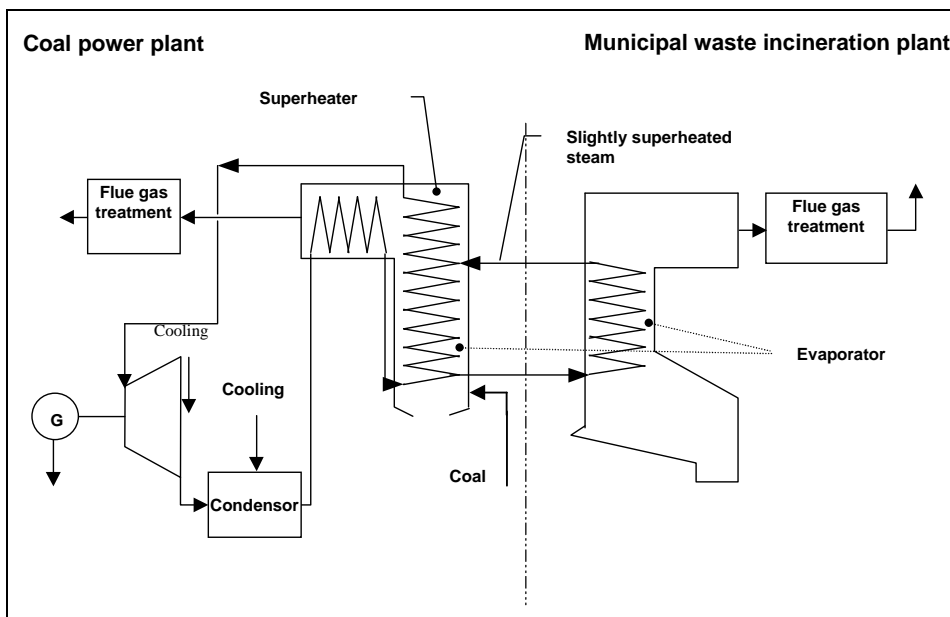

**Figure 4.5: Municipal waste incineration plant in combination with a coal power plant Source [2, infomil, 2002]**

This configuration was applied in the 1970s, by the combination of a municipal waste incineration plant in Munich with a large coal power plant. As the plant only functioned effectively when both the coal-fired boiler and waste incineration plant were operational simultaneously, the combination was not considered cost effective at the time.

**Achieved environmental benefits**

Improved overall energy efficiency by supply of heat to a synergistic user.

**Cross-media effects**

None reported.

**Operational data**

With these types of configurations, the incineration process does not need to adopt high steam temperatures and therefore avoids corrosion and availability difficulties. However, sometimes the pressure may be increased in order to benefit further from the integration. In such cases the higher steam temperature in the evaporator may lead to additional maintenance costs. For instance, at 40 bar the saturation temperature is 250 °C and at 100 bar 311 °C, a difference of 61 °C. Note that corrosion mechanisms increase exponentially with the external temperature on the boiler tube walls when coming into contact with flue-gases.

**Applicability**

Only applicable where a synergistic operation is situated conveniently and suitable commercial agreements are in place.

Mainly applicable where the focus of energy recovery is the production of electricity. Less applicable to plants that can supply steam or heat directly to a user.

Energy efficiency will only be increased where the user has a consistent demand and makes consistent use of the energy supplied.

**Economics**

High electricity prices encourage the adoption of techniques that increase electrical generation efficiency. In this case, this has the impact of increasing the relative value of the steam/heat supplied by the incinerator to the adjacent power plant.

**Driving force for implementation**

Integration of energy supply with an external user increases options for the use of energy derived from the waste.

**Example plants**

See text above. Also Bilbao Zabalgardi, ES.

Another waste incineration plant where steam is introduced in the water-steam cycle of an adjacent power plant is located in Austria. [74, TWGComments, 2004]

**Reference literature**

[28, FEAD, 2002], [2, infomil, 2002] [64, TWGComments, 2003] [74, TWGComments, 2004]

### 4.3.19 Efficient cleaning of the convection bundles

**Description**

[2, infomil, 2002]

Clean boiler tubes and other heat-exchange surfaces result in better heat exchange. This may also reduce the risk of dioxin formation in the boiler.

Cleaning may be carried out on-line (during boiler operation) and off-line (during boiler shut downs and maintenance periods). Dimensions of the boiler and heat exchanger design (e.g. tube spacings) influence the cleaning regime.

Techniques for on-line cleaning include:

- mechanical rapping
- soot-blowing by steam injection
- high or low pressure water spraying (mainly on the wall in the empty passes of the boiler)
- ultra-/infra- sonic cleaning
- shot cleaning or mechanical pellet scouring
- explosive cleaning
- high pressured air injection (from 10 to 12 bar) with movable lances.

[74, TWGComments, 2004]

Off-line techniques include:

- periodic manual cleaning (in general once a year in MSWI)
- chemical cleaning.

[74, TWGComments, 2004]

In addition to these techniques, it can also be beneficial to prevent higher temperature (above 650 °C) gases (when fly ashes are more sticky and hence more likely to adhere to surfaces they come into contact with) coming into contact with convective heat-exchange bundles by:

- including empty passes with water walls only
- using large furnace dimensions and hence lower gas velocities before the bundles.

### **Achieved environmental benefits**

Improved heat-exchange increases energy recovery.

Although FGT systems can be used to absorb or destroy PCDD/F, the reformation risk may be reduced by effective cleaning. This is because it reduces the amount of time that dusts (and other materials that can promote their formation) are present at temperatures of between 450 and 250 °C - where reaction rates are at their highest.

By soot-blowing with self-produced steam injection most of the energy will be recovered by the boiler itself (80 – 90 %). [74, TWGComments, 2004]

### **Cross-media effects**

Consumption of the soot-blowing agent e.g. high pressure water, low pressure water, steam (only partially).

Noise may be an issue with some of the techniques e.g. explosive cleaning, mechanical rapping.

### **Operational data**

Those techniques that allow continuous on-line tube cleaning (normally operated once per 8 hours shift) normally have reduced downtime for boiler maintenance cleaning operations.

[74, TWGComments, 2004]

Usually manual cleaning is done when fouling has induced a flue-gas temperature increase of 20 to 50 °C, i.e. 1.5 to 3 % decrease in energy efficiency.

Potential mechanical damage of the boiler structure/tubes can occur, particularly with explosive cleaning and mechanical rapping.

Tube erosion can lead to decreasing energy efficiency and eventually tubes will require replacement.

### **Applicability**

All waste incinerators with boilers.

### **Economics**

No data supplied.

### **Driving force for implementation**

Improved availability and heat recovery, reduced corrosion, emissions, and energy consumption. [74, TWGComments, 2004]

### **Example plants**

All waste to energy plants. [74, TWGComments, 2004]

Specific cleaning system in several plants in NL and DK e.g. AVI ARN Beuningen (explosive cleaning with gas), AVI Amsterdam and AVI Wijster (explosive cleaning with dynamite). [74, TWGComments, 2004]

### **Reference literature**

[2, infomil, 2002] p 51 – 52, [1, UBA, 2001] p 119, [64, TWGComments, 2003]

## **4.4 Flue-gas treatment**

### **4.4.1 Factors to consider when selecting flue-gas treatment systems**

#### **4.4.1.1 General factors**

[54, dechefdebien, 2003]

The following (non-exhaustive) list of general factors requires consideration when selecting flue-gas cleaning (FGT) systems:

- type of waste, its composition and variation
- type of combustion process, and its size
- flue-gas flow and temperature
- flue-gas content, size and rate of fluctuations in composition
- target emission limit values
- restrictions on discharge of aqueous effluents
- plume visibility requirements
- land and space availability
- availability and cost of outlets for residues accumulated/recovered
- compatibility with any existing process components (existing plants)
- availability and cost of water and other reagents
- energy supply possibilities (e.g. supply of heat from condensing scrubbers)
- availability of subsidies for exported energy
- tolerable disposal charge for the incoming waste (both market and political factors exist).
- reduction of emissions by primary methods
- release of noise
- arrange different flue-gas cleaning devices if possible with decreasing flue-gas temperatures from boiler to stack.

[74, TWGComments, 2004]

### 4.4.1.2 Energy optimisation

Some flue-gas treatment techniques can add significantly to the overall energy requirements of the incineration process. It is necessary to consider the additional energy requirements imposed by applying lower ELVs. The following key observations can be made:

- reducing dust emissions including boiler ash (and metals filtered with dust) generally requires additional filtration and increases energy consumption
- reducing NO<sub>x</sub> emissions to below 100 mg/m<sup>3</sup> is most often achieved using SCR - which, because it is typically only used as a low dust system in waste incineration, is situated at the clean gas end of the FGT system. It therefore usually requires some additional energy for flue-gas reheating. Very low SO<sub>x</sub> levels in the raw flue-gas may allow SCR to be used without reheat (see 2.5.5.2.2). The energy required for the operation of additional flue-gas cleaning (to meet very low ELVs) if supplied from that generated by the incinerator, will result in a reduction of that available for export
- boiler exit temperature has a key influence on FGT energy requirements – if below the acid dew point additional energy input will be required to heat the flue-gas
- in general, placing the FGT components so that those requiring the highest operational temperatures, precede those that operate at lower temperatures, results in lower overall FGT energy demand (but this cannot be achieved in some cases e.g. SCR generally requires clean gas and must, therefore, be placed after the lower temperature gas cleaning stages).  
[64, TWGComments, 2003] [74, TWGComments, 2004]

### 4.4.1.3 Overall optimisation and the “whole system” approach

As well as considering the energy aspects (see sections on energy above), there is benefit from considering the FGT system as a whole unit. This is particularly relevant to the removal of pollutants because the units often interact, providing a primary abatement for some pollutants, and an additional effect on others. Depending on the position in the cleaning sequence different cleaning efficiency values are obtained. [74, TWGComments, 2004] Multifunctional devices are common, for example:

- if a Bag-House Filter (BF), is used downstream of reagent injection, in addition to its dusting effect, it acts as a complementary reactor. The pressure drop through the fabric material distributes the flue-gas on the adhered cake which contains some deposited reagent and, due to the low velocity of the gases, the residence time is long. A BF can, therefore, contribute to the treatment of acid gases, gaseous metals such as Hg and Cd, and POPs (Persistent Organic Pollutants) such as PAH, PCB, dioxins and furans
- in addition to acid gas treatment, wet scrubbers can help with the capture of some particulate and, if the pH is low enough or with the use of scrubber reagents, of Hg
- SCR de-NO<sub>x</sub> has an additional destruction effect on dioxins if designed (sized) accordingly
- the adsorption by activated carbon and lignite coke has an effect on dioxins as well as on Hg and other substances.

[64, TWGComments, 2003] [54, dechefdebien, 2003]

### 4.4.1.4 Technique selection for existing or new installations

Overall optimisation and the interface between FGT systems components (as well as the rest of the incineration process) is important for both new and existing installations. With existing installations the number of options may be more severely restricted than with new installations. Comments regarding inter-process compatibility may be found in the sections that deal with individual FGT techniques.



## 4.4.2 Reduction of dust emissions

The application of a system to remove dust from the flue-gas is generally considered essential for all waste incineration installations. This section considers the locating of a dust removal stage before other subsequent FGT stages (i.e. *pre-dedusting*) or after other FGT systems as a final flue-gas polishing system. In some cases double filtration is applied, this is also considered in this section.

### 4.4.2.1 Application of a pre-dedusting stage before other flue-gas treatments

#### Description

This section considers the locating of a dust removal stage, generally after pre-dedusting in the boiler stage, [74, TWGComments, 2004] but before other subsequent FGT stages.

The following pre-dedusting systems are used for waste incineration:

- cyclones and multi-cyclones
- electrostatic precipitators (ESPs)
- bag filters (BFs).

The individual techniques themselves have already been described in Section 2.5.3

#### Achieved environmental benefits

Reduction of emissions to flue-gas stream by reducing particulate load on later FGT processes.

Separation of the fly ash from the FGT residues allows:

- reductions in the quantity of FGT residues produced
- separate treatment of fly ashes for possible re-cycling uses.

Separate collection of the flue-gas components will not be of any environmental benefit if the separated residues are then re-mixed afterwards. Consideration of downstream aspects is therefore required to evaluate the possibility of real benefits. [64, TWGComments, 2003]

ESPs and cyclones may have problems reaching the lower of the generally applied dust emission standards on their own. However, they are useful as pre-dedusters and contribute to meeting the lowest of emission levels when applied in combination with other techniques.

[2, infomil, 2002] Cyclone collection efficiency increases directly as a function of the dust load, flue-gas-flowrate, particle size and density. As the fly ash particles are fine, the density is low and the dust load and flue-gas flowrate changes, so the dust removal efficiency of cyclones is limited. Normally dust concentration values no lower than 200 – 300 mg/m<sup>3</sup> can be reached. Multi-cyclones, which are based on the same removal principle, can reach somewhat lower values, but values below 100 – 150 mg/m<sup>3</sup> are very difficult to achieve.

[2, infomil, 2002] An ESP can reach substantially lower dust concentration values than (multi-) cyclones. Depending on the design and the siting in the flue-gas treatment system (pre- or end-dedusting), and the number of fields, dust emission concentration values of 15 to 25 mg/m<sup>3</sup> can normally be achieved. Achieving values below 5 mg/m<sup>3</sup> are possible with larger numbers of fields (2 or 3) and increased ESP surface (and hence increased cost and space requirement for implementation).

A specific version of the ESP is the **wet ESP**. This is not generally applied to pre-dedusting on account of the flue-gas temperatures in that area. [64, TWGComments, 2003] in general it is more used for polishing after scrubbing. [74, TWGComments, 2004]

Bag filters are generally very efficient dust removers. Where bag filters are used, most commonly reagents are also injected (although this is not always the case) to build pre-coat layer over the bags to protect from corrosion and help filtration (especially for in-depth filtration). [74, TWGComments, 2004] The reagents used are commonly lime and activated carbon. The presence of the activated carbon reduces the dioxin loads passing on to the subsequent flue-gas cleaning stages. For wet systems this helps to reduce memory effect dioxin build up in the scrubber materials.

### Cross-media effects

Cross-media effects are identified in the table below with available data:

Criteria	Units	Value	Comments
<b>Energy requirements:</b>	kWh/tonne waste input		
<b>Cyclone</b>		Low	lower efficiency for removal of particles of sizes <5 micrometers.
<b>Multi-cyclone</b>		Low	
<b>Dry ESP</b>		Higher (electrostatic loading)	Common technology
<b>Wet ESP</b>		Higher (pressure drop)	
<b>Bag filter</b>		Highest by pressure drop and pulsing high pressure air cleaning	Common technology
<b>Residue - type</b>		Fly ash	Separate collection of fly ash from main chemical pollutants possible if not operated with reagents
<b>Residue - amount</b>	kg/t waste input	12 – 20 (<50)	Without reagents (with reagents)
<b>Water consumption</b>	l/t waste input		<ul style="list-style-type: none"> <li>for wet ESP</li> <li>for gas cooling prior to bag filters</li> </ul>
<b>Effluent production</b>	l/t waste input		<ul style="list-style-type: none"> <li>wet ESP effluent</li> </ul>
<b>Plume visibility</b>	yes/no	yes	<ul style="list-style-type: none"> <li>wet ESP highest visible plume</li> </ul>

**Table 4.20: Cross-media effects associated with the use of various pre-dedusters**  
[74, TWGComments, 2004]

For this technique the most significant cross-media effects are:

- energy consumption of bag filters is higher than other systems due to higher pressure loss
- ESP requires electricity for its operation
- generation of fly ash from the gas cleaning
- flue-gas PCDD/F-concentrations may increase during their residence time in the ESP, particularly when operated at temperatures above 200 to 450 °C
- the FGT residues and fly ash can be separated using this pre-dedusting technique.

### Operational data

Pre-dedusting reduces dust loads on subsequent FGT systems. These may then be reduced in capacity, experience reduced clogging risks, and hence downstream units may be designed smaller and with some degree of reduced costs.

Care should be taken concerning the level of ash in the hopper as well as cinder (especially if bag filters are implemented directly after the boiler) to prevent risk of fire.

[2, infomil, 2002] Cyclones are a relatively simple design without moving parts (except for the transport systems used for the removal of the fly ash from the bottom) and, therefore, can have high availability at relatively low costs. However, the pressure drop of the flue-gas stream is relatively high, resulting in an increased power requirement for the flue-gas fan and therefore in additional energy consumption.

[2, infomil, 2002] For the proper functioning of an ESP, it is important that the flue-gas stream is evenly distributed over its total surface. The pressure drop of the flue-gas over an ESP is low, reducing energy consumption. However some pre-dedusting equipment (e.g. ESPs, filters) require electricity for their operation.. [74, TWGComments, 2004] Further information on ESP systems can be found in Chapter 2.5.3.

ESPs can be divided into multiple compartments (usually 1 – 4 successive fields), each with their own electrical system. This gives the advantage that, even during a breakdown of one of the electrical systems (e.g. short-circuit by dust clogging or broken high voltage wires), [74, TWGComments, 2004] a relatively large part of the dust removal capacity is still available.

Bag filters are often divided in compartments that may be isolated for maintenance purposes, an even flue-gas distribution is important for optimal performance.

Criteria	Description of factors affecting criteria	Evaluation (High/Medium/Low) or data	Comment
<b>Complexity</b>	<ul style="list-style-type: none"> <li>additional process units required</li> <li>critical operational aspects</li> </ul>	M	The extra process units adds complexity, but can simplify later operations.
<b>Flexibility</b>	<ul style="list-style-type: none"> <li>ability of technique to operate under range of input conditions</li> </ul>	H	Each of the systems can be applied to variable flue-gas flows and composition
<b>Skill requirements</b>	<ul style="list-style-type: none"> <li>notable extra training or manning requirements</li> </ul>	H/M	Bag filters require the most attention, and cyclones the least. ESPs in between.
<b>Other requirements</b>	<ul style="list-style-type: none"> <li>Bag filters may require addition of reagents for corrosion and fire protection</li> </ul>		

**Table 4.21: Operational data associated with the use of pre-dedusting systems**

The table below provides a comparison of the various dust removal systems (used at the pre and post de-dusting stages):

Dust removal systems	Typical emission concentrations	Advantages	Disadvantages
Cyclone and multicyclone	- cyclones: 200 – 300 mg/m <sup>3</sup> ; - multicyclones: 100 – 150 mg/m <sup>3</sup> .	- robust, relatively simple and reliable. - applied in waste incineration.	- only for pre-dedusting - relatively high energy consumption (compared to ESP)
ESP - dry:	<5 – 25 mg/m <sup>3</sup>	- relatively low power requirements. - can use gas temperatures in the range of 150 – 350 °C - widely applied in waste incineration.	- formation of PCDD/F risk if used in range 450 - 200 °C
ESP- wet:	<5 – 20 mg/m <sup>3</sup>	- able to reach low emission concentrations - sometimes applied in waste incineration	- little experience in waste incineration - mainly applied post-dedusting - generation of process waste water - increase of plume visibility
Bag filter	<5 mg/m <sup>3</sup> .	- widely applied in waste incineration - the layer of residue acts as an additional filter and as an adsorption reactor	- relatively high energy consumption (compared to ESP) - sensitive to condensation of water and to corrosion

**Table 4.22: A comparison of dust removal systems**  
[2, infomil, 2002]

### Applicability

The applicability of the pre-dedusting technique is assessed in the following table:

Criteria	Evaluation/Comment
Waste type	<ul style="list-style-type: none"> <li>• applicable to all waste types</li> <li>• may not be required for low raw gas dust concentrations</li> </ul>
Plant size range	<ul style="list-style-type: none"> <li>• no restriction</li> </ul>
New/existing	<ul style="list-style-type: none"> <li>• space may be a factor for existing plants</li> </ul>
Inter-process compatibility	<ul style="list-style-type: none"> <li>• greater temperature control required for bag filter</li> </ul>
Key location factors	<ul style="list-style-type: none"> <li>• space required for additional process unit</li> </ul>

**Table 4.23: Assessment of the applicability of pre-dedusting**

### Economics

The key aspects of this technique are:

- increased capital and investment costs - for additional process units
- increased energy costs particularly for bag filtration
- possible cost reductions for disposal where outlets are available for segregated fly ash
- possible increased cost of handling additional residue streams (either for recovery or disposal).

Investment costs for a two line MSWI of total capacity 200000 t/yr are estimated as [12, Achternbosch, 2002]:

- ESP (3 field)            EUR 2.2 million
- ESP (2 field)            EUR 1.6 million
- fabric filter             EUR 2.2 million (not clear if this includes an upstream flue-gas cooler).

The unit operational costs of a bag filter for pre-dedusting may be higher due to the higher energy use associated with the pressure drop and the reagent injection. However, the greater dust and the other pollutant removal capacity of bag filters (particularly when used with reagent injection) can result in reduced costs for subsequent components of the FGT system.

#### **Driving force for implementation**

This technique has been implemented where:

- the fly ash removed can be treated and recycled
- smaller capacity downstream FGT equipment is required (requirement for dust loads are reduced)
- improvements in the operation of downstream FGT systems
- there exists a preference for the removal of PCDD/F before wet scrubbing to reduce memory effects.

#### **Example plants**

Widely applied technique in many incineration plants.

#### **Reference literature**

[2, infomil, 2002], [55, EIPPCBsitevisits, 2002] [64, TWGComments, 2003]

### **4.4.2.2 Application of an additional flue-gas polishing system**

#### **Description**

This technique relates to the application of flue-gas polishing systems for the final reduction of dust emissions after other FGT has been applied, but before the final release of stack gases to the atmosphere. The main systems applied are:

- bag filters
- wet-ESP
- electrodynamic venture scrubbers
- aggro-filtering modules
- ionizing wet scrubber.

[74, TWGComments, 2004]

Also, it is possible to consider that the addition of a final wet flue-gas treatment system is a polishing treatment after other systems that deal with acid gases etc. This addition is generally made to specifically control HCl emissions where they are highly variable. This additional treatment is considered in Section 4.4.3.6. [64, TWGComments, 2003]

The main technical components have already been described in Section 2.5.3

Polishing devices are also implemented to remove droplets (especially fine ones). They are generally implemented to prevent fouling in downstream devices such as SCR. [74, TWGComments, 2004]

### Achieved environmental benefits

Further reduction of emissions to air beyond that already achieved by other FGT components are as follows:

Substance(s)	Reduction efficiency range (%)	Achievable emission ranges				Comments
		½ hour average mg/Nm <sup>3</sup>	daily average mg/Nm <sup>3</sup>	annual average mg/Nm <sup>3</sup>	specific emission (g/tonne waste input)	
Dust		<30	0.04 – 5	<0.5		
Note: the precise final emission level realised will depend on the inlet level to the final dust removal stage (itself depending on the performance of the earlier stages applied) and the efficiency of the final dust removal stage used. The figures given here provide a guide to the sort of emission levels that are generally seen where a polishing stage is added.						

**Table 4.24: Emission levels associated with the use of BF flue-gas polishing systems**  
[2, infomil, 2002], [1, UBA, 2001]

In addition to reduction of dusts, emissions to air of the following substances can also be reduced:

- heavy metals - as their emission concentrations are usually associated with dust removal efficiency
- mercury and PCDD/F- where carbon (usually with alkaline reagent) is added as an absorbent on bag filters
- acid gases - where alkaline reagents are added to protect bag filters.

The benefits of these additional reductions may be small where upstream techniques are already being applied, that reduce the concentrations in the flue-gas to a low level.

### Cross-media effects

Cross-media effects are identified in the following table:

Criteria	Units	Range of achieved values	Comments
Energy requirements	kWh/t waste input		Increased due to pressure drop across process unit
Reagent consumption	kg/t waste input		More reagent used
Water Consumption			Wet ESP leads to water discharge, that may be recycled in the process.
Residue - type			Fly ashes and/or other substances removed in the polishing filter generally become an additional solid waste stream
Residue - amount	kg/t waste input		Varies according to input loads and applied upstream FGT techniques but will generally be low
Plume visibility	+/0/-	+/0	Non-dry systems can increase plume visibility

**Table 4.25: Cross-media effects associated with the use of additional flue-gas polishing**  
[74, TWGComments, 2004]

For this technique the most significant cross-media effects are:

- consumption of energy due to pressure drop across the bag filters
- production of solid residues (negligible in case of polishing purpose).

### Operational data

Effective maintenance of bag filters is very important to ensure their effective operation and hence low emissions. The pressure drop across the bags is monitored in order to maintain a cake on the filter. It can also be used as a means to detect bag damage (such as irreversible fouling). Dust emissions can usually be controlled to a very low level, simply by more closely observing the pressure drop and adopting stricter criteria (i.e. less latitude allowed before maintenance action is taken) for bag replacements. Analysis of the filter media may also be used to assess the reagent dose rate required and to assess its condition and its remaining lifetime.

Multiple chamber systems which are independently monitored for pressure drop, and bag houses with sufficient over capacity to allow damaged areas to be shut off for bag replacement, improve the capability to meet the lowest of emission limit values.

Bag filters are often divided into compartments that may be isolated for maintenance purposes. An even flue-gas distribution is important for optimal performance.

Criteria	Description of factors affecting criteria	Evaluation (High/Medium/Low) or data	Comment
Complexity	<ul style="list-style-type: none"> <li>• additional process units required</li> <li>• critical operational aspects</li> </ul>	H	Additional process units add complexity
Flexibility	<ul style="list-style-type: none"> <li>• ability of technique to operate under range of input conditions</li> </ul>	M	As a tail-end technique, the process will be less subject to such variations.
Skill requirements	<ul style="list-style-type: none"> <li>• significant extra training or manning requirements</li> </ul>	H	Bag filters require close maintenance

Table 4.26: Operational data associated with the use of flue-gas polishing

### Applicability

The applicability of this technique is assessed in the table below:

Criteria	Evaluation/Comment
Waste type	<ul style="list-style-type: none"> <li>• the additional abatement of heavy metals (with flue-gas) using these techniques increases suitability where these require further reduction</li> </ul>
Plant size range	<ul style="list-style-type: none"> <li>• larger plants with higher gas flows can achieve greater reductions in local contributions to emissions by applying such techniques</li> </ul>
New/existing	<ul style="list-style-type: none"> <li>• applicable to new and existing plants</li> <li>• as an end-of-pipe technique - well suited to retrofits where dust requires reduction</li> <li>• existing plants already achieving low emission levels (&lt;10 mg/Nm<sup>3</sup> daily average) through other means may not benefit greatly from the addition of this technique</li> </ul>
Inter-process compatibility	<ul style="list-style-type: none"> <li>• temperature and acid dew point needs consideration</li> <li>• provides effective gas cleaning step prior to SCR</li> </ul>
Key location factors	<ul style="list-style-type: none"> <li>• space available can be a restriction (additional process unit)</li> </ul>

Table 4.27: Assessment of the applicability of flue-gas polishing

### **Economics**

Cost information for this technique is given in Section 10.2.4

The key cost aspects of this technique are:

- increased capital investment costs of additional process unit
- increased operational costs - mainly due to energy requirements for pressure drop, provision of compressed air for back pulsing of BF (if used), and additional maintenance costs.

### **Driving force for implementation**

This technique has been implemented where:

- legislation has required low permit emission limit values for dust, (dust related) heavy metals, or where additional dioxin and acid gas reduction potential is required
- local air quality concerns exist that may be effected by the process
- it acts as a de-duster for a subsequent SCR process.

### **Example plants**

Examples in Germany, Austria and the Netherlands.

Other examples in France:

Toulouse: aggro-filtering modules after wet FGT

Tronville: tail end bag filter with lime + activated carbon injection (downstream wet FGT)

Ocreal: tail end bag filter with activated carbon injection for PCDD/F treatment

[74, TWGComments, 2004]

### **Reference literature**

[3, Austria, 2002], [2, infomil, 2002], [64, TWGComments, 2003]

## **4.4.2.3 Application of double bag filtration**

### **Description**

This technique considers the application of two bag filters in series in the FGT system. The 2 bag filters may not be immediately adjacent to one another (i.e. other FGT components may be used in between them). This technique does not refer to situations where a bag filter is combined with a non-bag filter e.g. with an ESP, cyclone, or wet scrubber etc.

### **Achieved environmental benefits**

Additional reduction in dust emissions to air. 24 hour average levels of below 1 mg/m<sup>3</sup> can be achieved in nearly all situations.

Separation of FGT residues is possible i.e. separation of fly ash from the FG neutralisation residues. This may then allow the recovery of one or other fraction where suitable outlets exist.



**Cross-media effects**

Cross-media effects are identified in the table below:

Criteria	Units	Range of achieved values	Comments
Energy requirements	kWh/t waste input	High	Increased due to pressure drop across process units
Reagent consumption	kg/t waste input	3 – 15	Depending on the kind of reagent
Residue - type		dry	Fly ashes and salts residue
Residue - amount	kg/t waste input	15 – 25	Varies according to input loads and applied upstream FGT techniques
Plume visibility	+/0/-	+/0	Spray dry systems can increase plume visibility

**Table 4.28: Cross-media effects associated with the use of double filtration**  
[74, TWGComments, 2004]

For this technique the most significant cross-media effects are:

- consumption of energy due to pressure drop across the FGT system as a whole, will be significantly higher
- production of solid residues (usually separated from other flue-gas residues).

It is reported that the additional energy consumption from the use of two bag filters in series (even if separated), although providing some potential benefits in terms of additional pollutant control, requires higher power fans to overcome the pressure drop and therefore higher electrical consumptions.

**Operational data**

Criteria	Description of factors affecting criteria	Evaluation (High/Medium/Low) or data	Comment
Complexity	<ul style="list-style-type: none"> <li>• additional process units required</li> <li>• critical operational aspects</li> </ul>	H	Additional process units add complexity
Flexibility	<ul style="list-style-type: none"> <li>• ability of technique to operate under range of input conditions</li> </ul>	H	Input to first stage can vary greatly without large variation in output emissions from second stage.
Skill requirements	<ul style="list-style-type: none"> <li>• notable extra training or manning requirements</li> </ul>	H	Bag filters require close maintenance. This is increased because of extra unit.

**Table 4.29: Operational data associated with the use of double filtration**

Bag filters are often divided into compartments that may be isolated for maintenance purposes. An even flue-gas distribution is important for optimal performance.

**Applicability**

This can be applied to any incineration process, but most applicable where very low dust ELVs are applied, or separation of FGT residue components is desired.

The applicability of this technique is assessed in the table below:

Criteria	Evaluation/Comment
<b>Waste type</b>	<ul style="list-style-type: none"> <li>any</li> </ul>
<b>Plant size range</b>	<ul style="list-style-type: none"> <li>larger plants with higher gas flows can achieve greater reductions in local contributions to emissions by applying such techniques</li> </ul>
<b>New/existing</b>	<ul style="list-style-type: none"> <li>applicable to new and existing plants</li> <li>where the additional filtration is added as an end-of-pipe technique it is well suited to retrofits at an existing installation</li> <li>existing plants already achieving low emission levels (&lt;10 mg/Nm<sup>3</sup> daily average) through other means may not benefit greatly from the addition of this technique</li> </ul>
<b>Inter-process compatibility</b>	<ul style="list-style-type: none"> <li>temperature and acid dew point needs consideration</li> <li>provides effective gas cleaning step prior to SCR</li> </ul>
<b>Key location factors</b>	<ul style="list-style-type: none"> <li>this requires larger space to implement</li> <li>location of the industrial plant that can re-cycle the salts</li> </ul>

**Table 4.30: Assessment of the applicability of double filtration**

[74, TWGComments, 2004]

### Economics

Additional cost of an extra process units. Additional energy costs and maintenance.

### Driving force for implementation

Most often applied where low emissions for dust are required (e.g. values below 2 mg/Nm<sup>3</sup>).

Possibility of salt recycling.

### Example plants

Several examples in Belgium, Germany, France and others.

### Reference literature

[64, TWGComments, 2003]

#### 4.4.2.4 Selection of bag filter materials

##### Description

The filter material selected must be suited to the physical and chemical conditions under which it will operate.

The key characteristics of fabrics for use in gas filtration include maximum operational temperature and resistance to acids, alkalis and flexing (due to bag cleaning). Also gas humidity can affect the strength and dimensional stability of the fabrics, due to hydrolysis. Several basic fibre properties are summarised below, some may be coated or impregnated with special chemicals (e.g. sulphur). [74, TWGComments, 2004]

Fabric	Maximum temperature (°C)	Resistance		
		Acid	Alkali	Physical flexibility
Cotton	80	Poor	Good	Very good
Polypropylene	95	Excellent	Excellent	Very good
Wool	100	Fair	Poor	Very good
Polyester	135	Good	Good	Very good
Nylon	205	Poor to fair	Excellent	Excellent
PTFE	235	Excellent	Excellent	Fair
Polyimide	260	Good	Good	Very good
Fibreglass	260	Fair to good	Fair to good	Fair
Notes:				
1. not all of these materials are commonly used in incineration – see operational data below				
2. Some operational experiences suggest a common maximum operational temperature to be 200°C.				

**Table 4.31: Operational information for different bag filter materials**  
[2, infomil, 2002] [67, Inspec, 2004]

### Achieved environmental benefits

Reliable filter material, suited to its application provides for reliable emissions abatement.

### Cross-media effects

If the media is not appropriate, pressure drop may increase and limit waste throughput.

If high pressure air is required for cleaning the bag it can reduce the bag lifetime.

### Operational data

See information provided in description above.

Increasing temperature may lead to melting of any plastic components in the fabric material, and the potential for fires. High humidity in the flue-gas may cause the filter materials to stick together and lead to shut downs. [74, TWGComments, 2004]PTFE covering of sheets/foils can be used to improve the removal of such sticky salts and solid particles from the bags. Operational improvements in semi-wet systems (see also Section 4.4.3.2) are reported to have been obtained by using PTFE in an MSWI facility in Prague (CZ) and in Schwandorf (Germany).

Regular bag analysis may help to assess its remaining lifetime [74, TWGComments, 2004]

Several filtration media are reported to not be commonly used in MSWI e.g. cotton, wool, propylene. In MSWI, the main media are: polyimide (known as P84), PPS (rarely), PTFE, fibreglass (with or without PTFE coating). Some fibres may be combined (e.g. P84+PTFE for higher resistance at high temperature)

Chemical reactions in the absorbent media may effect operational temperature. Quality of the scrim is also of importance, as well as fibre quality.

### Applicability

Correct bag material selection is relevant to all waste incineration installations using bag filters.

### Economics

Cost of the different bag filters varies.

### Driving force for implementation

Main driving forces are abatement performance and engineering suitability.

### Example plants

Wherever bag filters are applied i.e. very widely.

**Reference literature**

[2, infomil, 2002], [64, TWGComments, 2003]

**4.4.3 Reduction of acid gas emissions**

The sections that follow within this section deal with the following:

- description and assessment of the performance generally achieved by the main techniques applied for acid gas reduction – including consideration of applicability to various situations
- description and assessment of some other technological and procedural options relevant to acid gas removal.

**4.4.3.1 Wet scrubbing systems****Description**

This technique has already been described in Section 2.5.4.

Wet scrubbers generally have at least two effective stages, the first at low pH removes mainly HCl and HF, the second stage is dosed with lime or sodium hydroxide and operated at a pH of 6 - 8 primarily for the removal of SO<sub>2</sub>. Scrubber may sometimes be described as three or more stages – the additional stages generally being sub-division of the first low pH stage for specific purposes.

**Achieved environmental benefits**

Reduction of emissions to air as follows:

Substance(s)	Reduction efficiency range (%)	Achieved emissions				Comments
		½ hour average (mg/Nm <sup>3</sup> )	daily average (mg/Nm <sup>3</sup> )	annual average (mg/Nm <sup>3</sup> )	specific emission (g/t waste input)	
HCl		0.1 – 10	<5	0.1 - 1	1 – 10	Very stable outlet concentrations
HF		<1	<0.5	<0.1- 0.5	<0.05 – 2	Very stable outlet concentrations
SO <sub>2</sub>		<50	<20	<10	<5 – 50	Requires reaction stage and absorbent (lime or NaOH) SO <sub>2</sub> ½ hour averages may fluctuate more

**Table 4.32: Emission levels associated with the use of wet scrubbers**

[1, UBA, 2001, 2, Infomil, 2002, 12, Achternbosch, 2002]

Wet FGT systems provide the highest removal efficiencies (for soluble acid gases) of all FGT systems with lowest excess stoichiometric factors. [74, TWGComments, 2004]

Whilst single stage filtration based FGT systems (e.g. semi-wet, dry) combine and collect residues together, this is not generally the case with wet systems. The wet systems can treat HCl, HF and SO<sub>2</sub> separately from particulate, etc which is often removed before. Having noted this, wet systems do provide some additional reductions of the following substances:

- dust - where scrubber capacity is large enough to prevent clogging (most usually a pre-dedusting stage is used before the wet scrubber to reduce dust loads and prevent operational problems up to 50 % of the dust input) [74, TWGComments, 2004]
- PCDD/F - if carbon impregnated packing materials are used it is possible for reductions of 70 % to be seen across the scrubber, otherwise removal rates are negligible. Activated carbon or coke may be added to the scrubber for a similar purpose, with reported higher removal efficiencies [74, TWGComments, 2004]
- Hg<sup>2+</sup> - if a low pH (~1) first stage scrubber is used, and HCl concentrations in the waste provide for acidification of this stage, then HgCl<sub>2</sub> removal can take place, but metallic Hg is not generally effected. [64, TWGComments, 2003]
- other pollutants - when water soluble pollutants like bromine and iodine are present in the raw gas, they may be condensed at the low temperatures in the scrubber and by that get into the scrubber waste water.

### Cross-media effects

Cross-media effects are identified in Table 4.35 below:

Criteria	Units	Range of values	Comments
Energy requirements	kWh/t waste input	19	Pumps add demand
Reagent consumption	kg/t waste input	2 – 3 (NaOH) or ~10 (CaO) or 5 – 10 (lime/limestone)	Lowest of all systems
Reagent stoichiometry	Ratio	1.0 – 1.2	Lowest of all systems
Residue - type			Effluent treatment sludge; in some cases HCl or gypsum may be recovered
Residue - amount	Kg (wet)/t waste input Kg (dry)/t waste input	10 – 15 3 – 5	Lowest of all systems. This figure does not include separately removed fly ash approx. 16 kg/t input.
Water consumption	l/t waste input	100 – 500	Highest of all systems but can be reduced by treatment and recirculation /condensation and by low temperatures before scrubber inlet.
Effluent production	l/t waste input	250 – 500	Treatment required before discharge or re-use
Plume visibility	+/-	+	High gas moisture content, but can be reduced by reheat/condensation
Note: the data in this table aims to provide the typical operational range. The precise amounts of residues and effluents produced will depend on many factors including raw gas concentrations (waste related), flowrates, reagent concentrations, etc.			

**Table 4.33: Cross-media effects associated with the use of wet scrubber FGT**  
[1, UBA, 2001, 2, infomil, 2002, 12, Achternbosch, 2002]

For this technique, the most significant cross-media effects compared to other options are:

- lowest reagent consumption rates
- lowest solid residue production rates
- higher water consumption
- production of an effluent that requires management
- increased plume visibility
- PCDD/F build up (memory effect) on scrubber plastic components requires addressing
- if input temperature is too high the material used in the wet scrubber may be destroyed. [74, TWGComments, 2004]

Effluent production is usually considered as 300 kg/t MSW input, assuming a consumption of water of 1000 kg/t MSW input. These figures are higher than those quoted in the table above. [64, TWGComments, 2003]

### Operational data

Criteria	Description of factors affecting criteria	Evaluation (High/Medium/Low) or data	Comment
<b>Complexity</b>	<ul style="list-style-type: none"> <li>• additional process units required</li> <li>• critical operational aspects</li> </ul>	H	The number of process units is greater than other systems
<b>Flexibility</b>	<ul style="list-style-type: none"> <li>• ability of technique to operate under range of input conditions</li> </ul>	H	Very robust - highest ability of all systems to achieve emission reduction of HCl/HF under fluctuating inlet concentrations.
<b>Skill requirements</b>	<ul style="list-style-type: none"> <li>• notable extra training or manning requirements</li> </ul>	H	The associated effluent treatment plant requires a high skill input

**Table 4.34: Operational data associated with the use of wet FGT**

The main issues are:

PCDD/F build up in wet scrubbers can be a problem, in particular from maintenance and start up periods, and may require specific measures to be taken.

Effluent treatment requires high skilled operation to achieve low emission levels.

For effective operation, wet scrubbers require flue-gases that have already been de-dusted using e.g. ESP or BF. [64, TWGComments, 2003]

The flexibility of wet scrubbing in respect of variation in inlet concentration applies mainly to HCl and HF. Sometimes additional treatment is required to meet mercury ELVs, for example: the injection of a complex builder in the basic scrubber; injection of activated carbon in the acidic scrubber; injection of oxidising agent or abatement in the gas phase with adsorbent. [64, TWGComments, 2003]

### Applicability

The applicability of this technique is assessed in the table below:

Criteria	Evaluation/comment
<b>Waste type</b>	<ul style="list-style-type: none"> <li>can be applied in principle to any waste type</li> <li>particularly suited to highly variable inlet gas compositions (e.g. hazardous wastes)</li> </ul>
<b>Plant size range</b>	<ul style="list-style-type: none"> <li>not restricted but generally applied at medium to larger plants where economies of scale exist</li> </ul>
<b>New/existing</b>	<ul style="list-style-type: none"> <li>widely applied at many existing plants</li> </ul>
<b>Inter-process compatibility</b>	<ul style="list-style-type: none"> <li>low flue-gas outlet temperature (approx. 70 °C) requires reheat for subsequent FGT systems e.g. bag filters and SCR</li> <li>separate (pre-) collection of fly ash possible</li> </ul>
<b>Key location factors</b>	<ul style="list-style-type: none"> <li>increased plume visibility (unless counter measures taken)</li> <li>salt water effluent (post treatment) requires discharge (or evaporation which requires energy)</li> <li>can permit recovery of HCl, salt, gypsum</li> </ul>

**Table 4.35: Assessment of the applicability of wet FGT**

### Economics

Capital cost information for the technique is shown in the table below:

FGT component	Estimated investment cost (M EUR)	Comments
<b>Two stage wet scrubber</b>	5	including waste water treatment
<b>Three stage wet scrubber</b>	7	including waste water treatment
<b>External scrubber effluent evaporation plant</b>	1.5 – 2	
<b>Spray absorber for internal effluent evaporation</b>	1.5	Cost estimate believed to be on the low side
Costs estimated relate to a 2 line MSWI of total capacity 200 kt/yr		

**Table 4.36: Estimated investment costs of selected components of wet FGT systems [12, Achternbosch, 2002] [74, TWGComments, 2004]**

The key cost aspects of this technique compared to the alternatives are:

- higher capital investment costs than other systems, mainly due to the effluent treatment plant and the higher number of process units required
- operational costs associated with disposal of residues may be lower, due to the lower specific residue production, which are normally wet. [74, TWGComments, 2004]
- labour costs higher due to increased complexity of system.

### Driving force for implementation

This technique has been implemented where:

- emission limit values have been set at or below those detailed in Directive 2000/76/EC
- disposal costs for flue-gas treatment residues are high
- input waste composition is particularly difficult to predict/control
- input waste may contain high and variable loads of acid gases or heavy metals (i.e. ionic mercury) [74, TWGComments, 2004]
- salt containing effluent may be discharged (e.g. to the sea).

### Example plants

Wet flue-gas scrubbing is widely used throughout Europe for a full range of waste types.

**Reference literature**

[1, UBA, 2001, 2, infomil, 2002, 3, Austria, 2002, 12, Achternbosch, 2002] [64, TWGComments, 2003]

**4.4.3.2 Semi-wet scrubbing systems****Description**

This techniques has already been described in Section 2.5.4.

The diagram below shows a typical semi-wet FGT system, with a contact tower on the left and downstream deduster:

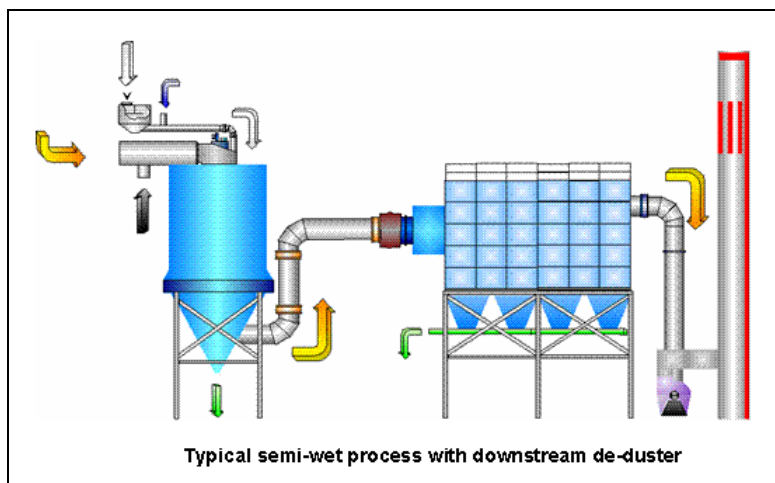

Figure 4.6: Diagram showing typical design of a semi-wet FGT system

**Achieved environmental benefits**

Reduction of emissions to air as follows:

Substance (s)	Reduction efficiency range (%)	Achieved emissions				Comments
		½ hour average mg/Nm <sup>3</sup>	daily average mg/Nm <sup>3</sup>	Annual average mg/Nm <sup>3</sup>	Specific emission (g/t waste input)	
HCl		<50	3 – 10	2	4 – 10	Lowest values achieved with higher reagent dosing and regulation control. Peaks can be dealt with by upstream HCl analyser. The semi-wet process can capture SO <sub>2</sub> at the same time as HCl and HF in the same scrubber.
HF		<2	<1	<0.5	<2	
SO <sub>2</sub>		<50	<20	<10	5 – 50	

Table 4.37: Emission levels associated with the use of wet scrubbers

[1, UBA, 2001, 2, infomil, 2002, 12, Achternbosch, 2002], [64, TWGComments, 2003] [74, TWGComments, 2004]

There is no effluent discharge from semi-wet scrubbers as the amount of water used is generally lower than with wet scrubbers and that used is evaporated with the flue-gases. If of suitable quality, other site waste water (e.g. rainwater) may be sent to the FGT system.. [74, TWGComments, 2004]



Semi-wet FGT systems provide high removal efficiencies (for soluble acid gases). Low ELVs can be met by adjusting the reagent dosing rate and design point of the system, but generally at the cost of increased reagent consumption and residue production rates.

Semi-wet systems are used with fabric filters to remove the reagents added and their reaction products. Reagents, other than alkaline reagents, can also be added to adsorb other flue-gas components (e.g. activated carbon for Hg and PCDD/F).

They are most commonly used as a single stage reactor/filter for the combined emission reduction of:

- dust - filtered by the fabric filter
- PCDD/F - adsorbed if activated carbon is injected as well as alkaline reagent
- Hg - adsorbed if activated carbon is injected as well as alkaline reagent.

### Cross-media effects

Cross-media effects are identified in the following table:

Criteria	Units	Range of achieved values	Comments
<b>Energy requirements</b>	kWh/t waste input	6 – 13	Pressure drop across bag filter creates energy demand
<b>Reagent consumption</b>	kg/t waste input	12 – 20 (lime)	Mid range of system options applied
<b>Reagent stoichiometry</b>	Ratio	1.4 – 2.5	Lowest values achieved with recirculation/with low pollution load wastes
<b>Residue - type</b>	kg	Not supplied	Combined FGT and fly ash
<b>Residue - amount</b>	kg/t waste input	25 – 50	Combined FGT and fly ash
<b>Water consumption</b>	l/t waste input	Not supplied	Lowest where FGT inlet temperature is low otherwise water for cooling also necessary
<b>Effluent production</b>	l/t waste input	Not supplied	
<b>Plume visibility</b>	+/o/-	0	Mid range of applied systems
Note: the data in this table aims to provide the typical operational range. The precise amounts of residues and effluents produced will depend on many factors including raw gas concentrations (waste related), flowrates, reagent concentrations etc.			

**Table 4.38: Cross-media effects associated with the use of semi-wet acid gas treatment**

Source [3, Austria, 2002, 12, Achternbosch, 2002], [64, TWGComments, 2003] [74, TWGComments, 2004]

For this technique the most significant cross-media effect is:

- higher residue production rates than wet systems.

Separate collection of fly ash is possible if this system is preceded by an ESP. This, then increases separation of fly ash and FGT residues, which can be beneficial if separate treatment/recycling options exist for these residues.

The semi-wet FGT system is often applied as a single stage, multi reactor. Such systems usually have lower energy requirements than more complex multi stage FGT systems.

## Operational data

Criteria	Description of factors affecting criteria	Evaluation (High/Medium/Low) or data	Comment
<b>Complexity</b>	<ul style="list-style-type: none"> <li>additional process units required</li> <li>critical operational aspects</li> </ul>	M	<ul style="list-style-type: none"> <li>the number of process units is lower than wet systems, but greater than dry and flash dry.</li> <li>inlet temperature requires control</li> <li>pre-dust removal may ease semi-dry operation</li> </ul>
<b>Flexibility</b>	<ul style="list-style-type: none"> <li>ability of technique to operate under range of input conditions</li> </ul>	M	<ul style="list-style-type: none"> <li>can achieve low emission levels under most conditions</li> <li>rapid inlet load changes can be problematic</li> </ul>
<b>Skill requirements</b>	<ul style="list-style-type: none"> <li>significant extra training or manning requirements</li> </ul>	M	<ul style="list-style-type: none"> <li>no effluent treatment requirements</li> <li>care required to optimise reagent dosing</li> </ul>

Table 4.39: Operational data associated with the use of semi-wet FGT

Most systems consist of only a reagent mixing unit (reagent plus water) and a spray tower, and then a bag filter - complexity is therefore lower than with wet FGT systems.

The reagent handling and dosing require good management to ensure effective and optimised operation, particularly where heterogeneous waste types are treated e.g. merchant HWIs. Upstream HCl monitoring (see Section 4.4.3.9) improves optimisation of reagent dosing in these systems and allows management of peak loads of HCl, HF, SO<sub>2</sub> without high reagent dosing rates.

Some installations produce the Ca(OH)<sub>2</sub> for the FGT system by on-site by slaking of CaO. Effective lime preparation can be critical to good operation, as can be controlling the risk of fouling in the injection device. The injectors have to be located and designed such that they can be easily maintained and/or replaced for cleaning. [74, TWGComments, 2004]

Bag filters require close monitoring and management to address bag damage and consequent releases. Differential pressure monitors are commonly used to indicate bag damage and monitor operation in general.

Temperature requirements are critical. Care is required to ensure dew point corrosion in the bag filter is avoided - inlet gas temperatures of above 130 – 140 °C are usually used. At temperature below 130 °C there may be problems due to the hygroscopic nature of the CaCl<sub>2</sub> formed. Reagents usually require a specific temperature for optimal reaction conditions.

It is reported that there may be operational problems when semi-wet FGT systems are used with very highly acidic polluted raw gases as this can lead to increased risk of filter clogging.

The operational complexity of reactor and bag filter used in semi-dry systems can themselves be decreased further by the use of a degree of pre-dedusting e.g. use of one stage ESP, or by using non-sticky bag materials (see also Section 4.4.2.4). This helps because it avoids the problems of:

- sticking of some zinc (and similar salts with low melting temperature) and
- hygroscopic salts forming sticking layers on the surface of the reactor.

[64, TWGComments, 2003]

### Applicability

The applicability of this technique is assessed in the table below:

Criteria	Evaluation/comment
<b>Waste type</b>	<ul style="list-style-type: none"> <li>• suited to most waste types</li> <li>• generally less capable of dealing with very highly variable inlet concentrations than wet scrubbers</li> </ul>
<b>Plant size range</b>	<ul style="list-style-type: none"> <li>• applied at all size ranges</li> </ul>
<b>New/existing</b>	<ul style="list-style-type: none"> <li>• applied at new plants and as a retrofit</li> </ul>
<b>Inter-process compatibility</b>	<ul style="list-style-type: none"> <li>• flue-gas outlet temperature (120 – 170 °C) requires reheat for subsequent FGT systems e.g. SCR</li> <li>• separate (pre-) collection of fly ash possible</li> <li>• bag filter provides effective gas cleaning step for subsequent SCR or wet system (if used as pre-deduster).</li> </ul>
<b>Key location factors</b>	<ul style="list-style-type: none"> <li>• no effluent is produced and no discharge required</li> <li>• availability/cost of solid residue outlets</li> </ul>

**Table 4.40: Assessment of the applicability of semi-wet FGT**

### Economics

Capital cost information for the technique is shown in the table below:

FGT component(s)	Estimated investment cost (EUR million)	Comments
<b>Fabric filter</b>	2	
<b>Spray dryer</b>	1 – 1.5	
Costs estimated related to a 2 line MSWI of total capacity 200 K t/yr		

**Table 4.41: Estimated investment costs of selected components of typical semi-wet FGT systems**  
Source [12, Achternbosch, 2002]

Key operational factors of this technique are:

- investment costs are lower than for wet FGT systems, especially for relatively small capacities. [2, infomil, 2002] p 119
- possible higher cost of disposal of the higher quantity of residues produced (than wet systems)
- reduced labour cost (cf. wet systems) due to lower complexity, particularly because it avoids the costs of the operation of an effluent treatment plant
- increased alkaline reagent cost due to higher stoichiometric ratios.

## Driving force for implementation

This technique has been implemented where:

- emission limit values have been set at those detailed in Directive 2000/76/EC
- wastes treated do not result in very high and variable inlet flue-gas loads
- outlets exist for solid residues produced
- effluent production is not desirable
- water supplies are limited because of the lower water consumption
- the infrastructure for waste water handling is not available, or limited, e.g. remote rural areas in dry climates due to the lack of need for effluent treatment
- lower plume visibility with non-wet systems may also be a particular advantage in areas where there is high sensitivity to visual impacts. [64, TWGComments, 2003]

## Example plants

Widely used in Europe e.g. UK, D, F, DK.

## Reference literature

[1, UBA, 2001, 2, infomil, 2002, 3, Austria, 2002, 12, Achternbosch, 2002, 26, RSP, 1999, 54, dechefdebien, 2003], [64, TWGComments, 2003]

### 4.4.3.3 Intermediate systems with some water addition and residue recirculation (flash dry systems)

#### Description

This technique has already been described in Section 2.5.4. The technique has elements of both semi-dry and dry systems, and is mainly characterised by low water addition and high residue re-circulation rates.

This technique is reported to only be applied when lime is the reagent. [74, TWGComments, 2004]

#### Achieved environmental benefits

Reduction of emissions to air as follows:

Substance(s)	Reduction efficiency range (%)	Achieved emission ranges				Comments
		½ hour average (mg/Nm <sup>3</sup> )	daily average (mg/Nm <sup>3</sup> )	annual average (mg/Nm <sup>3</sup> )	specific emission (g/t waste input)	
HCl	>99	<10	<6	2.9	10 – 30	Stable due to high circulation rate
HF	>99.5	<2	<1	<0.5	1 – 5	Stable due to high circulation rate
SO <sub>2</sub>	>99	<50	<5	<1	5 – 50	Stable due to high circulation rate

**Table 4.42: Emission levels associated with the use of flash dry FGT**  
[57, Alstom, 2003] [64, TWGComments, 2003] [74, TWGComments, 2004]

The process, in combination with bag filters and reagent addition, also provides for the emission reduction of:

- dust and associated heavy metals (to 0.4 – 2 mg/Nm<sup>3</sup>)
- Hg (with carbon injection to 0.002 – 0.015 mg/Nm<sup>3</sup>)
- PCDD/F (with carbon injection to 0.005 – 0.1 ng/Nm<sup>3</sup>).

The re-circulation of reagents generally used with this system has the following advantages compared with other FGT systems:

- reduced reagent consumption (cf. dry and semi-wet systems)
- reduced solid residue production (contains less un-reacted reagent)
- reduced water consumption and no effluent production (cf. wet systems).

### Cross-media effects

Cross-media effects are identified in the table below:

Criteria	Units	Range of achieved values	Comments
Energy requirements	kWh/t waste input		<ul style="list-style-type: none"> <li>• pressure drop of bag filter is main consumer</li> <li>• circulation system consumes energy</li> </ul>
Reagent consumption	kg/t waste input	7 – 15 (lime)	
Reagent stoichiometry	ratio	1.2 – 1.8	
Residue - type			<ul style="list-style-type: none"> <li>• combined FGT and fly ashes (if no pre-collector)</li> <li>• lower levels of un-reacted reagents</li> </ul>
Residue - amount	kg/t waste input	12 – 25	
Water consumption	l/t waste input		Dependent on in-going flue-gas temperature cooling required to achieve operating temperature
Effluent production	l/t waste input	0	
Plume visibility	+/-	0	<ul style="list-style-type: none"> <li>• minimal water addition for conditioning</li> </ul>

Note: the data in this table aims to provide the typical operational range. The precise amounts of residues and effluents produced will depend on many factors including raw gas concentrations (waste related), flowrates, reagent concentrations etc.

**Table 4.43: Cross-media effects associated with the use of flash dry systems**  
[3, Austria, 2002, 12, Achternbosch, 2002, 57, Alstom, 2003] [74, TWGComments, 2004]

For this technique, the most significant cross-media effects are:

- production of solid residues
- energy consumption from pressure drop associated with use of the bag filter.

## Operational data

Criteria	Description of factors affecting criteria	Evaluation (high/medium/low) or data	Comments
<b>Complexity</b>	<ul style="list-style-type: none"> <li>additional process units required</li> <li>critical operational aspects</li> </ul>	M	<ul style="list-style-type: none"> <li>very few process components</li> <li>care required to ensure effective circulation of reagent and humidity control</li> </ul>
<b>Flexibility</b>	<ul style="list-style-type: none"> <li>ability of technique to operate under range of input conditions</li> </ul>	H/M	<ul style="list-style-type: none"> <li>large buffer volume of circulating reagent increases flexibility</li> <li>not as flexible as wet systems</li> </ul>
<b>Skill requirements</b>	<ul style="list-style-type: none"> <li>notable extra training or manning requirements</li> </ul>	M	<ul style="list-style-type: none"> <li>simple system</li> </ul>

**Table 4.44: Operational data associated with the use of flash dry FGT**  
[57, Alstom, 2003] [74, TWGComments, 2004]

Reagent injection and residue bleed rates require optimisation to prevent absorbent loading and eventual substance breakthrough (e.g. Hg and PCDD/F absorbed on carbon).

Moisture levels require monitoring and control to maintain acid gas absorption efficiency.

Upstream HCl monitoring is used to optimise alkaline reagent/water dose rates.

### Applicability

The applicability of this technique is assessed in the table below:

Criteria	Evaluation/comment
<b>Waste type</b>	<ul style="list-style-type: none"> <li>all waste types except where inlet concentrations are highly variable e.g. merchant hazardous wastes</li> <li>currently applied to: MSW, RDF, wood wastes</li> </ul>
<b>Plant size range</b>	<ul style="list-style-type: none"> <li>mainly applied at small to medium scale plants owing to increased scale of filter required (to accommodate re-circulated residues)</li> </ul>
<b>New/existing</b>	<ul style="list-style-type: none"> <li>no specific restrictions</li> <li>filters need to be larger than other systems to accommodate re-circulated</li> </ul>
<b>Inter-process compatibility</b>	<ul style="list-style-type: none"> <li>can provide pre-dusting for SCR system</li> <li>can be operated with SNCR</li> </ul>
<b>Key location factors</b>	<ul style="list-style-type: none"> <li>small footprint</li> <li>less suitable where outlets already exist for treatment/recovery of segregated fly ash</li> </ul>

**Table 4.45: Assessment of the applicability of flash dry FGT**  
[57, Alstom, 2003]

### Economics

Capital costs are reported to be somewhat lower than wet and semi-wet systems due to the reduced number of process components and consequently the smaller footprint. Slightly greater capital cost than dry gas cleaning. However, the bag filter size increase, the larger capacity required, and other specific recirculation equipment is also reported to increase costs when residues are re-circulated. [74, TWGComments, 2004]

Operational costs associated with reagent consumption and residue production will be between those of semi-wet and dry systems using similar degrees of re-circulation. Running costs are reported to be reduced when using re-circulation (a common feature with this system) because of lower reagent consumption (improved stoichiometric ratio cf. dry and semi-wet systems and no requirement for water treatment cf. wet system) and reduced residue disposal costs.

### Driving force for implementation

This technique has been implemented where:

- reagent consumption requires specific reduction
- residue production requires reduction
- space required is restricted
- process complexity is a concern.

### Example plants

Some existing processes/plants in: Sweden, Norway, Germany and Denmark.

### Reference literature

[57, Alstom, 2003] [64, TWGComments, 2003]

### 4.4.3.4 Dry FGT systems

#### Description

This techniques has already been described in Section 2.5.4

Lime (e.g. hydrated lime, high specific surface area lime) and sodium bicarbonate are commonly used as the alkaline reagents. The addition of activated carbon provides for the reduction by absorption of Hg and PCDD/F.

When finely ground sodium bicarbonate is injected into hot gases (above 140 °C) it converts it to sodium carbonate of high porosity and hence is effective for acid gas absorption. [59, CEFIC, 2002]

#### Achieved environmental benefits

Reduction of emissions to air as follows:

Substance(s)	Reduction efficiency range (%)	Achieved emission ranges				Comments
		½ hour average mg/Nm <sup>3</sup>	daily average mg/Nm <sup>3</sup>	annual average mg/Nm <sup>3</sup>	specific emission (g/tonne waste input)	
HCl		<60	<10			Information supplied states compliance with air ELVs in EC/2000/76.
HF		<4	<1			
SO <sub>2</sub>		<200	<50			

Table 4.46: Emission levels associated with the use of dry lime FGT

Substance(s)	Reduction efficiency range (%)	Achieved emission ranges				Comments
		½ hour average mg/Nm <sup>3</sup>	daily average mg/Nm <sup>3</sup>	annual average mg/Nm <sup>3</sup>	specific emission (g/tonne waste input)	
HCl		<20	<5			
HF		<1	<1			
SO <sub>2</sub>		<30	<20			

Table 4.47: Emission levels associated with the use of dry sodium bicarbonate FGT

[59, CEFIC, 2002] [74, TWGComments, 2004]

Although compliance with EC/2000/76 is achieved using this technique, it is generally, for a given situation, not possible to reach the same very low emission limits as other FGT systems without increasing reagent dosing rates and consequent residue production. Reagent recycling can reduce these cross-media effects to some degree, but can lead to operational difficulties in respect of reagent dosing systems.

### Cross-media effects

Cross-media effects are identified in the table below:

Criteria	Units	Range of achieved values	Comments
Energy requirements	kWh/t waste input		Mainly from pressure drop across bag filter Higher operational temperature can lead to savings for FG reheat
Reagent consumption	kg/t waste input	10 – 15	Figure relates to sodium bicarbonate consumption in MSWI
Reagent stoichiometry	ratio	1.25 (NaHCO <sub>3</sub> ) 1.5 – 2.5 (CaOH)	Typical excess of 25 % with sodium bicarbonate Lower values with lime achieved with re-circulation
Residue - type			FGT residues with fly ash or separated if pre-dedusting
Residue - amount	kg/t waste input	7 – 25	From one tonne MSW
Water consumption	l/t waste input	0	Not required
Effluent production	l/t waste input	0	None
Plume visibility	+/o/-	-	Lowest of all systems

Note: in-situ operational values will vary depending upon local variations in waste type etc.

**Table 4.48: Cross-media effects associated with the use of dry FGT [64, TWGComments, 2003]**

For this technique the most significant cross-media effect is the production of solid residues, which is generally larger than with other systems (all things equal), although the excess may be reduced somewhat by residue re-circulation (note: operational specifics).

With sodium bicarbonate the solid residues are more soluble than with lime, but significantly lower in quantity than with dry lime system. Residues from bicarbonate systems have in some cases been treated and recycled in the chemical industry. [74, TWGComments, 2004]

### Operational data

Criteria	Description of factors affecting criteria	Evaluation (high/medium/low) or data	Comment
Complexity	<ul style="list-style-type: none"> <li>additional process units required</li> <li>critical operational aspects</li> </ul>	L	<ul style="list-style-type: none"> <li>simple process of few components</li> </ul>
Flexibility	<ul style="list-style-type: none"> <li>ability of technique to operate under range of input conditions</li> </ul>	M/L	<ul style="list-style-type: none"> <li>can cope with high acid loads</li> <li>wide operational temperature range (with sodium bicarbonate (140 – 300 °C))</li> </ul>
Skill requirements	<ul style="list-style-type: none"> <li>notable extra training or manning requirements</li> </ul>	M/L	<ul style="list-style-type: none"> <li>simple system</li> <li>bag filter requires effective management</li> </ul>

**Table 4.49: Operational data associated with the use of dry FGT [59, CEFIC, 2002]**



Dry reagents need to be handled in such a manner to prevent dust emissions e.g. emissions from loading silo breather vents.

It is reported that the use of operational temperatures above approx. 180 °C may give rise to a deterioration in the PCDD/F and Hg adsorption performance of injected carbon reagents.

### Applicability

The applicability of this technique is assessed in the table below:

Criteria	Evaluation/comment
<b>Waste type</b>	<ul style="list-style-type: none"> <li>Applied to a full range.</li> </ul>
<b>Plant size range</b>	<ul style="list-style-type: none"> <li>Modern dry systems applied to wide size range</li> </ul>
<b>New/existing</b>	<ul style="list-style-type: none"> <li>no restriction</li> </ul>
<b>Inter-process compatibility</b>	<ul style="list-style-type: none"> <li>higher operational temperatures makes the process well suited to combination with downstream SCR</li> </ul>
<b>Key location factors</b>	<ul style="list-style-type: none"> <li>low plume visibility</li> <li>no effluent produced</li> <li>residue treatment/disposal needs consideration</li> </ul>

**Table 4.50: Assessment of the applicability of dry FGT**  
[59, CEFIC, 2002], [64, TWGComments, 2003]

### Economics

Process unit costs are similar to semi-wet systems except:

- a relatively bigger bag house filter is generally used with dry systems
- higher possible operational temperature can lead to savings for flue-gas reheat e.g. for SCR
- reagent slurry handling/mixing unit not required with dry systems.

### Operational costs

- increased reagent consumption rates, cf. wet FGT
- increased disposal costs for residues, cf. other FGT systems
- savings through lack of effluent for treatment/disposal.

### Driving force for implementation

The simplicity of such systems is the main reason for their use.

This technique has been implemented where ELV have been set at those detailed in Directive 2000/76/EC.

Restrictions on water supply and outlets make the use of dry FGT systems favourable. In some cases permitting authorities have placed specific conditions forbidding water discharges – dry (and semi-dry) systems are then favoured.

### Example plants

Widely used throughout Europe. Over 110 plants are operating in more than 10 European countries, Japan and the US.

There are examples of merchant HWT's using dry systems in France.

Growth rate of approximately 10 to 15 plants per year.

### Reference literature

[59, CEFIC, 2002] [2, infomil, 2002] [64, TWGComments, 2003]

### 4.4.3.5 Selection of alkaline reagent

#### Description and achieved environmental benefits

Various alkaline reagents (and combinations) are used in FGT systems of waste incineration plants. The different options have various advantages and disadvantages and are usually strongly influenced by overall technology selection.

Lime is used in all types of FGT systems, although most often with wet and semi-wet systems. It is used as hydrated lime in dry systems, as slaked lime in semi-wet systems, and also as high specific surface (HSS) lime [74, TWGComments, 2004] Sodium bicarbonate is applied to a range of mainly dry systems. Sodium hydroxide and lime stone are generally only applied to wet FGT systems. The advantages and disadvantages of the use of each reagent are highlighted in the table below:

Reagent	Advantages	Disadvantages	Comments/other data
Sodium Hydroxide	<ul style="list-style-type: none"> <li>highly reactive with acid gases</li> <li>low consumption rates</li> <li>low solid waste production</li> </ul>	<ul style="list-style-type: none"> <li>higher cost/kg reagent</li> <li>variable cost (quarterly)</li> <li>soluble salts formed</li> <li>highly corrosive material</li> <li>odour if in contact with humidity</li> </ul>	<ul style="list-style-type: none"> <li>only used in wet systems</li> </ul>
Lime	<ul style="list-style-type: none"> <li>medium reactivity (higher reactivity with HSS lime)</li> <li>possibility to operate at higher temperature with HSS lime</li> <li>lower cost/kg reagent</li> <li>low solubility residues</li> <li>can allow gypsum recovery from wet scrubbers</li> </ul>	<ul style="list-style-type: none"> <li>handling can be problematic and recycling difficult</li> </ul>	<ul style="list-style-type: none"> <li>residues from lime-based dry, intermediate and semi-dry systems are highly alkaline</li> </ul>
Lime stone	<ul style="list-style-type: none"> <li>medium reactivity</li> <li>lower cost/kg reagent</li> <li>low solubility residues</li> <li>can allow gypsum recovery from wet scrubbers</li> </ul>	<ul style="list-style-type: none"> <li>releases CO<sub>2</sub>, which must be stripped off by bleeding from an HCl scrubber</li> </ul>	<ul style="list-style-type: none"> <li>Not widely applied in MSWI</li> <li>mainly used in wet systems</li> <li>sometimes used in fluid bed systems</li> </ul>
Sodium Bicarbonate	<ul style="list-style-type: none"> <li>highly reactive both on SO<sub>2</sub> and HCl</li> <li>low consumption rates (stoichiometric ratio ~1.25)</li> <li>low residue production depending on the stoichiometric purification and re-use of residue possible and applied</li> <li>effective over wide FGT operational temperature range (140 – 300 °C, see comments in “operational data below)</li> <li>high operational temperature range and high efficiency on SO<sub>2</sub> may increase compatibility with SCR</li> <li>no water injection/humidity control required</li> </ul>	<ul style="list-style-type: none"> <li>higher soluble part in residue</li> <li>soluble solid residues formed can be problematic for disposal (but use in chemicals industry possible)</li> <li>higher cost than lime/kg reagent</li> <li>size reduction device is required and may cause problems of availability due to fouling</li> </ul>	<ul style="list-style-type: none"> <li>10 – 15 kg/t MSW incinerated without fly and boiler ash</li> </ul>

**Table 4.51: Comparison of features of various alkaline reagents**  
[64, TWGComments, 2003] [74, TWGComments, 2004]

### Cross-media effects

The most significant cross-media factors to take account of in reagent selection are:

- quantity of residue production
- possibilities for re-cycle of residue produced (off site)
- nature/composition of residue and its impact on subsequent disposal/re-cycling etc
- production and management of effluents containing soluble salts.

Residues of chlorides from removal of hydrochloric acid in the flue-gas are highly soluble.

### Operational data

See comments given in Table 4.51 above. The temperature range which is adequate for the dry sodium bicarbonate process is linked to the phenomenon of the transformation of sodium bicarbonate to sodium carbonate; this phenomenon increases the surface area and porosity of the reagent and hence its reactivity. The phenomenon is observable from temperatures around 100 °C, but higher temperatures are required to ensure reaction kinetics are acceptable. From 140 °C the kinetics are generally fast enough, with experience of further increases in reactivity at temperatures of 160 - 180 °C. In some cases mixed FGT systems are implemented: they can operate either with HSS lime or sodium bicarbonate. Although less operationally optimised, reagent costs may thus be better controlled. [74, TWGComments, 2004]

### Applicability

The applicability of this technique is assessed in the table below:

Criteria	Evaluation/comment
<b>Waste type</b>	• NaOH is well suited to variable inlet concentrations e.g. HWI.
<b>Plant size range</b>	• For cost reasons NaOH is less attractive in larger plants than CaCO <sub>3</sub>
<b>New/existing</b>	• can be applicable to both
<b>Inter-process compatibility</b>	• NaOH used only in wet systems
<b>Key location factors</b>	• disposal/recycling options for residues produced may be influential • local cost/availability of reagents may be a factor

**Table 4.52: Assessment of the applicability of various alkaline reagents**  
Source [64, TWGComments, 2003] [74, TWGComments, 2004]

### Economics

Reagent associated costs are one component in the overall FGT selection and may not be critical on their own.

Overall reagent cost is a factor of both the unit cost per kilogram of reagent and the amount required (stoichiometric ratio) as well the availability and cost of residue treatment/disposal options. For example, for dry FGT systems, lime has the lowest reagent cost per kilogram of reagent, but the lower dose rates (kg reagent per tonne waste treated) encountered with sodium bicarbonate mean that effective reagent cost per unit of waste treated will be similar. The relative prices and availability of residue treatment/disposal options may then become a determining factor.

Some additional cost information and estimates are given in the annex to this document (see Section 10.2.4).

NaOH prices are reported to vary.

### Driving force for implementation

Key driving forces for the selection of reagents are:

- ability to treat flue-gases of the waste in question
- compatibility with the rest of the installation/FGT system
- reagent cost per tonne of waste treated
- availability and cost of residue disposal/treatment outlets.

### Example plants

Lime, sodium hydroxide and lime stone are all used in a wide variety of incineration plants throughout Europe and elsewhere. The total number of WI plants in Europe alone using these reagents is estimated to exceed 100.

The dry sodium bicarbonate FGT is used in more than 130 plants in more than 10 European countries, as well as in Japan (it is also recognised as a reference process in the United States). [64, TWGComments, 2003]

In these 130 plants, there are about 75 incineration plants:

- 36 municipal waste incineration plants (approx. 2 Mt/yr municipal waste)
- special waste incineration plants (more than 500 kt/yr special waste).

Other incineration plants use dry sodium bicarbonate for used tyres, sewage sludge, and hospital waste:

- approx. 35 in France
- 44 in Italy
- others in Germany, Belgium, Portugal and United Kingdom.

The growth in use of dry sodium bicarbonate is of about 10 to 15 new plants each year.

### Reference literature

[59, CEFIC, 2002, 64, TWGComments, 2003]

#### 4.4.3.6 Addition of wet scrubbing as a flue-gas polishing system after other FGT processes

##### Description

It is possible to consider that the addition of a final wet flue-gas treatment system is a polishing treatment after other systems that deal with acid gases etc. This addition is generally made to control HCl and SO<sub>2</sub> emissions where they are high or variable. [74, TWGComments, 2004]

##### Achieved environmental benefits

Further reliability in reduction of acid gases (HCl, HF, SO<sub>2</sub>) emissions to air to levels at the lower end of the ranges are shown in 4.4.3.1.

##### Cross-media effects

See Section 4.4.3.1.

##### Operational data

See Section 4.4.3.1.

##### Applicability

See Section 4.4.3.1.

Mainly applied at existing plants where emissions of acid gases are high or variable and there is a desire to control these to a lower level. Most suited to wastes that have high and variable concentration of chlorine or other acid forming components (e.g. hazardous wastes or MW that includes industrial wastes).

**Economics**

See Section 4.4.3.1. Because in this case the consideration is of the addition of a further polishing stage, the additional costs incurred will be significant.

**Driving force for implementation**

See Section 4.4.3.1 for driving forces respects the use of wet FGT in general.

**Example plants**

Information not supplied.

**Reference literature**

[64, TWGComments, 2003]

**4.4.3.7 Recirculation of FGT residues in the FGT system****Description**

Residues collected in the bag filters used for dry, semi-wet and similar (but not wet) FGT (see also Sections 4.4.3.2, 4.4.3.3, 4.4.3.4) systems usually contain a significant proportion of unreacted flue-gas treatment reagents, as well as the fly ash and other pollutants removed from the gas stream. A proportion of the accumulated residues can be recirculated within the FGT system.

Because of the re-circulation the size of the FGT is generally increased to accommodate the additional volume of re-circulating material.

**Achieved environmental benefits**

The re-circulation of reagents within the system has the following advantages:

- reduced reagent consumption (cf. dry and semi-wet systems)
- reduced solid residue production (contains less un-reacted reagent).

Reduction of emissions to air are similar to those already shown in Section 4.4.3.3

**Cross-media effects**

For this technique, the most significant cross-media effects are:

- production of solid residues (although less than without recirculation)
- energy consumption from use of the bag filter.

In some cases increases in Hg releases have been reported. Consideration of the Hg input rates and the provision of sufficient Hg removal may therefore be required to control this.

**Operational data**

Criteria	Description of factors affecting criteria	Evaluation (high/medium/low)	Comment
<b>Complexity</b>	<ul style="list-style-type: none"> <li>• additional process units required</li> <li>• critical operational aspects</li> </ul>	H/M	<ul style="list-style-type: none"> <li>• care required to ensure effective circulation of reagent and humidity control</li> </ul>
<b>Flexibility</b>	<ul style="list-style-type: none"> <li>• ability of technique to operate under range of input conditions</li> </ul>	H/M	<ul style="list-style-type: none"> <li>• large buffer volume of circulating reagent increases flexibility</li> <li>• not as flexible in respect of inlet variations as wet systems</li> </ul>
<b>Skills required</b>	<ul style="list-style-type: none"> <li>• notable extra training or manning requirements</li> </ul>	M/L	

**Table 4.53: Operational data associated with the use of residue re-circulation**  
[57, Alstom, 2003] [64, TWGComments, 2003]

Reagent injection and residue bleed rates require optimisation to prevent adsorbent loading and eventual substance breakthrough (e.g. Hg and PCDD/F adsorbed on carbon).

Moisture levels require monitoring and control to maintain acid gas adsorption efficiency.

Upstream HCl monitoring may be used to optimise alkaline reagent/water dose rates.

Some parts of the FGT system volume must be larger to incorporate the additionally re-circulated material.

### Applicability

The applicability of this technique is assessed in the table below:

Criteria	Evaluation/comment
Waste type	<ul style="list-style-type: none"><li>all waste types except where inlet concentrations are highly variable e.g. merchant hazardous wastes, unless in combination with another system for these pollutants</li><li>currently applied to: MSW, RDF, wood wastes</li></ul>
Plant size range	<ul style="list-style-type: none"><li>no restriction</li></ul>
New/existing	<ul style="list-style-type: none"><li>no specific restrictions</li><li>filter need to be larger than other systems to accommodate re-circulated</li></ul>
Inter-process compatibility	<ul style="list-style-type: none"><li>compatible with FGT systems other than wet systems</li></ul>
Key location factors	<ul style="list-style-type: none"><li>space required for larger reactor</li></ul>

**Table 4.54: Assessment of the applicability of residue re-circulation**  
[57, Alstom, 2003], [64, TWGComments, 2003]

An alternative to this technique, that also reduces reagent use and residue production, is the use of efficient *once-through* systems. That is, those where the installation designed and operation is such that the reagents used are already largely reacted (i.e. little unreacted reagent remains) without re-circulation. Analyses of the FGT residues may be carried out to determine the proportions of reacted and unreacted reagent.

### Economics

Bag filter size and cost increased owing to larger capacity required for the re-circulation of residues.

Revenue costs are reduced by lower reagent consumption (improved stoichiometric ratio cf. dry systems) and reduced residue disposal costs.

### Driving force for implementation

This technique has been implemented where:

- reagent consumption requires specific reduction
- residue production requires reduction.

### Example plants

Existing processes in: Sweden, Norway, Germany, Denmark and Spain.

### Reference literature

[57, Alstom, 2003], [64, TWGComments, 2003]

#### 4.4.3.8 Direct addition of alkaline reagents to the waste (direct desulphurisation)

##### Description

This technique has already been described in Section 2.5.4.2. It is generally only applied to fluidised bed furnaces.

The alkaline reagent reacts in the furnace with acid gases to reduce the raw gas acid loads passing to subsequent flue-gas cleaning stages.

Adsorption within the furnace at high temperatures is much more effective for SO<sub>2</sub> than for HCl; the main applications are therefore processes with relatively high SO<sub>2</sub> content, e.g. sludge incineration.

[74, TWGComments, 2004]

##### Achieved environmental benefits

Some reduction of raw gas loads and reduction of emissions and consumptions associated with FGT later in the process.

##### Cross-media effects

For this technique the most significant cross-media effects are:

- consumption of reagents in the furnace
- effects on the bottom ash quality since salts and the excess reagent are mixed with it
- changing the composition of the flue-gas (SO<sub>2</sub>/HCl ratio) can affect the performance of downstream FGT systems, can alter the PCDD/F profile and can cause corrosion problems in the FGT.

The addition of lime will not only affect bottom ash quality, but also the composition and resistivity of the fly ash (i.e. there will be more Ca and more sulphurous compounds and higher dilution of pollutants with increasing amount of FGT residues) [64, TWGComments, 2003]

##### Operational data

The main advantage of this technique is that it may reduce corrosion problems in the boiler. As the stoichiometric ratio is quite high it does not improve the overall FGT performances [64, TWGComments, 2003]

##### Applicability

Only applicable to fluidised bed systems.

##### Economics

The reduced flue-gas treatment costs need to be considered against the costs of adding the reagent at the earlier stage.

Additional capital costs for the provision of reagent injection into the furnace/waste.

##### Driving force for implementation

Implemented as a retrofit at existing plants where there is only limited capacity to increase the acid gas cleaning capacity of the FGT systems.

##### Example plants

Information not supplied.

##### Reference literature

[1, UBA, 2001] [64, TWGComments, 2003]

### 4.4.3.9 Use of acid gas monitoring for FGT process optimisation

#### Description

By using fast response gas HCl monitoring upstream and/or downstream of dry and semi-wet FGT systems, it is possible to adjust the operation of the FGT system so that the quantity of alkaline reagent used is optimised for the emission set point of the operation. The technique is generally applied as an additional method to control peak concentrations, with the build up of a layer of reagent on the bag filters also providing an important buffering effect for reagent fluctuations.

This technique is not relevant to wet scrubbers as the scrubbing medium is water and the supply of water to a wet scrubber is controlled by the evaporation and bleed rates, not by the raw HCl concentration. [64, TWGComments, 2003]

SO<sub>2</sub> measurement is sometimes also carried out [64, TWGComments, 2003]. However, just preventing HCl breakthrough may assist in ensuring that sufficient reagent is available to also provide for SO<sub>2</sub> control and, therefore, reduce such peak emissions.

#### Achieved environmental benefits

- peak raw gas loads are anticipated and therefore do not result in elevated emissions to air
- neutralisation reagent consumption can be reduced by matching the demand
- reduction in amount of unused reagent in residues.

#### Cross-media effects

No significant effects.

#### Operational data

The response time of the monitor needs to be fast to pass the control signal to the reagent dosing equipment in time to provide an effective response.

Corrosion resistance of the monitors is essential as they are located in an extremely aggressive environment. Fouling can also be a problem.

The variation in the dosing of absorption capacity in the FGT device can be made by:

- changing the flowrate using variable speed pumps or variable speed dosing screws
- changing the concentration of reagent in semi-wet systems - when smaller mixing tank volumes improve the rate of change of concentration.

#### Applicability

The applicability of this technique is assessed in the table below:

Criteria	Evaluation/comment
Waste type	Particularly suited to dry, semi-wet and intermediate FGT processes with high variability inlet concentrations of acid gases
Plant size range	Smaller plants may benefit the most as rogue waste inputs can exert larger influence on smaller throughput systems.
New/existing	Suited to new and existing processes but particularly suited to retrofits where acid gas control could be further optimised.
Inter-process compatibility	Mainly applicable to dry and semi-wet systems.
Key location factors	No significant issues

Table 4.55: Assessment of the applicability of raw gas monitoring for optimisation of FGT



This technique is not generally necessary for processes with wet scrubbers owing to their greater flexibility with respect to inlet concentrations of HCl.

Less applicable where wastes are homogenised and well quality controlled by means of selection, mixing or pretreatment operations. Most applicable where waste quality control at the input to the furnace is limited.

### Economics

Information not supplied.

### Driving force for implementation

The technique has been applied as a retrofit at existing plants where excesses of short-term emission limits have occurred.

The technique has also been included in the design for new processes.

### Example plants

Applied at some incinerators in the UK and France.

### Reference literature

[17, ONYX, 2000] [64, TWGComments, 2003]

## 4.4.4 Reduction in the emissions of nitrogen oxides

Primary measures are generally of great importance for reducing the formation of NO<sub>x</sub> at the combustion stage. These have been described earlier in this document (see 4.1 and 4.2). They mainly relate to the management and preparation of wastes, and particularly to the thermal treatment techniques applied. This section of the BREF deals with the techniques that are applied for the reduction of NO<sub>x</sub> emissions by the application of secondary (abatement) techniques. In general, combinations of primary and secondary techniques are applied.

### 4.4.4.1 Selective catalytic reduction (SCR)

#### Description

This techniques has already been described in Section 2.5.5

The most common SCR reactions, which are catalysed, are:

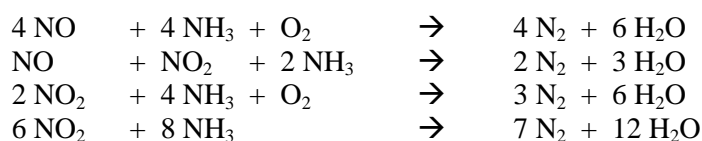

In waste incineration, SCR is generally applied after dedusting and acid gas cleaning (examples of the high dust/dirty gas use of this technique are rare). This being the case, flue-gases usually require reheating after the earlier FGT stages (usually the FGT exit temperature is 70 °C for wet systems and 120 – 180 °C for most bag filters) to reach the operational temperature for the SCR system (see below). The location of the SCR directly after a hot dedusting system, is not common but is used at some plants across Europe, can avoid the disadvantages of any reheating of the flue-gases along the whole FGT line. [74, TWGComments, 2004]

Operational temperature ranges for SCR systems are reported [64, TWGComments, 2003] to range from 180 – 450 °C. However, it is most common for systems to operate in the range 230 - 320 °C. The lowest operational temperatures generally require cleaner flue-gases at the SCR inlet. SO<sub>2</sub> concentration in the flue-gases may be critical as they can result in poisoning of the catalyst.

The catalyst material generally consists of the carrier ( $\text{TiO}_2$ ) with added active substances ( $\text{V}_2\text{O}_5$  and  $\text{WO}_3$ ).

### Achieved environmental benefits

Reduction of emissions to air - generally as follows:

Substance(s)	Reduction efficiency range (%)	Achieved emission ranges				Comments
		½ hour average (mg/Nm <sup>3</sup> )	daily average (mg/Nm <sup>3</sup> )	Annual average (mg/Nm <sup>3</sup> )	Specific emission (kg/t waste input)	
$\text{NO}_x$	>80 %	15 – 220	15 – 100	15 – 100	0.15 – 0.60	
$\text{NH}_3$	n/a		<10			
$\text{N}_2\text{O}$	n/a					Not supplied

**Table 4.56: Emission levels associated with the use of SCR**

Source [1, UBA, 2001, 2, infomil, 2002, 13, JRC(IoE), 2001, 60, Reimann, 2002]

In addition, if specifically designed (extra catalyst layer, higher operational temperature) SCR can also catalytically destroy PCDD/F (see 4.4.5.3). Destruction efficiencies of 98 – 99.9 % are seen, giving PCDD/F emissions in the range of 0.05 – 0.002 ng/Nm<sup>3</sup> TEQ.

The application of SCR generally results in lower  $\text{NO}_x$  emissions than other techniques. The main disadvantages are its higher capital cost, and the consumption of energy (usually natural gas, light oil or high pressure steam) that is required to support the reheat of flue-gases to the catalyst reaction temperature. The selection of systems that operate effectively at the lower end of this temperature range and the use of heat exchange reduces the additional energy requirement.

### Cross-media effects

For this technique the most significant cross-media effect is the energy requirement for flue-gas heating. However the magnitude of this can be reduced if the operating temperature of catalyst is low. However, in such cases catalyst regeneration (this is usually off site) then requires additional energy to regenerate catalyst by sublimation of salt generated. [74, TWGComments, 2004]

Reheat energy demand (and cost) is generally greatly reduced by the use of a heat exchanger that uses the heat from the SCR exhaust to heat the SCR inlet. Energy losses, and hence additional demand, are then reduced to heat exchange and radiant losses. In cases where a demand exists for medium hot water, further economies may be made by installing an additional heat exchanger for the recovery of the SCR outlet energy for supply. Such a system has been used at SYSAV, Malmö, Sweden. [64, TWGComments, 2003]

The two diagrams below show the application of SCR downstream of non-wet (i.e. dry or semi-dry) FGT and wet FGT systems. The temperature profiles are given. It may be seen that the second system (with the wet FGT) in this case includes an additional heat exchange step. Such a set-up reduces the requirement for additional energy input, but results in a colder final flue-gas discharge. Colder final stack discharge may require special measures to prevent stack corrosion and is likely to increase plume visibility.

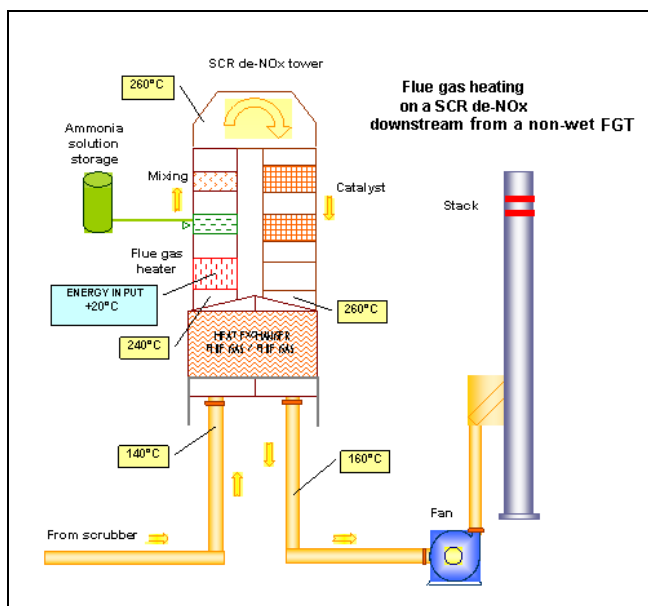

Figure 4.7: Diagram of an SCR system downstream of non-wet FGT showing typical heat exchange and temperature profiles

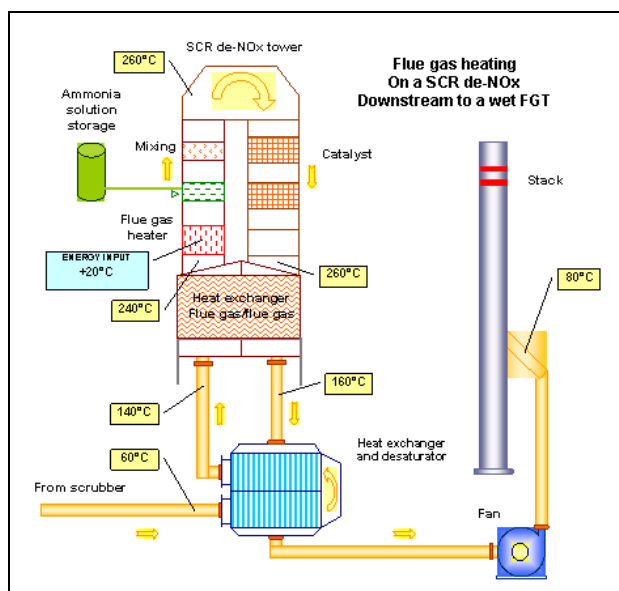

Figure 4.8: Diagram of an SCR system downstream of a wet FGT system showing additional heat exchange and temperature profiles

Reagent (usually ammonia solution) consumption rates are lower with this technique than with SNCR.

Cross-media effects are identified in the table below:

Criteria	Units	Range of values	Comments
Energy requirements	kWh/t waste input	65 – 100 thermal 10 – 15 electrical	Thermal relates to reheating, electrical to the additional pressure drop across the catalyst
Reagent consumption	kg/t waste input	3.2 (3.6l)	25 % ammonia solution
Reagent stoichiometry	ratio	1 – 1.1	Figure relates to input pollutant concentration.
Residue - type			Spent catalyst when changed
Residue - amount	kg/t waste input	0.01	
Water consumption	l/t waste input		not significant
Effluent production	l/t waste input		none
Plume visibility impact	+/-	-	Reduced due to reheat applied with SCR
Note: the data in this table aims to provide the typical operational range. The precise amounts of residues and effluents produced will depend on many factors including raw gas concentrations (waste related), flowrates, reagent concentrations etc.			

**Table 4.57: Cross-media effects associated with the use of SCR**  
[1, UBA, 2001, 2, infomil, 2002, 13, JRC(IoE), 2001, 60, Reimann, 2002] [74, TWGComments, 2004]

### Operational data

Criteria	Description of factors affecting criteria	Evaluation (high/medium/low) or data	Comment
Complexity	<ul style="list-style-type: none"> <li>additional process units required</li> <li>critical operational aspects</li> </ul>	H	Additional process unit required
Flexibility	<ul style="list-style-type: none"> <li>ability of technique to operate under range of input conditions</li> </ul>	H	High reduction rates generally achieved Sensitive to SO <sub>2</sub> , SO <sub>3</sub> and P inlet concentrations. Multifunctional NO <sub>x</sub> and PCDD/F reduction
Skill requirements	<ul style="list-style-type: none"> <li>notable extra training or manning requirements</li> </ul>	H/M	

**Table 4.58: Operational data associated with the use of SCR**

The temperature of the catalyst has an important effect on the (relative speed of) reactions. The optimum temperature range for catalytic reduction depends upon the type of catalyst used, but is commonly between 200 and 350 °C. Other types of catalysts have lower optimal temperatures. [2, infomil, 2002] [64, TWGComments, 2003]

Generally, a lower operational catalyst temperature results in a slower reaction rate (NO reduction rates are slowed relatively more by lower temperatures than NO<sub>2</sub> rates) and possible ammonia slippage. A higher temperature results in a shortened catalyst lifetime and can lead to the oxidation of NH<sub>3</sub>, and the production of additional NO<sub>x</sub> [2, infomil, 2002].

Lower temperature SCR systems are generally less effective for PCDD/F destruction and additional catalyst layers may be required. Lower temperature systems generally require cleaner inlet flue-gases – with low SO<sub>2</sub> values of particular interest. [64, TWGComments, 2003]

The low operating temperature SCR requires an automatic cleaning device (e.g. air soot blower) Regular regeneration is required to remove ensure ammonia salts. Frequency of regeneration with lower temperature systems may be as high as every 1000h. At such frequency this may become operationally critical as it can lead to elevated pollutant levels in the final flue-gas for HCl and SO<sub>2</sub>.  
[74, TWGComments, 2004]

The achieved environmental benefits may depend on the positioning gin the overall FGT system. Where the SCR is before the scrubber, the NO<sub>x</sub> reduction efficiency may be reduced, leading to emission values for NO<sub>x</sub> above those presented in Table 4.47.  
[74, TWGComments, 2004]

#### Catalysts:

[2, infomil, 2002] Criteria for determining the type of catalyst to be used are:

- flue-gas temperature
- NO<sub>x</sub> reduction required
- permissible ammonia slip
- permissible oxidation of sulphur dioxide
- concentration of pollutants
- lifetime of the catalyst
- requirement for additional gaseous PCCD/F destruction
- dust concentration in flue-gas.

[74, TWGComments, 2004]

The following types of degradation limit the lifetime of catalysts:

- poisoning: where the active site of the catalyst is blocked by a strongly bound compound
- deposition: where pores are blocked by small particles or condensed salts, such as ammonium bisulphate (NH<sub>4</sub>HSO<sub>4</sub>) – this can be reduced by SO<sub>x</sub> reduction at inlet and may be partially reversible by reheating the catalyst
- sintering: where at too high temperatures the microstructure of the catalyst is destroyed
- erosion: due to physical damage caused by solids and particles.

Lifetimes of three to five years are reported for catalysts.

Droplets at the outlet of scrubber system which cause salt deposition are considered a critical factor that increases catalyst degradation rate.

Note: The *catalyst lifetime* is the number of hours until the catalyst can no longer provide the required NO<sub>x</sub> reduction without exceeding an agreed maximum NH<sub>3</sub> slip. Consequently, when deciding to apply the SCR technique, both a NO<sub>x</sub> and an NH<sub>3</sub> emission limit value must be guaranteed.

### Applicability

The applicability of this technique is assessed in the table below:

Criteria	Evaluation/comment
<b>Waste type</b>	<ul style="list-style-type: none"> <li>can be applied to any waste type</li> </ul>
<b>Plant size range</b>	<ul style="list-style-type: none"> <li>can be applied to any size plant but most often to medium to larger plants for economic reasons</li> </ul>
<b>New/existing</b>	<ul style="list-style-type: none"> <li>often a tail-end process that can be applied to new or existing processes</li> </ul>
<b>Inter-process compatibility</b>	<ul style="list-style-type: none"> <li>mostly requires pre-dedusting of the flue-gas and may also require SO<sub>2</sub>/SO<sub>3</sub> removal. HCl removal may also be required.</li> <li>minimum inlet temperature required for operation</li> <li>use of SCR can allow lowering of NO<sub>x</sub> emissions without additional techniques if lower ELVs applied</li> </ul>
<b>Key location factors</b>	<ul style="list-style-type: none"> <li>locations with high NO<sub>x</sub> sensitivity may benefit from additional NO<sub>x</sub> reductions achievable with this technique</li> <li>space is required on site for the additional process unit</li> </ul>

**Table 4.59: Assessment of the applicability of SCR**

### Economics

Capital cost information for the technique is shown in the table below:

FGT component(s)	Estimated investment cost (EUR million)	Comments
<b>Fabric filter</b>	2	
<b>Spray dryer</b>	1 – 1.5	
<b>SNCR/evaporation cooler/reagent injection/fabric filter</b>	7	Example of typical combination
<b>Evap. cooler/reagent injection/fabric filter/SCR</b>	10	Example of typical combination
Costs estimated related to a 2 line MSWI of total capacity 200K t/yr		

**Table 4.60: Estimated investment costs of selected components of typical semi-wet FGT systems using SCR and SNCR**  
[12, Achternbosch, 2002]

Table 4.60 above shows, for the plant described (both using semi-wet technology), an increased investment cost when using SCR instead of SNCR in the order of EUR 3 million.

Investment costs for SCR for a two line 200000 t/yr MSWI are estimated as EUR 4 million. This compares with around EUR 1 million for SNCR. [12, Achternbosch, 2002].

Recent De NO<sub>x</sub> study shows that capital cost for SCR unit for a plant of 15 t/h (i.e. 100 000 t/y) is in the range of EUR 7.5 to 9.5 million. [74, TWGComments, 2004]

[2, Infomil, 2002] The operating costs of removing one tonne of NO<sub>x</sub> ranges between EUR 1000 and EUR 4500, with a trend for costs decreasing. If this cost is allocated to the processing costs per tonne of waste, this corresponds to EUR 5 to EUR 7.7. SNCR operational costs are in general 25 – 40 % lower than SCR (depending on reagent for SNCR, temperature for SCR, preheating etc.). [13, JRC(IoE), 2001] [74, TWGComments, 2004]

Large plants with higher gas flowrates and economies of scale are more able to support the additional cost burden of SCR, as the cost will be distributed over a greater quantity of waste.

High pressure steam can be used for the SCR reheat. At installations where low incomes are received for this energy (either as heat or when converted into electricity) its use for reheat involves a lower income loss (i.e. cost) than where higher revenues are received. It follows then that SCR operational costs can, therefore, be effectively lower at those plants that receive lower fees for the mid and high pressure fraction of the energy.

Example: New MSWI line in Southern Sweden 2002/3:

The capital cost of SCR for a new MSWI line (2002 price) of 25 t/hr (gas flow approx. 150000 m<sup>3</sup>/h) was estimated at EUR 5 – 7 million. There is some uncertainty in this cost because the SCR was purchased as part of an overall FGT package.

For this example, the cost structure for deciding to use SCR was derived from the following calculations:

Avoided expenditure:

NO<sub>x</sub> tax avoided through reduced emissions (such taxes are applied in Sweden at a rate of approximately 4500 EUR/t NO<sub>x</sub>).

The destruction of gaseous PCDD/may mean that there are economies on other measures for PCDD/F control (see Section 4.4.5.3) [74, TWGComments, 2004]

Costs incurred:

Financing of higher SCR capital investment + lost income from heat/steam used for SCR that would otherwise be sold + any additional reagent consumption or catalyst replacement costs.

**Driving force for implementation**

This technique has been implemented where:

- permit values for NO<sub>x</sub> are set below 100 mg/Nm<sup>3</sup>
- large plants have been identified as significant local NO<sub>x</sub> contributors
- NO<sub>x</sub> taxes are set at a level that make the technique economically favourable
- high pressure steam is available for the flue-gas reheating (this reduces operational costs when low incomes are received for the energy produced).

**Example plants**

SCR is widely used in the incineration industry. There are examples in D, A, NL, B, Japan and elsewhere.

Data provided by FEAD show that at least 43 of approx. 200 European MSWI plants surveyed use SCR.

SCR is also applied to merchant and industrial HWIs, particularly in Germany.

**Reference literature**

[1, UBA, 2001, 2, infomil, 2002, 3, Austria, 2002, 13, JRC(IoE), 2001, 60, Reimann, 2002, 61, SYSAV, 2002] [64, TWGComments, 2003]

**4.4.4.2 Selective non-catalytic reduction (SNCR)****Description**

This technique has already been described in Section 2.5.5.2.1

[2, infomil, 2002] In the SNCR process, ammonia (NH<sub>3</sub>) or urea (CO(NH<sub>2</sub>)<sub>2</sub>) is injected into the furnace to reduce NO<sub>x</sub> emissions. The NH<sub>3</sub> reacts most effectively with NO<sub>x</sub> between 850 and 950 °C, although temperatures of up to 1050 °C are effective when urea is used. If the temperature is too high, a competing oxidation reaction generates unwanted NO<sub>x</sub>. If the temperature is too low, or the residence time for the reaction between NH<sub>3</sub> and NO<sub>x</sub> is insufficient, the efficiency of NO<sub>x</sub> reduction decreases, and the emission of residual ammonia can increase. This is known as *NH<sub>3</sub> slip*. Some ammonia slip will always occur because of reaction chemistry. Additional NH<sub>3</sub> slip can be caused by excess or poorly optimised reagent injection. [74, TWGComments, 2004]

**Achieved environmental benefits**

Reduction of emissions to air as follows:

Substance(s)	Reduction efficiency range (%)	Achieved emission ranges				Comments
		½ hour average (mg/Nm <sup>3</sup> )	24 hour average (mg/Nm <sup>3</sup> )	Annual average (mg/Nm <sup>3</sup> )	Specific emission (g/t waste input)	
NO <sub>x</sub>	30 – 75 %	150 – 400	80 - 180	70 - 180	0.4 – 1.2	Varies with dosing rate, waste and combustor type
NH <sub>3</sub>	n/a		5 - 30			Lowest where wet scrubbers used. See notes in this table below.
N <sub>2</sub> O	n/a		10 - 30			See notes below in this table
Notes: N <sub>2</sub> O emissions increase rapidly with higher reagent dose rates required to achieve NO <sub>x</sub> below 120 mg/Nm <sup>3</sup> The N <sub>2</sub> O emissions depend on reaction (furnace) temperature and on reagent. Generally higher N <sub>2</sub> O emissions are attained with urea than with ammonia. With urea the N <sub>2</sub> O emissions can be higher. To achieve higher NO <sub>x</sub> % reduction efficiencies higher reagent dose rates are required which may lead to higher NH <sub>3</sub> slip – with downstream wet FGT the NH <sub>3</sub> may then be absorbed but measures are then required to deal with its presence in the waste water e.g. NH <sub>3</sub> stripping.						

**Table 4.61: Emission levels associated with the use of SNCR**

[1, UBA, 2001, 2, infomil, 2002, 3, Austria, 2002, 12, Achternbosch, 2002, 60, Reimann, 2002]

The main source of N<sub>2</sub>O emissions in SNCR is utilisation of urea instead of ammonia (leading to 2 - 2.5 times higher N<sub>2</sub>O emission than in the case of reduction by ammonia). To reduce N<sub>2</sub>O formation, it is therefore important to optimise the reactant choice (ammonia or urea) and to control process conditions (especially gas mixing, temperature and ammonia slip) [64, TWGComments, 2003]

It has been reported that application of SNCR may also reduce PCDD/F formation (although quantitative evidence of this has not been provided) [64, TWGComments, 2003]

**Cross-media effects**

Cross-media effects are identified in the table below:

Criteria	Units	Range of achieved values	Comments
Energy requirements	kWh/t waste input	45 – 50 thermal	cooling effect of in-furnace injection
Reagent consumption	kg/t waste input	8.5 (9.5 l)	25 % ammonia solution
Reagent stoichiometry	ratio	2 – 3	
Residue - type			None
Residue - amount	kg/t waste input		None
Water consumption	l/t waste input		Not significant
Effluent production	l/t waste input		None
Plume visibility	+/-	0	No significant effect

**Table 4.62: Cross-media effects associated with the use of SNCR**

[60, Reimann, 2002]

For this technique the most significant cross-media aspects are:

- energy consumption (lower than SCR)
- possible production of N<sub>2</sub>O (high global warming potential) and ammonia slip if the SNCR process is not well controlled
- consumption of reagent (higher than SCR)
- ammonia slip can contaminate residues and waste water; recovery of ammonia is possible.



In lime-based semi-dry, intermediate and dry FGT systems, the  $\text{NH}_3$  slip is absorbed by the  $\text{CaCl}_2$  formed from the removal of  $\text{HCl}$ . If this residue is subsequently exposed to water, the  $\text{NH}_3$  will be liberated. This can have consequences in respect of downstream residue treatment or cement stabilisation.

Ammonia stripper may be needed with wet systems to comply with local effluent discharge standards or in order to ensure adequate precipitation of e.g. Cd and Ni from the process waste water. The addition of such a process adds operational complexity and cost.

### Operational data

Criteria	Description of factors affecting criteria	Evaluation (high/medium/low) or data	Comment
<b>Complexity</b>	<ul style="list-style-type: none"> <li>additional process units required</li> <li>critical operational aspects</li> </ul>	M	<ul style="list-style-type: none"> <li>reagent injection equipment required but not separate reactors (cf. SCR)</li> <li>temperature and reagent injection optimisation important</li> </ul>
<b>Flexibility</b>	<ul style="list-style-type: none"> <li>ability of technique to operate under range of input conditions</li> </ul>	M	<ul style="list-style-type: none"> <li>good <math>\text{NO}_x</math> reduction across range of inlet concentrations</li> <li>temperature critical</li> </ul>
<b>Skill requirements</b>	<ul style="list-style-type: none"> <li>notable extra training or manning requirements</li> </ul>	M	<ul style="list-style-type: none"> <li>care required to control and optimise injection rates</li> </ul>

**Table 4.63: Operational data associated with the use of SNCR**

[64, TWGComments, 2003]

The main factors influencing performance are:

- the mixing of the reactants with the exhaust gases
- the temperature and
- the residence time in the appropriate temperature window.

Increasing the reagent dose rates generally results in decreased  $\text{NO}_x$  emissions. However, this can increase ammonia slip and  $\text{N}_2\text{O}$  emissions (particularly with urea).

The ammonia slip is absorbed if wet scrubbers are used. It can also be removed from the effluent stream using an ammonia stripper – although this adds complexity to the operation, and increases capital and operating costs [74, TWGComments, 2004] The regenerated ammonia can then be used as feedstock for the SNCR process (see also comment under cross-media effect regarding effluent discharges if made).

Generally,  $\text{N}_2\text{O}$  concentrations increase as  $\text{NO}_x$  concentrations decrease. Under unfavourable conditions, levels of over  $50 \text{ mg/m}^3$  can be reached, whereas under favourable conditions, emission concentration levels are below  $10 \text{ mg/m}^3$ . To reduce  $\text{N}_2\text{O}$  formation, it is therefore important to optimise and control process conditions.

The amount of injected  $\text{NH}_3$  depends on the raw gas  $\text{NO}_x$  concentration, as well as on the required  $\text{NO}_x$  reduction. The  $\text{NH}_3$  is introduced into the flue-gas by injection of an aqueous ammonia solution. The most commonly used solutions are (concentrated or diluted) caustic ammonia ( $\text{NH}_4\text{OH}$ ) or urea ( $\text{CO}(\text{NH}_2)_2$ ). The use of urea is effective for relatively small units, as urea can be stored as a solid (in bags) and the storage of ammonia (including the related safety provisions) is not then required. For larger unit, the use of ammonia is generally more effective.

Effective mixing of reagents and the NO<sub>x</sub> in the flue-gas at the optimum temperature is essential to reach a high NO<sub>x</sub> removal efficiency. In order to meet optimum temperature and to compensate for fluctuations in temperature, several sets of injector nozzles can be installed at different levels in the furnace, commonly in the first pass.

In principle, SNCR can be applied where a temperature window is available in the range of 850 to 1050 °C. In most waste incineration plants, this window occurs in the upper part of the furnace.

SNCR systems perform best under steady operating conditions (equal ammonia-distribution and NO<sub>x</sub> concentration). When operating conditions are not steady, ammonia slip (excessive ammonia emission), inadequate NO<sub>x</sub> treatment, or N<sub>2</sub>O formation can occur.

**Applicability**

The applicability of this technique is assessed in the table below:

Criteria	Evaluation/comment
Waste type	Any
Plant size range	Any
New/existing	Locating injection points may be problematic in some existing plants
Inter-process compatibility	Higher dose rates (and hence lower NO <sub>x</sub> emissions) may be used without ammonia slip when used with downstream wet scrubbing (which absorbs the excess ammonia). In such cases an ammonia stripper may be required to reduce NH <sub>3</sub> levels in effluent – stripped NH <sub>3</sub> can be re-fed to the SNCR injection.

**Table 4.64: Assessment of the applicability of SNCR**

The normal maximum reduction efficiency of the technique is approx 75 %. It is therefore not common for SNCR to be used where higher percentage reductions are required, typically this may align with NO<sub>x</sub> emission levels of below 100 mg/Nm<sup>3</sup> (daily average). The higher reagent dose rates required to achieve reduction rates of above 75 % means that achieving ammonia slip of <10 mg/Nm<sup>3</sup>, may require the use of additional measures such as the use of downstream wet scrubbing, and then techniques to control ammonia levels in the effluent may also be required e.g. stripping. [74, TWGComments, 2004]

**Economics**

The key aspects of this technique are:

- capital costs are significantly lower than with SCR (see Table 4.60)
- if an ammonia stripper is added the capital costs are still 10 – 30 % lower than SCR
- reagent consumption costs are higher than SCR
- operating costs are lower than SCR, mainly due to reduced energy requirements for flue-gas reheating.

Investment costs for SNCR for a two line 200000 t/yr. MSWI are estimated as EUR 1 million. This compares with around EUR 4 million for SCR. [12, Achternbosch, 2002]

**Driving force for implementation**

This technique has been implemented where:

- permit ELVs are set between 100 and 200 mg/Nm<sup>3</sup> daily average
- space is not available for SCR
- suitable locations are available for reagent injection (including temperature requirements).

If a discharge of ammonia rich effluent is permissible the use of this technique with a wet FGT system will be more economical as there will be no requirement for an ammonia stripper. This does not apply to other FGT systems that do not produce effluents.

### Example plants

Widely applied throughout Europe.

### Reference literature

[1, UBA, 2001, 2, infomil, 2002, 3, Austria, 2002, 12, Achternbosch, 2002, 60, Reimann, 2002] [64, TWGComments, 2003]

#### 4.4.4.3 Optimisation of reagent selection for SNCR NO<sub>x</sub> reduction

##### Description

The reagents used for SNCR are ammonia and urea. The advantages and disadvantages of their selection are outlined in the table below. The reagent selection needs to take account of a variety of process operational, cost and performance factors to ensure that the optimal one is selected for the installation concerned.

Reagent	Advantages	Disadvantages
Ammonia	<ul style="list-style-type: none"> <li>higher peak NO<sub>x</sub> reduction potential (if well optimised)</li> <li>lower N<sub>2</sub>O emissions (10 – 15 mg/Nm<sup>3</sup>)</li> </ul>	<ul style="list-style-type: none"> <li>narrower effective temperature range (850 – 950 °C) therefore greater optimisation is required</li> <li>handling and storage hazards higher</li> <li>higher cost per tonne waste</li> <li>ammonia slip approx. 10 mg/Nm<sup>3</sup></li> <li>odour of residues if in contact with humidity</li> </ul>
Urea	<ul style="list-style-type: none"> <li>effective temperature range wider (540 – 1000C) therefore temperature control less critical</li> <li>lower hazard storage and handling</li> <li>lower cost per tonne waste</li> </ul>	<ul style="list-style-type: none"> <li>lower peak NO<sub>x</sub> reduction potential (cf. ammonia when optimised)</li> <li>higher N<sub>2</sub>O emissions (25 - 35 mg/Nm<sup>3</sup>) and hence GWP</li> <li>ammonia slip approx. 1 mg/Nm<sup>3</sup></li> </ul>
Note: The lower cost of urea is most significant at relatively small plants. For larger plants the higher storage cost of ammonia may be fully compensated by the lower chemical cost.		

**Table 4.65: Advantages and disadvantages of urea and ammonia use for SNCR**  
[62, Tyseley, 2001] [64, TWGComments, 2003]

New processes can be specifically designed to achieve the stable and predictable combustion conditions, and select the optimal injection locations for the reagent, that then allow the benefits of ammonia (i.e. highest peak NO<sub>x</sub> reduction at lowest N<sub>2</sub>O emissions) to be secured. Those existing processes that have stable and well controlled combustion and temperature profiles in the furnace will also be able to maximise this benefit.

Existing processes that experience difficulties in stabilising combustion conditions (e.g. for design, control or waste type reasons) are less likely to be in a position to optimise the reagent injection (location, temperature, mixing) and may therefore benefit from the use of urea. However if temperatures above 1000 °C are anticipated, the N<sub>2</sub>O production rate with urea becomes more significant.

In cases where the advantages and disadvantages are finely balanced, storage and handling hazards may have a greater impact on final reagent selection.

### **Achieved environmental benefits**

Both reagents result in reductions in NO<sub>x</sub> emissions. Selection of the reagent that is best suited to the combustion characteristics of the furnace will result in the most effective emissions reduction, i.e. effective NO<sub>x</sub> reduction with minimal ammonia slip and N<sub>2</sub>O production.

### **Cross-media effects**

Optimising the selection of reagent should result in the optimisation of NO<sub>x</sub> reduction with minimal ammonia slip and N<sub>2</sub>O releases.

### **Operational data**

Obtaining a good understanding of temperature profiles in the combustion chamber is fundamental to the selection of reagent.

The urea/N<sub>2</sub>O reaction is very dependent on temperature, with as much as 18 % of the NO<sub>x</sub> removed appearing as N<sub>2</sub>O at 1000 °C (although negligible at 780 °C).

### **Applicability**

Consideration of the reagent to be used is applicable to all situations where SNCR NO<sub>x</sub> reduction is to be employed.

### **Economics**

Ammonia is reported to be marginally more expensive to use than urea. Handling and storage requirements for ammonia liquid, gas and solutions are generally more stringent and, hence, more expensive than for urea, which can be stored as a solid - this contributes to the cost differential between the two reagents.

Storage of more than 50 tonnes of gaseous ammonia is regulated under COMAH Directive. This may cause extra costs due to requirements of local authorities and permit application procedures. In most cases ammonia is used as a solution. There are still some safety requirements but less stringent than with gaseous or liquefied ammonia.

The lower cost of urea is only valid for relatively small plants. For larger plants the higher storage cost of ammonia may be fully compensated by the lower chemical cost.

### **Driving force for implementation**

Requirements to reduce NO<sub>x</sub> effectively, without excessive release of N<sub>2</sub>O, which has a high greenhouse gas potential (310 times higher than CO<sub>2</sub>).

### **Example plants**

SNCR is widely applied in Europe.

### **Reference literature**

[62, Tyseley, 2001] [64, TWGComments, 2003]

#### **4.4.4.4 Replacement of secondary air with re-circulated flue-gas**

See Section 4.2.12

#### **4.4.5 Reduction of PCDD/F emissions**

For the majority of wastes, it is not possible for waste incinerations to meet the air emission limit values of EC 2000/76 (0.1 ng/Nm<sup>3</sup>) only through the use of primary (i.e. combustion related) measures. Secondary (i.e. abatement) measures are, therefore, necessary. In general achieving such emission levels involves using a combination of: primary techniques, to reduce PCDD/F production with; secondary measures to further reduce the air emission level. [64, TWGComments, 2003]

#### 4.4.5.1 Primary techniques for prevention of PCDD/F

Primary measures are not dealt with in this section (which concerns FGT aspects) but elsewhere as described below.

Main prevention of PCDD/F-formation in waste incinerators is a well controlled combustion process, preventing the formation of precursors. The techniques that are applicable for improving the combustion related aspects that will lead to generally improved incineration performance, including a reduction in the risk of PCDD/F production are dealt with in earlier sections of this chapter. In particular in the following sections:

##### 4.1 General practices applied before the thermal treatment stage

*This section has relevance in that it deals with the control and preparation of the waste before it is incinerated. The improved combustion characteristics and knowledge of the waste that results from the application of these techniques contributes to improving subsequent combustion control and, hence, reduces PCDD/F formation risks.*

##### 4.2 Thermal processing

*As already noted in the paragraph above, well controlled combustion aids the destruction of PCDD/F and its precursors that may already be in the waste and prevents the formation of precursors. The techniques listed in this section, as applicable to the waste/installation concerned, are of key importance for the primary reduction of PCDD/F releases to all media.*

##### 4.3 Energy recovery

*In the energy recovery zones of the incineration installation, the most important concern from a PCDD/F perspective is the prevention of reformation. In particular, the presence of substances and detailed design in the temperature zones that may increase the risk of PCDD/F formation, are of particular importance. The techniques included in the energy recovery section of this chapter include consideration of the PCDD/F aspects.*

Therefore, the sections that follow (i.e. those here in 4.4.5) deal only with PCDD/F aspects that are relevant to the FGT system, with primary measures being considered elsewhere as described above.

[64, TWGComments, 2003]

#### 4.4.5.2 Prevention of reformation of PCDD/F in the FGT system

##### Description

Reducing dust laden gas residence time in the temperature zone 450 to 200 °C reduces the risks of formation of PCDD/F and similar compounds.

If dust removal stages are used in this temperature range the residence time of the fly ash in this range is prolonged, increasing the risk of PCDD/F formation. Dust removal devices in the high dust zones (commonly electrostatic precipitators and some bag filters) operated at temperatures above 200 °C increase the risk of PCDD/F formation. Temperatures at the inlet to the dust removal stage should, therefore, be controlled to below 200 °C. This can be achieved by:

- additional cooling in the boiler (the boiler design in the 450 – 200 °C range should itself limit dust residence to avoid simply transferring the problem upstream)
- addition of a spray tower to reduce temperature from boiler exit to below 200 °C for the subsequent dust cleaning stages
- full quench from combustion temperatures to approx. 70 °C - this is carried out at plants where there is no boiler cooling and usually only where there is an increased dioxin risk owing to the nature of the waste incinerated (e.g. high PCB inputs). Quenching down to 70 °C is common in HWIs operated by the Chemical Industry
- Gas/gas heat exchange may also be implemented (gas from inlet scrubber/gas from outlet scrubber).

[74, TWGComments, 2004]

**Achieved environmental benefits**

Reduced risk of PCDD/F production in the process and, hence, subsequent emissions.

**Cross-media effects**

Existing plants with high temperature dust removal stages may utilise such systems in order to retain heat in the flue-gases so that this heat can subsequently be used for some other purpose e.g. transfer by heat exchange to later flue-gas treatment systems. If the gases are cooled to below 200 °C this may lead to a need for additional heat input to the flue-gas to maintain the required temperature profile for those downstream systems. It may be possible for losses to be reduced by, instead, using the heat removed prior to the dust removal stage for reheat using heat exchange systems.

Full quench systems generally result in limited opportunities for energy recovery (boilers are not generally found where full quench is employed). They also create a very high moisture content plume that increases visibility and condensation, and require large water injection rates to provide sufficient cooling of the hot flue-gases. The waste water produced may be recirculated to some degree, but discharge and water treatment is usually required. Recirculated water may require cooling to prevent loss to the stack and to maintain FGT operation.

**Operational data**

Quench systems employed at some HWIs are reported to effectively eliminate PCDD/F formation. [46, Cleanaway, 2002]

Where heat recovery boilers are used, but dust removal is avoided in the 450 – 200 °C range, raw gas concentrations before dioxin removal/destruction in the range 1 – 30 ng/Nm<sup>3</sup> (TEQ) are seen. Where dust removal is carried out in the 450 – 200 °C range, downstream gas can contain from 10 to >100 ng/Nm<sup>3</sup> PCDD/F (TEQ).

**Applicability**

The applicability of this technique is assessed in the table below:

Criteria	Evaluation/comment
<b>Waste type</b>	Particularly an issue where PCBs or other waste where risks of PCDD/F formation is believed to be higher.
<b>Plant size range</b>	The technique is suitable to all size ranges
<b>New/existing</b>	More difficult to re-design existing processes
<b>Inter-process compatibility</b>	Significant issue concerning temperature
<b>Key location factors</b>	

**Table 4.66: Assessment of the applicability of PCDD/F reformation prevention techniques**

At existing plants such changes will require a detailed reappraisal of the flue-gas treatment process, with particular respect to heat distribution and use.

In existing plants, where solid wastes and flue-gas already go for subsequent treatment that effectively destroy the produced dioxins (e.g. SCR for gas, plus heat treatment for fly ash), the benefit achievable by adopting the technique is reduced.

**Economics**

No significant cost implications for new processes.

Very significant capital investments may be required at some existing processes for the replacement of boiler and flue-gas treatment systems. Investments in the order of EUR 10 – 20 million may be required for such changes.

Operational cost reductions may be seen from:

- sales of additional energy (heat) recovered in boilers
- reduced cost of disposal of lower PCDD/F contaminated solid residues (where adsorption is used)
- reduced dioxin content may have positive impact on FGT downstream: lower activated carbon rate/lower catalyst volume.  
[74, TWGComments, 2004]

#### **Driving force for implementation**

This technique has been implemented where:

- concern exists regarding the possible production of PCDD/F by the process
- concerns exist regarding the PCDD/F concentrations in FGT absorbents requiring disposal
- waste types combusted are high risk for PCDD/F production.

#### **Example plants**

Quench systems are used for two hazardous waste incineration plants in the UK. Low boiler exit temperatures and post boiler gas cooling is widely used in Europe.

#### **Reference literature**

[46, Cleanaway, 2002], [64, TWGComments, 2003], [74, TWGComments, 2004]

### **4.4.5.3 Destruction of PCDD/F using Selective Catalytic Reduction (SCR)**

#### **Description**

SCR systems are primarily used for NO<sub>x</sub> reduction (see description in Section 2.5.5.2.2 and 4.4.4.1). They can also destroy gas phase PCDD/F through catalytic oxidation if large enough. Typically 2 – 3 SCR catalyst layers are required to provide combined NO<sub>x</sub> and PCDD/F reduction.

It is important to note that in waste incineration the majority of airborne PCDD/F is adhered to dust, with the balance being the gas phase PCDD/F. Techniques that remove dust will, therefore, remove the dust carried PCDD/F, whereas SCR (and other catalytic methods) only destroy the smaller proportion in the gas phase. A combination of dust removal plus destruction generally give the lowest overall emissions of PCDD/F to air.

#### **Achieved environmental benefits**

Destruction efficiencies for gas phase PCDD/F of 98 to 99.9 % are seen, giving PCDD/F emissions (in combination with other FGT techniques) below the 0.1 ng/Nm<sup>3</sup> TEQ set in 2000/76/EC, and more often in the range of 0.05 – 0.002 ng/Nm<sup>3</sup> TEQ.

In general, SCR is applied after initial de-dusting. The dust that is removed at the pre-dedusting stage will carry with it the adsorbed PCDD/F (this may be the majority). The residues from the pre-dedusting stage will, therefore, be contaminated with PCDD/F to the same degree whether SCR is applied or not. The destruction benefit of SCR, in respect of the reduction in contamination of FGT residue it provides, is, therefore, limited to cases where further downstream dust polishing is also applied.

Where these FG polishing residues would normally be sent off-site, this results in an overall reduction in the dioxin outputs to all media from the installation. Where the dioxin residues are separately collected (e.g. using carbon) from other FGT residues and re-burned, if allowed, in the installation then the reduction in overall outputs that may be gained by using SCR as an additional destruction method is less significant.

NO<sub>x</sub> is treated in SCR at the same time as PCDD/F to give very low NO<sub>x</sub> releases (see Section 4.4.4.1)

In the few cases where SCR is applied before other FGTs, it must be noted that the non-gas phase (dust adhered) PCDD/F may not be treated in the SCR unit and, therefore, require subsequent dust removal to reduce it.

### Cross-media effects

Cross-media effects are detailed in Section 4.4.4.1

The most significant cross-media aspects are:

- consumption of energy for flue-gas reheating to reach SCR system reaction temperature
- as a destruction technique, the PCDD/F are not transferred to solid residues (as with some adsorption processes).

In general, destruction is favourable to transfer to another media. However, the magnitude of the cross-media benefit associated with the destruction rather than adsorption of PCDD/F will depend on the avoided risk that is associated with the subsequent downstream management of the PCDD/F laden residues.

### Operational data

Operational data is given in Section 4.4.4.1.

Because it is normal for the majority of PCDD/FR to be associated with solid particulate matter, for overall PCDD/F reduction, it is usually important that dust removal techniques, are applied as well as SCR. This is to ensure that dust bound PCDD/F, which would not be destroyed in the SCR unit, is removed from the flue-gases.

While a single catalyst layer may have a dramatic impact on NO<sub>x</sub> greater size is required to ensure effective PCDD/F destruction as well. The higher the number of layers of catalyst, the greater the impact will be on PCDD/F reduction.

### Applicability

The applicability of this technique is assessed in Table 4.68 below:

Criteria	Evaluation/comment
Waste type	<ul style="list-style-type: none"><li>• can be applied to any waste type</li></ul>
Plant size range	<ul style="list-style-type: none"><li>• can be applied to any plant size, but most economical for medium to large size installations due to capital costs</li></ul>
New/existing	<ul style="list-style-type: none"><li>• when applied as a tail-end technique (most common), the system can be added to any process</li><li>• more complex to retrofit as non-tail end</li></ul>
Inter-process compatibility	<ul style="list-style-type: none"><li>• particularly beneficial where substantial reductions in NO<sub>x</sub> are also required</li><li>• reheat of flue-gases usually required to reach SCR operational range</li></ul>
Key location factors	<ul style="list-style-type: none"><li>• space is required for the SCR reactor</li></ul>

Table 4.67: Assessment of the applicability of SCR for PCDD/F removal

### Economics

Costs of the technique are shown in Section 4.4.4.1

### Driving force for implementation

The implementation of this technique is favoured where the combination of high NO<sub>x</sub> reduction and the additional PCDD/F reduction given by SCR is required.



**Example plants**

SCR is widely used in the incineration industry. There are examples Germany, Austria, the Netherlands, Belgium, France, Japan and elsewhere.

Data provided to EIPPCB by FEAD show that at least 43 of approx. 200 European MSWI plants surveyed use SCR, although it is not clear which of these use the technique for PCDD/F destruction as well as NO<sub>x</sub> reduction.

SCR is also applied to merchant HWIs, particularly in Germany.

**Reference literature**

[1, UBA, 2001, 2, infomil, 2002, 3, Austria, 2002, 13, JRC(IoE), 2001, 27, Belgium, 2002, 61, SYSAV, 2002] [64, TWGComments, 2003]

**4.4.5.4 Destruction of PCDD/F using catalytic filter bags****Description**

This technique has already been described in Section 2.5.8.3

**Achieved environmental benefits**

Destruction efficiencies of PCDD/F entering the catalytic filter bags at a MSWI of above 99 % are reported. Emission concentrations of PCDD/F of below 0.02 ng/Nm<sup>3</sup> TEQ resulted from inlet concentrations of 1.9ng/Nm<sup>3</sup>. [27, Belgium, 2002]

The filters also provide for dust removal. In the example given here, the MSWI used an ESP for pre-dedusting and with the addition of the filters gave dust emission levels in the range 0.2 – 0.6 mg/Nm<sup>3</sup>. NO<sub>x</sub> reduction is also reported using these filters [64, TWGComments, 2003]

The total release of dioxins from the installation (to all media) is also reported to be reduced by the destruction, rather than adsorption (with activated carbon). At the same time as reducing air emissions as described above, samples of bag filter hopper dust showed average concentrations reduced from 3659 ng I-TEQ/kg dust (when using activated carbon) to 283 ng I-TEQ/kg dust (using catalytic filter bags).

**Cross-media effects**

For this technique the most significant cross-media effect is the energy consumption from the pressure drop across bag filter (this is similar to any bag filter).

Catalytic filters are generally used as a replacement for other filters. These may already adsorb dioxins by the injection of activated carbon. Where, in the replaced system, it is the injection of activated carbon that also provides for the main absorption of metallic mercury, the removal of the activated carbon may then result in an increase in Hg emissions to air unless alternative techniques for Hg are used.

**Operational data**

Operational matters are similar to other bag filters.

The temperature range in order for the catalytic reaction to occur varies from 180 °C to 260 °C. [27, Belgium, 2002], [74, TWGComments, 2004]

Tests carried out over 21 months on inlet and outlet PCDD/F concentration on a MSWI (without upstream acid gas removal, but with a pre-dedusting ESP) showed the following results:

<b>Number of months of operation</b>	0.25	1.5	3	4.8	8	13	18	21
<b>Inlet PCDD/F ngTEQ/Nm<sup>3</sup></b>	3.4	7	11	10.5	11.9	11.8	8.1	5.9
<b>Outlet PCDD/F ngTEQ/Nm<sup>3</sup></b>	0.01	0.0035	0.005	0.004	0.01	0.011	0.002	0.023
<b>Calculated efficiency</b>	99.7 %	99.9 %	99.9 %	99.9 %	99.9 %	99.9 %	99.9 %	99.6 %

**Table 4.68: Destruction efficiency data for catalytic filter bags over 21 months of operation**  
[27, Belgium, 2002]

The catalytic media does not treat mercury so an additional device is required such as injection of active carbon or similar.

### Applicability

The applicability of this technique is assessed in the table below:

<b>Criteria</b>	<b>Evaluation/comment</b>
<b>Waste type</b>	Any
<b>Plant size range</b>	Any
<b>New/existing</b>	Applicable to both new and existing processes
<b>Inter-process compatibility</b>	Need to consider Hg abatement in addition
<b>Key location factors</b>	None

**Table 4.69: Assessment of the applicability of catalytic bag filters**

### Economics

For a MSWI of two lines with a capacity of 27500 t/yr each, the additional cost of the use of catalytic bag filters was reported as between EUR 2 and 3/t of waste treated. [27, Belgium, 2002]

The key cost aspects of this technique are:

- increased investment cost of the bags compared with non-catalytic bags. The cost of the media is EUR~300/m<sup>2</sup>, other non-catalytic media, e.g. 100 % PTFE=EUR~60/m<sup>2</sup>
- lower investment costs than SCR but with similar destruction efficiencies
- the need to make additional provision for Hg removal.

[74, TWGComments, 2004]

### Driving force for implementation

This technique has been implemented where:

- PCDD/F emissions well below 0.1ng/Nm<sup>3</sup> TEQ are to be achieved
- space for SCR is not available and alternative means of NO<sub>x</sub> reduction is already installed
- alternative means of Hg control is already installed (the catalytic bags do not control Hg).

### Example plants

Several installations in Belgium and France.

### Reference literature

[27, Belgium, 2002] [64, TWGComments, 2003]

#### 4.4.5.5 Destruction of PCDD/F by re-burn of adsorbents

##### Description

This technique has already been described in Section 2.5.8.4

The basic principle is that the PCDD/F residues collected in the FGT system, may in certain circumstances (see notes regarding Hg below), be destroyed by burning them in the incinerator itself, thereby reducing the overall installation output of PCDD/F.

##### Achieved environmental benefits

PCDD/F in solid residues are destroyed in the process rather than being transferred from the installation in the residues.

##### Cross-media effects

There is a risk of metallic mercury re-circulation (and hence emissions) unless the process also contains a means for mercury removal at an adequate rate.

##### Operational data

Care required when handling the contaminated reagents to ensure spillage is avoided and loading to the furnace is at an even rate to ensure the residues are destroyed effectively in the combustion process.

##### Applicability

The applicability of this technique is assessed in the table below:

Criteria	Evaluation/comment
<b>Waste type</b>	Any
<b>Plant size range</b>	Any
<b>New/existing</b>	Can be applied to new and existing plants
<b>Inter-process compatibility</b>	Mainly only suited to residues from specific PCDD/F dioxin absorption stages (e.g. static coke beds and wet scrubber dioxin absorber inserts) where there are other provisions to avoid mercury build up and potential release.
<b>Key location factors</b>	None

Table 4.70: Assessment of the applicability of re-burn of adsorbents

##### Economics

Investment costs are not generally required unless additional systems for mercury removal are required, when these additions can be significant.

Operational cost savings can be made by reducing the disposal costs of the PCDD/F contaminated residues.

##### Driving force for implementation

Requirement to reduce the PCDD/F concentrations in solid FGT residues.

In some countries the residues from the incinerator may not be re-burned in the installation for legal reasons. In such cases it is considered that the residues are classified as a waste type that is prohibited from treatment within the incineration installation. [64, TWGComments, 2003]

##### Example plants

This technique is used in Belgium and Germany.

##### Reference literature

[55, EIPPCBsitevisits, 2002] [64, TWGComments, 2003]

#### 4.4.5.6 Adsorption of PCDD/F by activated carbon injection or other reagents

##### Description

This technique has already been described in Section 2.5.8.1.

In summary, activated carbon is injected into the gas stream where it mixes with flue-gases. Activated carbon is injected on its own or is combined with (usually) lime or sodium bicarbonate alkaline reagent. The injected alkaline reagent, their reaction products and the carbon adsorbent are then collected in a deduster, usually a bag filter. The adsorption of the PCDD/F occurs in the gas stream and on the reagent layer formed when barrier filters are used (e.g. filter bags).

The adsorbed PCDD/F is discharged with other solid wastes from the bag filter, ESP or other dust collection apparatus used downstream.

It is reported that mineral adsorbents (e.g. mordenite, zeolite, mixtures of clay minerals, phyllosilicate and dolomite) may also be used for PCDD/F adsorption, at temperatures of up to 260 °C without risk of fire in the baghouse. Lignite coke is also reported to be used [64, TWGComments, 2003]. [74, TWGComments, 2004]

The effect of catalytic destruction of PCDD/F at the surface of activated coke has been reported [74, TWGComments, 2004]

##### Achieved environmental benefits

PCDD/F is adsorbed on the activated carbon to result in emissions of below 0.1 ng/Nm<sup>3</sup> TEQ.

Metallic mercury is also adsorbed (see Section 4.4.6.2)

##### Cross-media effects

Cross-media effects of the use of bag filters or other dust abatement systems associated with the use of this technique are described in Section 4.4.2.

Solid residue containing the adsorbed pollutants is produced. It should be noted that the amount removed with the reagent, and accumulated with it, will be lower than that which is removed with the dust by effective dust control. It is reported that 80 % of the PCDD/F is discharged with the dust already removed. [64, TWGComments, 2003]

Polluted reaction material from the FGT system may, in some cases, be used as neutralisation agent in scrubber water effluent treatment and by this reduce amount of fresh material that needs to be added at the waste water treatment stage. There the activated carbon or coke also capture heavy metals e.g. Hg from waste water. It is reported that, no extra residues, except the non-water soluble carbon, are produced by using these reagents in scrubber water. There is a higher risk of ignition/fire and therefore increased safety measures must be in place for storage and handling of activated carbon and coke. [74, TWGComments, 2004]

##### Operational data

Carbon consumption rates of 0.35 - 3 kg/t of waste are reported as typical for MSWI. Higher injection rates may provide additional reductions in PCDD/F. [64, TWGComments, 2003]

Usually the dose rate of activated carbon is between 0.5 and 1 kg/t to fulfil an emission level below 0.1 ng I-TEQ/Nm<sup>3</sup>. French examples:

(1) MSWI 12 t/h - semi-wet FGT: 0.35 kg/t,

(2) MSWI 2.5 t/h - dry FGT: 1.2 kg/t

[64, TWGComments, 2003]

Different types of carbon have different adsorption efficiencies.

### Applicability

The applicability of this technique is assessed in the table below:

Criteria	Evaluation/comment
<b>Waste type</b>	• any
<b>Plant size range</b>	• any
<b>New/existing</b>	• applicable to both – easily retrofitted in most cases
<b>Inter-process compatibility</b>	• may be easily employed where there is an existing bag filter system
<b>Key location factors</b>	• none

**Table 4.71: Assessment of the applicability of carbon injection for PCDD/F removal**

### Economics

Lignite coke is reported to be more economic than activated carbon. [64, TWGComments, 2003] It is also reported that in general the consumption of lignite coke is higher than activated carbon (up to twice the ratio). [74, TWGComments, 2004]

### Driving force for implementation

The technique has been introduced to many plants in order to achieve an emission level  $<0.1$  ng/Nm<sup>3</sup>. [74, TWGComments, 2004]

### Example plants

Widely applied technique in many countries.

### Reference literature

[64, TWGComments, 2003]

## 4.4.5.7 Adsorption of PCDD/F in static beds

### Description

This technique has already been described in Section 2.5.8.6. Wet and dry static coke/coal beds are used. Wet systems include countercurrent washing with water.

### Achieved environmental benefits

Reduction of emissions to air as follows:

- PCDD/F adsorbed to give clean gas emissions below 0.1ng/Nm<sup>3</sup> TEQ
- Hg is adsorbed to give emissions below 50 µg/Nm<sup>3</sup>, typically below 30 µg/Nm<sup>3</sup>
- dust is collected by the filter.

### Cross-media effects

Cross-media effects are identified in the table below:

Criteria	Units	Value	Comments
<b>Energy requirements</b>	kWh/t waste input	30 – 35	Pressure drop across filter
<b>Reagent consumption</b>	kg/t waste input	1	Coke
<b>Residue - type</b>			Used coke
<b>Residue - amount</b>	kg/t waste input	0 – 1	Zero if coke can be burned in the incinerator
<b>Water consumption</b>	l/t waste input		<i>No information</i>
<b>Effluent production</b>	l/t waste input		<i>No information</i>
<b>Plume visibility</b>	+/0/-	+/0	Wet system will add to plume visibility

**Table 4.72: Cross-media effects associated with the use of static filters**  
[12, Achternbosch, 2002]

For this technique, the most significant cross-media effect is the energy required to overcome filter pressure drop.

Fire risk might be increased with dry static coke beds depending on the design of the whole FGT line [74, TWGComments, 2004]

For one rotary kiln HWI line treating 50000 t/yr a new ID-fan was installed. The new ID-fan has 550 kW where the old one had only 355 kW ( $\Delta P$  of the filter of between 25 - 40 mbar) [64, TWGComments, 2003].

When saturated, the used activated carbon is often landfilled as a toxic residue. If permitted, it can be re-burnt in the incinerator to destroy the adsorbed PCDD/F. As the carbon adsorber will adsorb mercury as well as PCDD/F, if re-burn of the spent coke is to be carried out mercury circulation requires careful consideration. The practice of re-burn will result in an accumulation of Hg in the process unless there are additional techniques that provide a mercury outlet, e.g. low pH wet acid scrubbing.

[74, TWGComments, 2004]

### Operational data

Inlet temperature to a dry coke bed is typically 80 – 150 °C, and with wet beds 60 - 70 °C. If followed by an SCR system the reheat required would be greater for a wet system.

With dry systems, particular care is required to ensure that the flue-gas is evenly distributed as this reduces fire risks. The temperature across the bed requires close monitoring and control to reduce fire risk e.g. several CO-measurements over the whole filter body to measure hot spots. [74, TWGComments, 2004] The use of inert gases may be required.

Wet coke filters have a significantly lower fire risk. Neither fire fighting, nor inert blanketing are required. The addition of a partially re-circulated water feed also provides a means for removal of the accumulated dust, that can lead to bed clogging.

It is necessary to assess the bed saturation rate to determine the required reagent replenishment rate. [74, TWGComments, 2004]

The lack of moving parts means that reliability is high.

Criteria	Description of factors affecting criteria	Evaluation (high/medium/low) or data	Comment
<b>Complexity</b>	<ul style="list-style-type: none"> <li>additional process units required</li> <li>critical operational aspects</li> </ul>	M	<ul style="list-style-type: none"> <li>additional process unit required</li> <li>fire risks require careful control (dry systems)</li> </ul>
<b>Flexibility</b>	<ul style="list-style-type: none"> <li>ability of technique to operate under range of input conditions</li> </ul>	H	<ul style="list-style-type: none"> <li>very high adsorption capacity</li> </ul>
<b>Skill requirements</b>	<ul style="list-style-type: none"> <li>significant extra training or manning requirements</li> </ul>	H/M	<ul style="list-style-type: none"> <li>robust, but care required regarding fire risk (dry systems) and if re-burn carried out</li> </ul>

**Table 4.73: Operational data associated with the use of static coke filters**

The following operational data about cross-media effects were reported in respect of the use of a wet static coke bed at a HWI treating around 11000 t/yr waste [64, TWGComments, 2003]:

- use of lignite cokes = 0.5 kg/t waste input
- exhausted lignite is burned into the installation – in this case, due to a low pH wet acid scrubbing system, the re-burn of the spent coke will not result in an accumulation of Hg
- water is used for periodically flushing the lignite bed, this generates acid waste water which is sent to an on-site physico-chemical treatment process
- the wet system, adds to flue-gas humidity and plume visibility.

### Applicability

The applicability of this technique is assessed in the table below:

Criteria	Evaluation/comment
<b>Waste type</b>	<ul style="list-style-type: none"> <li>• any in principle</li> <li>• particularly suited to highly heterogeneous and hazardous wastes where PCDD/F may be high due to difficult combustion conditions</li> </ul>
<b>Plant size range</b>	<ul style="list-style-type: none"> <li>• size does not matter</li> </ul>
<b>New/existing</b>	<ul style="list-style-type: none"> <li>• applied at existing and new processes</li> </ul>
<b>Inter-process compatibility</b>	<ul style="list-style-type: none"> <li>• generally applied as a tail-end polishing stage</li> <li>• most suited down stream of a wet scrubber</li> <li>• can be used up stream of SCR with reheat (more for wet system)</li> </ul>
<b>Key location factors</b>	<ul style="list-style-type: none"> <li>• space required for the additional process unit</li> </ul>

**Table 4.74: Assessment of the applicability of static coke filters**

### Economics

The investment cost of a coke filter for a 100000 t/yr MSWI was estimated at EUR 1.2 million [12, Achternbosch, 2002].

The investments cost for one static bed wet filter (empty) (incineration line of 50000 t/yr) is approximately EUR 1 million (equipment and civil work).

Cost of lignite cokes is:

- a factor three to four times lower than activated coal
- the consumption of lignite cokes is low, so that refilling can be carried out during planned shutdown.
- 

### Driving force for implementation

This technique has been implemented to reduce PCDD/F emissions to below 0.1ng/Nm<sup>3</sup> TEQ

### Example plants

Hazardous waste incinerators in Belgium, Germany and the Netherlands.

Municipal waste incinerators in Germany.

### Reference literature

[1, UBA, 2001, 3, Austria, 2002, 12, Achternbosch, 2002] [64, TWGComments, 2003]

#### 4.4.5.8 Use of carbon impregnated materials for PCDD/F adsorption in wet scrubbers

##### Description

This technique has already been described in Section 2.5.8.5

##### Achieved environmental benefits

PCDD/F are strongly adsorbed on the carbon particles in the material. Therefore the emissions are reduced and the memory effect release of PCDD/F is prevented. [74, TWGComments, 2004] Start-up releases may be reduced.

With inlet concentrations of 6 – 10 ng TEQ/Nm<sup>3</sup>, gas phase removal efficiencies in the range of 60 – 75 % are reported across a wet scrubber. This compares with 0 – 4 % without the impregnated packing material. The adsorption efficiency is reported not to have declined over the test period. [58, Andersson, 2002].

Whilst the achieved outlet concentration (2 – 3 ng TEQ/Nm<sup>3</sup>) do not, on their own, comply with the 0.1 ng/Nm<sup>3</sup> requirement of Directive 2000/76/EC, the technique can be used in combination with subsequent downstream FGT to provide overall compliance. The benefits are therefore:

- prevention of memory effect uptake in wet scrubbers and the associated risk of breakthrough and de-sorption releases
- reduction of PCDD/F loads on subsequent FGT operations (especially during start-up)
- if the used reagent is re-burned in the furnace there will be an overall reduction in dioxin mass balance due to the destruction of the PCDD/F in the furnace (which is facilitated by the separation of the Hg absorption step) rather than its transfer to solid residues.

##### Cross-media effects

The used packing is in some cases landfilled as a toxic residue. In some cases it is re-burned in the incinerator (although local regulations sometimes do not permit re-burn). [74, TWGComments, 2004]

##### Operational data

Criteria	Description of factors affecting criteria	Evaluation (high/medium/low) or data	Comment
Complexity	<ul style="list-style-type: none"> <li>• additional process units required</li> <li>• critical operational aspects</li> </ul>	L/M	Adjustment to existing technique (wet scrubbing)
Flexibility	<ul style="list-style-type: none"> <li>• ability of technique to operate under range of input conditions</li> </ul>	M	
Skill requirements	<ul style="list-style-type: none"> <li>• notable extra training or manning requirements</li> </ul>	L	No significant additional requirements

Table 4.75: Operational data associated with the use of carbon impregnated materials in wet scrubbers

##### Applicability

Applicable to processes that have already selected wet scrubbing systems, particularly during start-up, and where there is evidence of dioxin build up in the wet scrubber and where there is no subsequent FGT stage to control PCDD/F desorbed from the wet scrubber.

Also applicable as a pre-dioxin filter before an additional dioxin filter system – in this way it can be used to reduce the PCDD/F load on the *main* dioxin filter without additional space requirements.



Also used as main dioxin filter in combination with electrostatic precipitator (then requires a more extensive tower packing installation) [74, TWGComments, 2004]

The applicability of this technique is assessed in the table below:

Criteria	Evaluation/comment
<b>Waste type</b>	Any
<b>Plant size range</b>	Any where wet scrubbers are used
<b>New/existing</b>	Applicable to new and existing installations
<b>Inter-process compatibility</b>	Only applicable to wet scrubbers
<b>Key location factors</b>	It is easier to implement in packing tower, using caustic soda

**Table 4.76: Assessment of the applicability of the use of carbon impregnated materials in wet scrubbers.**  
[74, TWGComments, 2004]

### Economics

The approximate investment cost for the initial installation of tower packing in two wet scrubber stages is between EUR 30000 and EUR 150000 in total for incineration plants in the size of 5 to 20 t/hr.

The cost for replacement material is estimated to EUR 0.1 – 0.2/tonne of incinerated waste. No additional energy consumption is anticipated, except the additional pressure drop. [74, TWGComments, 2004]

### Driving force for implementation

This technique has been implemented where there are concerns regarding the PCDD/F concentration in and possible release from wet scrubbers.

The technique has also been installed where a cost-effective dioxin removal of 50 – 70 % reduction degree is required.

### Example plants

The technique has (October 2003) been implemented at 10 municipal and hazardous waste incineration plants in Sweden, Denmark, France and Germany.

### Reference literature

[58, Andersson, 2002] [64, TWGComments, 2003]

#### 4.4.5.9 Use of carbon slurries in wet scrubbers

##### Description

The use of a slurry of activated carbon in wet scrubber can both reduce the level of dioxin emissions to the flue-gas stream and prevent the accumulation of dioxins in the scrubber material ("memory effect").

At a pH near neutral, activated carbon at a concentration varying between a few g/l to 50 g/l, is added into the system, using a decanter to bleed the liquids, while retaining the carbon.

Because the activated carbon has active sites, the dioxin or furan molecules are transferred to the liquids sprayed in the scrubber and the dioxins are subsequently adsorbed on the carbon, where a catalytic reaction takes place.

##### Achieved environmental benefits

Emission of PCDD/F at stack is reduced to 0.01 - 0.1 ng TEQ/Nm<sup>3</sup>.

The activated carbon that is purged from the system is not contaminated.

The activated carbon has also adsorption capacity for mercury. Used under the above conditions, mercury outlet is usually well below  $50\mu\text{g}/\text{Nm}^3$  for municipal waste incineration.

As activated carbon converts  $\text{SO}_2$  to sulphuric acid, this process is also a polishing step for  $\text{SO}_2$  removal.

The waste water evacuated is reported to comply with the PCDD/F ELV in water set by the Waste Incineration Directive 2000 (i.e.  $0.3\text{ ng/l}$ ). [74, TWGComments, 2004]

### **Cross-media effects**

Use of carbon.

Increased risk of fouling by the use of carbon may cause problems to maintain the site in tidy and clean state. [74, TWGComments, 2004]

### **Operational data**

Information not supplied.

### **Applicability**

Only applicable where wet scrubbers are used with caustic soda to provide a pH of near neutral. NaOH must be used to control the pH in the unit where the activated carbon slurry is used.

Not applicable to dry, intermediate or semi-wet scrubbing systems.

### **Economics**

Costs are limited to the reagent costs if used for polishing or to treat memory effect. Only minor modifications to the scrubber system are required to allow use of the technique.

For efficient PCDD/F removal this technique may require a specific packing tower scrubber, to ensure effective contact between flue-gas and washing water. [74, TWGComments, 2004]

### **Driving force for implementation**

The technique has been used in order to achieve emission level below  $0.1\text{ ng TEQ}/\text{Nm}^3$

### **Example plants**

Brussels –Stack:  $0.02 - 0.03\text{ ng TEQ}/\text{Nm}^3$  (dry, @11 %  $\text{O}_2$ )

Mulhouse –Stack  $0.01 - 0.03\text{ ng TEQ}/\text{Nm}^3$  (dry, @11 %  $\text{O}_2$ )...

Toulouse –Stack  $0.04 - 0.1\text{ ng TEQ}/\text{Nm}^3$  (dry, @11 %  $\text{O}_2$ )

Svendborg –Stack  $0.01 - 0.02\text{ ng TEQ}/\text{Nm}^3$  (dry, @11 %  $\text{O}_2$ )

### **Reference literature**

[64, TWGComments, 2003]

## **4.4.6 Reduction of mercury emissions**

### **4.4.6.1 Low pH wet scrubbing and additive addition**

#### **Description**

[63, Langenkamp, 1999] The use of wet scrubbers for acid gas removal causes the pH of the scrubber to reduce. Most wet scrubbers have at least two stages. The first removes mainly HCl, HF and some  $\text{SO}_2$ . A second stage, maintained at a pH of 6 - 8 serves to remove  $\text{SO}_2$ .

If the first stage is kept at a pH of below 1, the removal efficiency of ionic Hg as  $\text{HgCl}_2$ , which is generally the main compound of mercury after waste combustion, is over 95 %. However, the removal rates of metallic Hg are only in the order of 0 – 10 %, mainly as a result of condensation at the scrubber operational temperature of around 60 to 70 °C.

Metallic mercury adsorption can be improved up to a maximum of 20 – 30 % by the:

- addition of sulphur compounds to the scrubber liquor
- addition of activated carbon to the scrubber liquor
- addition of oxidants, e.g. hydrogen peroxide to scrubber liquor. This technique converts metallic mercury to the ionic form as  $\text{HgCl}_2$  to facilitate its precipitation, and has the most significant effect.

The overall Hg removal (both metallic and ionic) efficiency is around 85 %.

It is reported that a removal efficiency higher than 90 % can also be achieved with a technique adding bromine containing wastes or by injection of bromine containing chemicals into the combustion chamber. [74, TWGComments, 2004]

[63, Langenkamp, 1999] At the inlet concentrations usually found with many waste types, and with the additional uncertainty over composition of most wastes, the removal efficiencies of this type of scrubbing is not generally sufficient to reach an emission level below  $50 \mu\text{g}/\text{Nm}^3$ . In one Member State an ELV of  $30 \mu\text{g}/\text{Nm}^3$  has been set. In either case, the addition of further Hg abatement capacity may be required, depending on the inlet concentration, such as:

- carbon injection before a bag filter system
- static coke bed filter.

(see Sections 4.4.6.2 and 4.4.6.7) [74, TWGComments, 2004]

#### **Achieved environmental benefits**

Percentage reduction efficiencies are given in the description above.

The impact of the concentration of Hg in the incinerated waste and the content of Cl are decisive in the determination of the final emission levels achieved.

#### **Cross-media effects**

Cross-media effects of the use of wet scrubbing are given in Section 4.4.3.1.

Consumption of any reagents added..

#### **Operational data**

For MSW with an average concentration of 3 - 4 mg Hg/kg of MSW, emission concentrations to air of 50 – 80  $\mu\text{g}/\text{Nm}^3$  are achieved. [63, Langenkamp, 1999]

The variation of Hg input to MSW can be very large and, therefore, can result in significant variations in emission levels. Values measured at an Austrian MWI gave values between 0.6 and 4 mg/kg. This variation can be much greater in other waste types, e.g. some hazardous wastes.

Achieved levels just with a wet scrubbing system are approx.  $36 \mu\text{g}/\text{Nm}^3$ , with a wet scrubber and an activated coke filter  $<2 \mu\text{g}/\text{Nm}^3$  and with a combination of the flow injection process and a wet scrubber  $4 \mu\text{g}/\text{Nm}^3$ . [74, TWGComments, 2004]

#### **Applicability**

The use of acid wet scrubbers for mercury emission reduction can only meet the emission limits set in Directive EC/2000/76 where:

- the pH is well controlled below 1
- chloride concentrations are high enough for the crude flue-gas Hg content to be almost entirely ionic (and hence removable as the chloride)
- additives are added to the low pH scrubber in some cases.

The applicability of this technique is assessed in the table below:

Criteria	Evaluation/comment
Waste type	
Plant size range	<ul style="list-style-type: none"> <li>any</li> </ul>
New/existing	<ul style="list-style-type: none"> <li>not generally applied on its own at new installations</li> </ul>
Inter-process compatibility	<ul style="list-style-type: none"> <li>see comments for wet scrubbers</li> <li>additional Hg removal may be required to comply with EC/2000/76 (depending on the Hg inlet content)</li> </ul>
Key location factors	<ul style="list-style-type: none"> <li>none</li> </ul>

**Table 4.77: Assessment of the applicability of wet scrubbing for Hg control**

The technique is only applicable to Hg air emission control as an Hg pretreatment step, or where input waste concentrations are low enough (e.g. below 4 mg/kg). Otherwise emissions to air of above 50 µg/Nm<sup>3</sup> may result.

#### Economics

Information not supplied.

#### Driving force for implementation

This technique has been implemented as an adaptation to wet scrubbing for acid gas removal in order to reduce Hg emissions.

#### Example plants

Wet scrubbing is widely used in Europe.

#### Reference literature

[1, UBA, 2001, 2, infomil, 2002, 3, Austria, 2002, 12, Achternbosch, 2002, 55, EIPPCBsitevisits, 2002, 63, Langenkamp, 1999] [64, TWGComments, 2003]

### 4.4.6.2 Activated carbon injection for Hg adsorption

#### Description

This technique involves the injection of activated carbon upstream of a bag filter (see also Section 4.4.5.6, bag filters are described in Section 2.5.3.5), or other de-dusting device. Mercury metal is adsorbed in the stream and where barrier filters such as bag filter are used, also on the reagent that is retained on the bag surface.

#### Achieved environmental benefits

Metallic mercury is adsorbed (usually at about 95 % removal efficiency) to result in emissions to air of below 30 µg/Nm<sup>3</sup>. Ionic mercury is also removed by chemi-adsorption arising from the sulphur content in the flue-gases or from sulphur impregnated in some types of activated carbon. [74, TWGComments, 2004]

In some systems where removal of mercury is carried out in wet acid scrubbers (pH<1) to reduce the inlet concentration, final emission levels below 1µg/Nm<sup>3</sup> are seen.

The carbon also adsorbs dioxins (see Section 4.4.5.6). Bag filters also provide a means of particulate and heavy metal removal. Bag filters are described in Section 2.5.3.5. It is normal for alkaline reagents to be added with the carbon, this then also allows the reduction of acid gases in the same process step as a multifunctional device. [74, TWGComments, 2004]

### Cross-media effects

The cross-media effects are similar to those for other situations where bag filters are used, see Section 4.4.2.2. The energy consumption of bag filters is a significant aspect.

In addition, for this technique the most significant cross-media effect is the production of residues contaminated with removed pollutant (Hg).

In cases where the solid reagent is re-burned (for PCDD/F destruction) in the incinerator it is important that:

- the installation has an outlet for Hg that prevents internal pollutant build up (and eventual breakthrough release)
- the alternative outlet removes the pollutant at a sufficient rate
- where wet scrubbers are used, the Hg can pass into the effluent stream (although it can then be precipitated to the solid residue using treatment techniques).

### Operational data

Operational aspects are similar to other situations where bag filters are used, see Section 4.4.2.2.

Effective bag filter and reagent injection system maintenance are particularly critical to achieving low emission levels.

Different types of activated carbon have different adsorption capacities. Another possibility to improve mercury removal is sulphur impregnation of the adsorbent. [74, TWGComments, 2004]

In experiments carried out at an HWI, various types of activated carbon were used, and the consumption rate per hour required to obtain a particular Hg emission level was as follows:

- coke from coconut shells 8 - 9 kg/h
  - coke from peat 5.5 - 6 kg/h
  - brown coal 8 - 8.5 kg/h
  - peat coal 4 - 4.5 kg/h.
- [64, TWGComments, 2003]

The carbon consumption rate is similar as the mentioned for PCDD/F, as the adsorbent is generally used for both Hg and PCDD/F removal. Carbon consumption rates of 3 kg/t of waste are typical for MSWI. Levels from 0.3 to 20 kg/t of hazardous waste have been reported [41, EURITS, 2002]. The adsorption capacity of the reagent, the Hg inlet concentrations and the required emission level determine the required reagent-dosing rate.

The fire risk is significant with activated carbon. The adsorbent may be mixed with other reagents to reduce the fire risk. 90 % lime and 10 % carbon is used in some cases. The proportion of carbon is generally higher where there are additional process stages that perform acid gas removal (e.g. wet scrubbers).

### Applicability

The applicability of the use of bag filters is assessed in Section 4.4.2.2. The table below details the specific aspects that relate to the use of activated carbon injection:

Criteria	Evaluation/comment
Waste type	• provides effective emission reductions across a range of waste types
Plant size range	• any
New/existing	• applicable to new installations and as a retrofit
Inter-process compatibility	• no specific issues
Key location factors	• none

Table 4.78: Assessment of the applicability of carbon injection for Hg removal

### **Economics**

Additional capital costs of the technique at processes that already have, or intend to use, reagent injection and bag filters are minimal. See also 4.4.5.6.

Additional operational costs are from:

- reagent consumption
- disposal of residues.

The cost of operations (carbon cost) is approx EUR 125000/yr for a facility treating 65000 tonnes of hazardous waste per year.

### **Driving force for implementation**

The technique has been applied to both new and existing systems as a means of reducing Hg emissions to air.

### **Example plants**

Widely used throughout Europe.

### **Reference literature**

[1, UBA, 2001, 2, infomil, 2002, 3, Austria, 2002, 12, Achternbosch, 2002, 55, EIPPCBsitevisits, 2002, 63, Langenkamp, 1999] [41, EURITS, 2002] [64, TWGComments, 2003]

### **4.4.6.3 Use of condensing scrubbers for flue-gas polishing**

#### **Description**

This technique has already been described in Sections 2.4.4.5 and 4.3.16, where they are presented primarily from the energy recovery point of view. In addition to the potential benefits of the use of such systems for energy recovery, the condensing effect of the use of a cold scrubber can condense some pollutants. This may reduce releases of pollutants to air, but only to a significant degree where the scrubber is operated at a particularly low temperature e.g. 40 °C.

#### **Achieved environmental benefits**

The condensation of pollutants from the flue-gas provides an additional reduction of emissions to air. For mercury this technique cannot generally be relied upon, on its own, to achieve emission levels below 50 µg/Nm<sup>3</sup>. It is therefore, only be considered as an additional polishing stage.

The condensation of the water from the flue-gas can, when used with downstream flue-gas heating, greatly reduce plume visibility and reduce scrubber water consumption.

#### **Cross-media effects**

The condensed water will contain pollutants that require treatment in a water treatment facility prior to discharge. Where an upstream wet scrubbing system is applied the effluent from the condensing scrubber can be treated in the same facility.

The technique is generally only applied where there is a readily available cooling source. For example, a particularly cold (40 °C) district heating water return, which is generally only encountered in colder climates. The application of this technique in other circumstances (it is not reported in other circumstances) would lead to high energy costs for the cooling required.

The low temperature of the stack discharge will reduce the thermal buoyancy of the plume and hence reduce dispersion. This can be overcome by using a taller and/or reduced diameter stack.

**Operational data**

The temperature of the scrubber effluent is critical for some pollutants, e.g. to ensure mercury is condensed and does not pass through the scrubber to be released to air. The supply of a sufficiently cold cooling medium is, therefore, critical. To be effective for metallic Hg removal, scrubber outlet temperatures of below 40 °C may be required (note: even lower temperatures still are reported in some cases - see below).

Cooling the gas using a gas cooler (i.e. no liquid injection) until the temperature is as low as 5 °C has been reported not to give sufficient results for Hg abatement (ref. Bayer AG Dormagen, DE - HWI).

The low temperature of the flue-gases can result in condensation and, hence, corrosion in the chimney unless lined.

**Applicability**

The technique is applied primarily as an energy recovery technique and where additional pollutant removal steps have already been incorporated in the installation (e.g. carbon absorption, low pH wet scrubbing).

The technique is not generally applied on its own as a means for pollution control but can be effective as a polishing stage in combination with other systems.

Waste types: Because the technique is applied after the flue-gas cleaning stages, in principle the technique could be applied to any waste type.

Plant size: The technique has been applied at municipal plants of 175000 and 400000 tonnes per year throughput.

New/existing: The technique is applied at/near the end of the FGT system and could therefore be applied to new and existing processes alike.

The technique is only likely to be applicable where energy is not required to provide the additional scrubber cooling necessary to achieve the low temperatures. It is, therefore, only likely to be applicable in colder northern climates, where colder district heating returns provide the energetic driving force.

**Economics**

The total additional investment for a condensation scrubber is roughly estimated to EUR 3 million. [5, RVF, 2002]

**Driving force for implementation**

Additional heat sales are the main driver for using the technique. The additional pollutant removal is a secondary benefit.

**Example plants**

Several examples of MWI in Sweden, and a SSI in the Netherlands.

**Reference literature**

[5, RVF, 2002], [64, TWGComments, 2003]

#### 4.4.6.4 Separation of mercury using a resin filter

##### **Description**

After dust separation and the first acidic wet rinse, the raw acids in the ionically bound heavy metal are carried off through an Hg ion exchanger. Mercury is separated off in a resin filter. Then the acid is neutralised using lime milk.

If, after washing, there is still residual mercury in the exhaust air, it is retained by a downstream oven coke filter.

##### **Achieved environmental benefits**

High reliability abatement of Hg.

##### **Cross-media effects**

The resin filter will require regeneration which results in the transfer of the abated Hg.

##### **Operational data**

Information not supplied.

##### **Applicability**

The technique is reported to not be widely applied in the sector.

##### **Economics**

The technique is indicated by the TWG to be expensive in relation to alternatives.

##### **Driving force for implementation**

Information not supplied.

##### **Example plants**

RMVA Köln, Germany

##### **Reference literature**

[64, TWGComments, 2003]

#### 4.4.6.5 Chlorite injection for elemental Hg control

##### **Description**

While oxidised mercury is readily soluble in water and can be removed using a wet scrubber, elemental mercury is not. Therefore, it is difficult to achieve a significant abatement of the elemental mercury in a wet scrubber, unless activated carbon is also used.

The injection of a strong oxidising agent will convert the elemental mercury into oxidised mercury and make its scrubbing possible in the wet scrubber. To avoid that, this agent is used up by reaction with other compounds (e.g. sulphur dioxide) and it is introduced just before the spray nozzles of the first acidic scrubber. The pH of the scrubber is kept between 0.5 and 2.

When the sprayed liquid comes into contact with the acidic fumes containing hydrogen chloride, chlorite is transformed into chlorine dioxide, which is the actual active species. It is to be noted that, unlike other oxidants such as hypochlorite (bleach), the chlorite or chlorine dioxide lacks the ability to introduce a chlorine atom into an aromatic ring, and therefore cannot alter the dioxin balance.

##### **Achieved environmental benefits**

Reduced mercury emissions.

Side benefit: NO<sub>x</sub> reduction.



**Cross-media effects**

The use of oxidants favours removal of NO in the scrubber (by changing it into NO<sub>2</sub> which is more soluble). This can lead to problem of high nitrogen content in the waste water. There is no ELV for NH<sub>3</sub> in the WI Directive, but local regulation often sets a limit, as it is a great concern for the aquatic environment. [74, TWGComments, 2004]

**Operational data**

Information not supplied.

**Applicability**

Incineration of waste; mercury abatement of flue-gas containing at least 400 mg/Nm<sup>3</sup> of hydrogen chloride.

Compatible only with wet scrubbing systems.

**Economics**

The cost of the reagent is the limiting factor.

**Driving force for implementation**

Information not supplied.

**Example plants**

Botrop & Ludwigshafen waste incineration plants in Germany

**Reference literature**

[64, TWGComments, 2003]

**4.4.6.6 Addition of hydrogen peroxide to wet scrubbers****Description**

The purpose of the system is to separate Hg, HCl and SO<sub>2</sub> from flue-gas. In the process all elemental mercury is oxidised to water soluble Hg.

The first step is a quench situated downstream from a baghouse filter (with carbon injection – which will absorb much of the Hg). In the quench the flue-gas is cooled so that it is saturated. After the quench the flue-gas comes into contact with the scrubber fluid which contains hydrogen peroxide and an additive. The scrubber fluid reacts with the flue-gas and an acidic waste water is transferred to neutralisation and precipitation of mercury.

**Achieved environmental benefits**

Additional reduction of concentration of all types of mercury in flue-gas (together with activated carbon usually at about 99.5 % removal efficiency) as well as reduction of HCl and SO<sub>2</sub>.

**Cross-media effects**

Consumption of reagents added H<sub>2</sub>O<sub>2</sub> (35 %wt) 4 - 5 kg/t hazardous waste. The consumption can increase as H<sub>2</sub>O<sub>2</sub> reacts not only with Hg but also with all other oxidisable compounds like Fe or heavy metals. [74, TWGComments, 2004]

**Operational data**

Similar to those described for other wet scrubbers (see Table 4.34).

**Applicability**

This method is applicable to all types of waste incinerators using wet scrubbing. The best effect is reached if the scrubber is situated down stream from a baghouse filter with carbon injection.

### **Economics**

The cost of an installation is approx EUR 4 million for a capacity of 200000 tonnes of waste.

This is the cost of the wet scrubber including the specific technique mentioned here, but not the additional cost of applying this technique.

H<sub>2</sub>O<sub>2</sub> is reported to be costly and its consumption may prove difficult to control. [74, TWGComments, 2004]

### **Driving force for implementation**

Technique can be used at both new and existing facilities that needs to cope with new and lower emission limits for Hg, HCl and SO<sub>2</sub>.

### **Example plants**

Sydkraft Sakab in Sweden.

### **Reference literature**

[64, TWGComments, 2003]

#### **4.4.6.7 Use of static activated carbon or coke filters**

The use of these techniques, and their benefits for Hg reduction, cross-media effects and other issues has already been described in Section 4.4.5.7.

Hg is adsorbed to give emissions to air typically below 30 µg/Nm<sup>3</sup>.

#### **4.4.7 Other techniques and substances**

##### **4.4.7.1 Use of specific reagents for iodine and bromine reduction**

###### **Description**

This technique has already been briefly described in Section 2.5.4.1.

Special reagents e.g. sodium thiosulphate or sodium bisulphite, can either be added as required to an existing wet scrubbing system for the treatment of particular batches of waste (when knowledge of the waste content is critical) or added routinely to an additional stage of the wet scrubbing (when consumption of reagent may be higher).

In the halogen-scrubber, any free halogens are reduced to halogen-hydrides by reaction with an alkaline Na<sub>2</sub>S<sub>2</sub>O<sub>3</sub> solution. Together with the remaining SO<sub>2</sub> the halogen-hydrides are then removed from the flue-gas by dissolution.

The halogens in question are bromine and iodine, mainly deriving from flame-retardants and medical waste. As fluorine and chlorine are stronger oxidising agents, both are totally reduced to hydrides.

It is also possible to reduce I and Br emissions to air by injecting sulphur containing wastes or SO<sub>2</sub> in the furnace. [64, TWGComments, 2003]

###### **Achieved environmental benefits**

A yellow/brown or purple coloured flue-gas can be seen in some cases when appreciable concentrations of bromine or iodine (respectively) pass through the FGT system. The use of targeted or regular Na<sub>2</sub>S<sub>2</sub>O<sub>3</sub> addition prevents this effect.

### Cross-media effects

The consumption of  $\text{Na}_2\text{S}_2\text{O}_3$  depends on the sulphur content of the waste, with its addition being controlled according to the  $\text{SO}_2$  concentration in the raw gas. If the waste contains enough sulphur, no additional reduction of halogens is required.

The removed pollutants are transferred to the effluent, subsequent treatment may, therefore, be required.

Where  $\text{SO}_2$  or higher sulphur wastes are added this will require a change in the operational set up of subsequent FGT stages to allow for the altered standard waste chemistry. Changes in the S/Cl balance can also effect PCDD/F reformation rates.

### Operational data

It has not been possible to control the process by on-line redox measurement, due to a mixture of several interfering redox processes in the scrubber water. The addition is, therefore, controlled by the  $\text{SO}_2$  concentration in the raw gas. If the waste contains enough sulphur, no additional reduction of halogens is required – this reflects the alternative option of metered burning of higher S waste or  $\text{SO}_2$  injection mentioned above.

### Applicability

Mainly applicable to HWIs or other installations where concentrations of iodine and bromine in the waste incinerated are highly variable and/or difficult to predict/control. In general it is only HW installations that may have iodine or bromine concentrations in the waste that merit the use of such special measures for their control.

The applicability of this technique is assessed in the table below:

Criteria	Evaluation/comment
Waste type	<ul style="list-style-type: none"> <li>mainly applied to HWIs where I and Br loads in the waste can be high e.g. wastes from laboratories or chemical/pharmaceutical wastes</li> </ul>
Plant size range	<ul style="list-style-type: none"> <li>any</li> </ul>
New/existing	<ul style="list-style-type: none"> <li>targeted reagent addition may be used at any existing plant with a wet scrubber system</li> <li>addition of a permanent dosing system is more complex/expensive to add to existing processes, but can be incorporated in new plant designs</li> </ul>
Inter-process compatibility	<ul style="list-style-type: none"> <li>applied with wet scrubber systems</li> </ul>
Key location factors	<ul style="list-style-type: none"> <li>sensitivity to visible (coloured) plume releases</li> </ul>

**Table 4.79: Assessment of the applicability of  $\text{Na}_2\text{S}_2\text{O}_3$  for halogen removal**

Difficulties in control and steering is reported. [74, TWGComments, 2004]

### Economics

The construction costs for a third scrubber step at an existing HWI (in Denmark) are approximately EUR 600000 (2000 price).

The yearly consumption of  $\text{Na}_2\text{S}_2\text{O}_3$  for each of the three incineration lines, as an average, is approximately 50 tonnes. At a price of EUR 0.5/tonne the total costs for running this third step (excluding power) for the scrubber pumps etc. are EUR 25000/yr per line.

Costs for targeted addition of reagent are likely to be lower, but additional resources may be required for control and management of incoming wastes.

Costs for addition of reagent to an existing wet scrubber system are limited mainly to the reagent costs and is, therefore, significantly less expensive than adding a separate scrubbing stage.

Costs of SO<sub>2</sub> injection are the gas costs. The addition of higher sulphur waste will depend on the availability of such.

### **Driving force for implementation**

This technique has been implemented where:

- control of iodine and bromine emissions is required
- concentrations of iodine and bromine in the waste incinerated are highly variable and/or difficult to predict/control.

### **Example plants**

The additional stage scrubber has been applied at a HWI in DK. Targeted dosing is applied at many other European HWIs.

### **Reference literature**

[25, Kommunikemi, 2002] [64, TWGComments, 2003]

## **4.5 Waste water treatment and control**

### **4.5.1 General**

The general principles to be applied in respect of the selection and operation of waste water treatment systems have already been outlined in the BREF on common waste water and flue-gas management in the chemical sector. This section of this BREF, therefore, only deals with some specific issues that have been identified as important for, or specific to, the WI sector.

### **4.5.2 Application of optimal incineration technology**

An optimal incineration process is an important condition for an effective control of emissions to water. Incomplete incineration has a negative effect on flue-gas and fly ash composition, by the increased presence of organic compounds with a polluting and/or toxic character. These in turn can impact on the content of scrubber effluent.

The techniques to be considered in respect of reducing the polluting content of the flue-gases (and hence reducing the potential for risk of transfer to scrubber effluents) have already been outlined in Sections 4.1 and 4.2.

### **4.5.3 Application of waste water free gas cleaning technology**

#### **Description**

Waste water free technologies for gas cleaning can be achieved by:

- use of dry and semi-wet processes - these do not give rise to waste water
- wet processes that use evaporation – wet FGT gives rise to a waste water, however under certain conditions this waste water can be recirculated into the process and evaporated.

Some features of these processes are given in Chapter 4.4.3.

#### **Achieved environmental benefits**

- no discharge of waste water
- reduction in consumptions associated with waste water treatment
- recovery of salts in evaporation.

**Cross-media effects**

- salts and other substances that would have been discharged to water accumulate in scrubber residues or WWTP residues
- energy consumption of evaporation unit, if applicable – this may not be as significant if supplied from otherwise wasted heat.

**Operational data**

See information included in the description above.

Dry and semi-dry FGT systems do not generate waste water. Other waste water from other on-site processes or rainwater may be recycled in semi-wet or wet systems. Wet processes generate waste water that can be discharged after treatment or evaporated either on line or in a specific evaporation unit. The amount of waste water from a wet process is typically 0.2 m<sup>3</sup>/t of waste.

Evaporation of effluent may cause risk of fouling in the evaporative cooling tower. [74, TWGComments, 2004]

**Applicability**

Technologies that give rise to waste water free incineration (as described here) can in principle be applied to all waste incinerators.

The relatively larger amounts of solid wastes produced with dry and semi-dry systems may make these systems less favourable where availability of waste treatment/disposal outlets is reduced, or the costs of such are higher.

Where a discharge of effluent is acceptable, there is reduced incentive to adopt systems that eliminate this discharge. Possible examples include marine environments that can absorb post treatment salty waste waters without environmental impacts.

**Economics**

Energy costs for separate evaporation plant may be high.

Where solid waste disposal costs are high there may be benefits in adopting wet flue-gas treatment with (or without where a discharge can be made) evaporation owing to the reduced solid waste arising.

An outlet for recovered salt arising in separate evaporation systems will avoid the need to pay disposal charges for this fraction.

**Driving force for implementation**

The lack of availability of a water discharge outlet is a key driver.

**Example plants**

Evaporation is carried out at a number of installations in Germany and gives rise to wet FGT installations that do not discharge an effluent.

Zero-effluent production FGT (i.e. non-wet FGT) systems are widely used throughout Europe.

In France: Azalys (wet process + evapocondensation of the waste water), Arcante, Ouarville (semi-wet + wet processes). [74, TWGComments, 2004]

**Reference literature**

[2, infomil, 2002] [64, TWGComments, 2003] [74, TWGComments, 2004]

#### 4.5.4 Re-circulation of polluted waste water in wet gas cleaning systems

##### **Description**

Polluted waste water from wet scrubbers is re-circulated as much as possible before any treatment, so that it may be re-used as a feed for the scrubbers or as dilution water for organic flocculants for sewage sludge dewatering.

##### **Achieved environmental benefits**

Reduction in water consumption by wet scrubbers.

##### **Cross-media effects**

Consumptions associated with the treatment of waste water.

##### **Operational data**

Organic flocculants can be diluted from 3 % concentration to 0.1 – 0.2 % with the salt containing waste water without any problems. Re-using the waste water in scrubbers depends on the concentration of salt.

##### **Applicability**

Only of use in wet scrubbing systems or for sewage sludge dewatering.

##### **Economics**

No fresh water for dilution of organic flocculants is necessary, reduced effluent to the sewer plant, reduced demand of fresh water. [74, TWGComments, 2004]

##### **Driving force for implementation**

Reduction of waste water effluent/legal demand.

##### **Example plants**

MHKW Bamberg in Germany and some HWI.

##### **Reference literature**

[64, TWGComments, 2003] [74, TWGComments, 2004]

#### 4.5.5 Additional cooling of feed water of wet gas cleaning systems

##### **Description**

The technique involves the cooling of scrubber inlet water, using:

- a cooling system (air or cooling tower)
- an available cold water supply e.g. sea or river water, or a cold (typically below 40 - 50 °C) district heating supply

##### **Achieved environmental benefits**

The main benefit in relation to process water control is the possibility of reducing wet scrubber water consumption.

For other aspects see the general section on cooling system selection in 4.3.10

### 4.5.6 Use of boiler drain water as a water supply for scrubbers

**Description**

Boiler water requires regular draining in order to reduce the dissolved solids levels and to maintain the system. This waste water stream can be fed to the scrubbers (semi-dry and wet) instead of separate treatment/discharge.

**Achieved environmental benefits**

Reduction in water consumption by replacement of scrubber feed-water.

**Cross-media effects**

It is important to check if the quality of the effluent is suitable the process. In particular, to prevent risk of fouling due to salt precipitation (e.g. calcium phosphate). [74, TWGComments, 2004]

**Operational data**

Information not supplied.

**Applicability**

Only applicable to gas cleaning systems that require a water feed (i.e. not dry systems unless conditioning feed-water is added)

**Economics**

Information not supplied.

**Driving force for implementation**

Information not supplied.

**Example plants**

MHKW Bamberg in Germany and many other MWIs in Europe

**Reference literature**

[2, Infomil, 2002]

### 4.5.7 Treatment of laboratory waste water in the scrubber

**Description**

Some laboratory waste water streams contain low levels of contamination and can be used as make up water for scrubber feeds.

By segregating unsuitable materials, those that might lead to increased emissions or process problems in the laboratory, the relatively low flow of these wastes can be incorporated into the plant treatment facility.

**Achieved environmental benefits**

- reduction in water consumption at scrubbers (only a small reduction)
- reduction of potential emissions by treating in process the laboratory waste water.

**Cross-media effects**

Some substances may not be effectively treated in the scrubber if added at the wrong part of the system, or they may adversely impact upon the scrubber performance.

**Operational data**

Ensuring inappropriate substances are not discharged to the scrubbers with the laboratory waste water, relies on the assessment, and efficient segregation, of waste in the laboratory.

### **Applicability**

Only applicable where wet scrubbers are used.

Applicable to sites that have on-site laboratory facilities, particularly HWIs.

### **Economics**

The waste is dealt with in the process and therefore saves external disposal costs.

### **Driving force for implementation**

### **Example plants**

### **Reference literature**

[2, infomil, 2002] [64, TWGComments, 2003]

## **4.5.8 Re-circulation of effluents to the process in place of their discharge**

### **Description**

Because the incineration process itself provides a means of concentration and removal of pollutants from waste streams, it is possible for low to medium volume waste water effluents to be fed into the incineration process at appropriate points. This can be done in such a way that it does not prejudice the operation of the incineration plant, nor its environmental performance.

Examples of such practices are given in Sections 4.5.4, 4.5.5, 4.5.6, 4.5.7 above. Other possibilities include:

- the use of leachate from open-air bottom ash or other storage areas for the supply of water to the de-slaggers
- use of collected rainwater for scrubber feed
- recirculation of condensates
- cooling water from electricity production
- permeated water from boiler water preparation.  
[74, TWGComments, 2004]

### **Achieved environmental benefits**

If well designed and operated, such a system can allow the waste incinerator to:

- concentrate inorganic pollutants into solid wastes (e.g. with FGT residues or WWT residues)
- reduce water consumption
- eliminate, or limit, the need for effluent discharges.

### **Cross-media effects**

Where effluent stream treatment is required to improve its quality in order to allow re-circulation, this will result in additional energy and materials consumptions (and costs) that could be sufficiently large to negate the benefits of the eventual re-circulation. Such an assessment will depend greatly upon local detailed circumstances.

It is essential that the re-circulation of materials within the installation is accompanied by outlets for those materials that may accumulate. Accumulation of some substances (notably Hg) can lead to build up and eventual breakthrough and release. To avoid such possibilities a correct assessment and provision of *sinks* for such substances is required.

In particular these techniques tend to cause a concentration of pollutants into the solid waste stream.



**Operational data**

It is possible to identify opportunities for re-circulating partially contaminated waste streams for other uses within the installation by assessing overall flows and exchanges of mass. Such assessments are sometimes called *Pinch Assessments* or *Materials Exchange Networks*. Such tools, when applied to effluent systems, provide a means for assessing the possibility of effluent re-circulation, taking into account the quality requirements of the inputs to the process units themselves and the overall objective of the system to reduce emissions.

**Applicability**

The re-circulation of effluents may be applied at all WI installations, although will have particular benefits where:

- the re-circulation can be made without interim pretreatment of the effluent
- there is a particular need to reduce installation water consumption
- availability of discharge outlets is restricted.

**Economics**

Costs will increase if interim effluent treatment is required.

Savings may be made by reducing water consumption and discharge costs.

**Driving force for implementation**

Particular drivers include:

- lack of availability of effluent discharge outlets – e.g. restricted by legislation or local circumstances
- dry climates where water supply may be limited.

**Example plants**

MSWI with zero discharge: Azalys, Ouarville [74, TWGComments, 2004]

**Reference literature**

[72, El-Halwagi, 1997], [64, TWGComments, 2003] [74, TWGComments, 2004]

**4.5.9 Separate discharge of rainwater from roofs and other clean surfaces****Description**

This technique involves the separation of the drainage of clean rainwater so that it does not mix with potential and actual contaminated streams.

**Achieved environmental benefits**

- reduction in the volume of waste water requiring treatment
- the remaining polluted fraction is of higher concentration and can, therefore, be more effectively treated.

**Cross-media effects****Operational data**

Separate discharge is recommended to avoid a dilution effect of the treated waste water. The more concentrated effluent that results from separation, can be more effectively treated.

Prevention of sudden large volume additions to ETPs or storage areas.

### **Applicability**

Applicable to all WI.

If the incinerator is located in a community with only one sewer for both polluted waste water and rainwater the separate collection of unpolluted streams is of limited sense., unless it can be suitably treated for direct discharge to the environment. [74, TWGComments, 2004]

### **Economics**

Retrofit costs can be significant at existing sites, but can be installed efficiently at new sites.

Savings may be made from the reduction in water holding capacity needed on the site.

### **Driving force for implementation**

In some countries the mixing of uncontaminated rainwater with other effluents is not permitted.

### **Example plants**

Applied throughout Europe.

### **Reference literature**

[64, TWGComments, 2003] [74, TWGComments, 2004]

## **4.5.10 Provision of storage/buffering capacity for waste water**

### **Description**

The larger the volume of storage that is provided the greater the homogeneity of the waste water composition. This, in turn, allows improved optimisation and process control at the treatment stage.

### **Achieved environmental benefits**

- lower emission to water
- improved stability and confidence in treatment processes
- optimisation of treatment can lead to reduced consumptions for effluent treatment.

### **Cross-media effects**

Information not supplied.

### **Operational data**

Information not supplied.

### **Applicability**

This system is of greater importance where wastes are highly heterogeneous, or of uncertain composition, as this leads to greater variation in the effluent content.

### **Economics**

It is necessary to provide for higher volume for buffering and throughput capacity of waste water treatment. Often costs for effluent treatment are different for waste water and rainwater as described under 4.5.9. [74, TWGComments, 2004]

### **Driving force for implementation**

Information not supplied.

### **Example plants**

Amagerforbrænding, DK

### **Reference literature**

[64, TWGComments, 2003] [74, TWGComments, 2004]

### **4.5.11 Application of physico-chemical treatment to wet scrubber effluents and other contaminated waste water from the plant**

#### **Description**

A description of the technique is provided in Section 2.6.4.1 (physico-chemical treatment in general) and 2.6.4.2 (use of sulphides).

In general, the provision of a waste water treatment systems for wet scrubber effluents, as well as for collected waste water in the plant (see 4.5.10), is considered essential. [64, TWGComments, 2003]. [74, TWGComments, 2004]

#### **Achieved environmental benefits**

Emission levels achieved using these techniques are provided in Sections 3.3.4 and 3.3.5.

With the application of sulphides to increase heavy metal precipitation from wet scrubbing effluents a reduction of Hg levels in effluents treated of 99.9 % can be achieved. Emission levels to water of Hg below 0.003 mg/l can be achieved. Other substances are also reduced (see Table 3.27)

#### **Cross-media effects**

Consumption of energy and raw materials in the ETP.

#### **Operational data**

Operation of ETP is generally considered to be a critical process step, requiring close supervision and operation to ensure the final effluent quality remains good.

Problems with incrustation and clogging of pipes by sedimentation may occur. [74, TWGComments, 2004]

#### **Applicability**

Applicable to all incineration installations with wet scrubbing. May also be applicable to other waste water streams that require such treatment prior to their discharge. [74, TWGComments, 2004]

#### **Economics**

Additives and reagents can be costly. [74, TWGComments, 2004]

#### **Driving force for implementation**

A legal requirement in many countries. Minimum standards for the quality of discharged effluents are included in the WID (EC/2000/76).

#### **Example plants**

Widely applied throughout Europe to installations with wet scrubbing.

#### **Reference literature**

[2, infomil, 2002], [1, UBA, 2001], [64, TWGComments, 2003] [74, TWGComments, 2004]

### 4.5.12 Ammonia removal from effluents

#### Description

Described in Section 2.6.4.4.

Ammonia slip can result from the use of ammoniacal reagents for NO<sub>x</sub> reduction. Slip is higher when reagent dosing is high or poorly optimised, and is generally higher with SNCR than SCR systems. The ammonia is highly soluble in water and will accumulate in the effluent from downstream wet scrubbers. Using special apparatus, such as stripping, reverse osmosis, or others, it is possible to remove ammonia from wet scrubber effluents. It is possible for the ammonia so collected, to be returned for use as a NO<sub>x</sub> reduction reagent.

[74, TWGComments, 2004]

#### Achieved environmental benefits

The main achieved environmental benefits are:

- reduction of ammonia in the discharged scrubber effluent
- reduction in ammonia consumption where recirculated to the NO<sub>x</sub> reduction reagent.

#### Cross-media effects

Ammonia removal techniques require significant additional energy consumption for their operation and there is the risk of fouling. [74, TWGComments, 2004]

#### Operational data

Handling of ammonia solutions requires care to reduce risk of exposure.

#### Applicability

The technique can be applied to all WI installations with wet scrubbers downstream of ammonia/urea reagent injection for NO<sub>x</sub> reduction.

The technique is of particular benefit where ammonia slip levels downstream of the boiler are higher. This tends to occur where:

- it is difficult to optimise the SNCR reagent injection (e.g. injection/mixing/temperature are poorly optimised)
- reagent injection levels are relatively high (e.g. where high NO<sub>x</sub> abatement is required).

[74, TWGComments, 2004]

Higher SNCR reagent injection rates (larger over-stoichiometric rates) are particularly common when the required NO<sub>x</sub> reduction rate is high. This is generally the case when NO<sub>x</sub> ELVs are set at lower levels and SCR is not used. For most waste incinerators using SNCR, guaranteeing emission levels (daily average) below 150 mg/Nm<sup>3</sup> (below 120 mg/Nm<sup>3</sup> for some prepared wastes in fluidised beds) requires these higher reagent injection – the associated increased risk of ammonia slip, therefore, enhances the applicability of using wet scrubbers with ammonia stripping.

#### Economics

Operational and capital costs for the ammonia stripper may be partially offset by reduction in reagent costs when the recovered ammonia is re-circulated to the SNCR reagent injection.

#### Driving force for implementation

The main driving force for the technique is the restriction of ammonia levels in the effluent discharged from the site.

#### Example plants

Umea, Northern Sweden.

#### Reference literature

[55, EIPPCBsitevisits, 2002], [64, TWGComments, 2003] [74, TWGComments, 2004]

### 4.5.13 Separate treatment of effluents arising from different wet scrubbing stages

#### Description

Described in more detail in Section 2.6.4.5.

The technique involves the separation and separate treatment of the acid and alkaline wet scrubber streams in order to allow improved optimisation of the effluent and increased options for the recovery of components of the effluent streams.

#### Achieved environmental benefits

- emissions to water can be reduced further than with combined treatment
- optimisation of separate streams reduces reagent consumption and allows targeted treatment
- gypsum can be recovered from sulphur scrubbers (see Section 4.5.17) this reduces sulphur discharges with the waste water and sulphur content of solid residues from the ETP
- HCl may be regenerated from first stage acid scrubbers (see Section 4.5.16).

#### Cross-media effects

Additional energy and materials consumption

An outlet for recovery of the materials is required. This may be complicated due to impurities. [74, TWGComments, 2004]

#### Operational data

Additional complexity from the operation of two ETP lines. More complexity means, higher investment and operational cost and more space required.

There may be problems recovering HCl as HF may give rise to impurities.

#### Applicability

Only applicable to WI installations with wet scrubbers - can be applied, in principle, to all such installations.

Cost of replacing existing combined treatment systems is likely to be very high – the technique may therefore in general only be suited to new installations where there are special driving forces for effluent purity etc.

Most applicable where there is a need for final effluent of the highest quality and/or where there are outlets for the beneficial use of the recovered HCl/gypsum.

#### Economics

Operational and capital costs for the second ETP may be partially offset by reduced disposal costs when gypsum and salts like NaCl or CaCl are recovered. [74, TWGComments, 2004]

#### Driving force for implementation

The existence of markets for the recovered materials may drive the adoption of this system. The main reason is generally the application of particularly low effluent discharge emission limits, possibly to protect a sensitive water body.

#### Example plants

Reported to be employed in the Netherlands, Germany and Austria.  
Seen in use at the Umea Plant in N Sweden for discharge to a fresh water river.  
Vestforbrænding and Odense, DK

#### Reference literature

[64, TWGComments, 2003]

#### 4.5.14 Evaporation of wet scrubber effluent in the incineration process

##### Description

Described in Section 2.6.4.7.1

Pollutants (acid gas, heavy metals, etc.) are removed from the cleaning process during exhaust air cleaning and transferred to wet scrubber effluent. This effluent is neutralised (e.g. with lime milk). Complex builders are also injected to treat heavy metal compounds. Then the final effluent is sprayed into an evaporative cooling tower and vaporises using the energy of the flue-gas at the boiler outlet.

Other aspects of this technique have already been described in Section 4.5.3 on the application of waste water free FGT.

[74, TWGComments, 2004]

#### 4.5.15 Separate evaporation of wet scrubber effluent

##### Description

Described in Section 2.6.4.7.2.

Other aspects of this technique have already been described in Section 4.5.3 on the application of waste water free FGT.

An outlet for recovered solid residues (e.g. Salt) arising from effluent evaporation is required. Impurities have proven to complicate this in some cases. [74, TWGComments, 2004]

#### 4.5.16 Recovery of hydrochloric acid from wet scrubber effluents

##### Description

See Section 2.6.4.8 for a description of this process.

In the recovery of HCl, a product with a concentration of about 30 % of hydrochloric acid is produced from untreated acid of about 10 %.

##### Achieved environmental benefits

The recovered hydrochloric acid may be used e.g. for pH control.

If the HCl was not recovered, it would require neutralisation, giving a salt laden effluent requiring either discharge or evaporation. Recovering HCl therefore results in a reduction in the salt content of the effluent produced.

If evaporation (not discharge) of the salt laden effluent is the option chosen, recovering HCl effectively reduces the amount of solid salt residues arising from the installation by approximately 50 % [73, Rijpkema, 2000].

##### Cross-media effects

Requirement of energy and use of chemicals in the recovery process.

**Operational data**

Data from two plants in Germany are shown in the table below:

Year of data	Kg of HCl recovered per tonne of waste	
	Plant at Borsigstrasse	Plant at Rugenberger Damm
2000	10	10
2001	-	12.5
2002	10.6	13

**Table 4.80: Quantity of HCl (30 %) recovered per tonne of waste**  
[64, TWGComments, 2003] [74, TWGComments, 2004]

It is vital that systems and materials are required to avoid/limit corrosion in the recovery system.

The use of one plant was reported to have been discontinued following difficulties with HF contamination of the recovered HCl.

**Applicability**

Most suited to those which treat high amounts of chlorinated waste i.e. where there are large amounts of HCl to be recovered. [74, TWGComments, 2004]

Only applicable where wet scrubbing is used.

**Economics**

Significant investment is necessary, therefore these procedures are only applicable where sufficient flue-gas loading with chlorine is available. Maintenance and operating costs can also be high owing largely to the highly corrosive nature of the material being recovered. [74, TWGComments, 2004]

The benefits of the products may not be that significant (there are market fluctuations) but waste disposal costs are reduced. Eco-efficiency analysis have shown that this technique is economic in some circumstances compared to other procedures.

**Driving force for implementation**

Raw material recovery. Savings of neutralisation cost.

**Example plants**

Rotary kilns (HWI) in Germany including Schkopau and Stade. Also used at a MWI in Hamburg.

In Germany there are six plants with HCl procedure.

**Reference literature**

[64, TWGComments, 2003], US patent Number 5174865 from December 29, 1992

**4.5.17 Recovery of gypsum from wet scrubber effluent****Description**

This technique involves the separate treatment of the effluent from the high pH (6 – 8), sulphur dioxide removal stage in wet scrubbers; this can allow the production of saleable gypsum.

In a multi stage wet scrubber, at the earlier stages the dust and the HCl are removed from the flue-gas. Then the flue-gas is passed to the SO<sub>2</sub> cleaner, where the SO<sub>2</sub> is absorbed by oxidation to sulphate by the addition of lime.

The gypsum suspension formed is removed and thickened in a hydro-cyclone and is then passed to a container. The gypsum suspension is then dehydrated in a centrifuge. The gypsum is then cleaned with condensate to remove the remaining soluble contaminants. Further centrifuging is carried out until a remaining humidity of less than 10 % weight and, if required, the whiteness for marketing of this gypsum is reported to be possible. [74, TWGComments, 2004]

### Achieved environmental benefits

- recovery of gypsum
- reduction of sulphate content of discharged effluent by its removal from the waste water
- where re-use outlets can be found this reduces gypsum disposal, either on its own or with other residues
- reduction of solid residues
- when mixing together with hydroxide with sludge from the first waste water cleaning stage, which is very difficult to dewater, the dewatering effect of this mixture is greatly improved up to 70 % d.s.  
[74, TWGComments, 2004]

### Cross-media effects

- consumption of energy and materials in treatment/recovery plant.

### Operational data

Data from two plants in Germany are shown in the table below:

Year of data	Kg of Gypsum recovered per tonne of waste	
	Plant at Borsigstrasse	Plant at Rugenberger Damm
2000	3.5	1.7
2001		3.9
2002	3.5	3.3

**Table 4.81: Quantities of Gypsum recovered per tonne of waste treated**

Source: [64, TWGComments, 2003]

### Applicability

Only applicable where wet scrubbing is used.

### Economics

Significant investment is necessary, therefore these procedures are only applicable where sufficient flue-gas loading with sulphur is available.

The economic income benefits of the products may be limited (there are market fluctuations) but waste disposal costs are reduced. Eco-efficiency analysis have shown that these plants are economic compared to other procedures. [64, TWGComments, 2003]

### Driving force for implementation

Availability of outlets for the recovered material.

### Example plants

Seen at incineration plants in Germany.

### Reference literature

[1, UBA, 2001], [64, TWGComments, 2003]



## 4.6 Treatment techniques for solid residues

The possibility of recovering the solid residues from waste incinerators is typically determined by:

- the content of organic compounds in the residues
- the total content of heavy metals in the residues
- the leachability of metals, salts, and heavy metals in the residues
- physical suitability e.g. particle size and strength, of the residues.

In addition, market factors, regulations and policies concerning their use, and specific local environmental issues also impact greatly on the extent to which use is made.

Many efforts have been made to improve the environmental quality of residues from waste incineration and to recycle or utilise at least part of specific residue flows. Both in-process and post-treatment techniques are applied. In-process measures aim at changing the incineration parameters in order to improve burnout or to shift the metal distribution over the various residues. Post-treatment techniques include: ageing, mechanical treatment, washing, thermal treatment and stabilisation. The various techniques will be discussed below.

The *International Ash Working Group* (IAWG) identified a number of principles which have to be considered when assessing the benefits but also the obstacles of a given treatment measure:

- does the process result in a significant quality improvement?
- does the process impose any health, environmental, or safety impacts?
- are there secondary residues and where do they end up?
- is there a final product of high quality?
- is there a long-term market for that product?
- what is the cost of the process?

[4, IAWG, 1997]

For some of the residues produced by the incineration process, specific legislation may require those residues to be disposed of. Where this is the case, there is less incentive for adopting techniques which would improve the quality and recyclability of the residues.

[64, TWGComments, 2003]

### 4.6.1 Improving the burnout of bottom ash

#### Description

Improving the residue burnout can be achieved by the optimisation of combustion parameters in order to bring the fixed carbon combustion to completion. This can be done using one or more of the measures identified in the thermal processing section (see Section 4.2).

Longer exposure of the waste to elevated temperatures in the combustion chamber, higher bed temperatures and physical agitation of the waste all combine to ensure that ashes produced are lower in organic species.

#### Achieved environmental benefits

The organic content of the bottom ash is expressed as TOC or LOI (loss on ignition). These are key parameters for both the disposal and the use of bottom ash. Acceptance criteria for landfills generally state a maximal TOC level; and utilisation criteria generally state either a maximum TOC level or specific limit values for organic compounds. Improving the burnout will lower the residual carbon content and thus the TOC. The TOC is also related to the mobility of heavy metals in the ash. For instance, copper leaches in the form of organo-copper complexes. Improving the burnout will, therefore, also reduce copper leaching.

TOC determination in accordance with the standard EN 13137 also detects elementary carbon as TOC, which does not cause any problems on landfills. The TOC of bottom ashes comprises mainly elementary carbon, but to a certain extent, organic compounds are also found. [74, TWGComments, 2004]

### **Cross-media effects**

An elevation of the combustion temperature, together with the fuel bed temperature, is reported to cause increased formation of CaO in the bottom ash. This causes an increase in the pH value of the bottom ash. The pH value of fresh bottom ashes often exceeds 12 [Vehlow, 2002 #38].

This increase of pH may also increase the solubility of amphoteric metals such as lead and zinc, which are present in high quantity in bottom ashes. The bottom ash pH may decrease after the combustion phase by ageing (see Section 4.6.6). The pH increase may be critical; in particular, as lead is amphoteric it can be dissolved at pH 11 – 12 and then be leached.

The application of pretreatment to increase burnout will incur additional energy consumption (and emissions) at the pretreatment stage, and therefore associated additional cost. These may be very significant where extensive pretreatment is carried out e.g. RDF production.

If additional fuels are required to support the burnout, their consumption is a cross-media impact.

### **Operational data**

See operational data in Section 4.2 on thermal processing.

### **Applicability**

This technique is applicable both in new and existing installations.

### **Economics**

Basic pretreatment (limited shredding of some components or mixing in bunkers) of waste may not be expensive and can have a significant effect on burnout in some cases.

Addition of higher calorific waste streams (e.g. plastics, automotive shredder residues, wood wastes) or fuels to improve burnout can vary greatly in price according to the material required and the possibility of mixing the different streams. This practice may increase CO emissions and reduce the throughput of MSW.

[74, TWGComments, 2004]

Redesign or replacement of combustion chambers and components can be very costly for existing plants, but can be easily considered as part of the overall design concept for all new processes or those being substantially reconstructed.

Optimisation of the plant for different wastes may require additional regulation devices e.g. instrument, control element, control loop etc. These can lead to further costs in addition to any pretreatment.

Some techniques can result in lower organic carbon-in-ash levels than required by EC/2000/76. Significant increases in cost may be seen in order to *guarantee* the lowest TOC levels that are achieved. Reducing carbon levels is not normally a requirement for the re-use of solid wastes. [74, TWGComments, 2004]

### **Driving force for implementation**

Regulations setting limit values on the TOC of residues for its use and disposal.

### **Example plants**

Optimisation of burnout, using various procedures, is part of standard operation control in many European incinerators.

**Reference literature**

[Vehlow, 2002 #38], [64, TWGComments, 2003]

**4.6.2 Segregation of the bottom ash from flue-gas treatment residues****Description**

The mixing of flue-gas treatment residues with bottom ash causes contamination of the bottom ash. Due to the higher metal content, metal leachability and organic content of the FGT residues, the environmental quality of the bottom ash is reduced. This limits the options for the subsequent use of the bottom ash.

Segregation of bottom ashes and FGT residues consists in the separate collection, storage and transport of both residue streams. This involves e.g. dedicated storage silos and containers, and specific handling systems for the fine and dusty FGT residue.

**Achieved environmental benefits**

Segregation of the FGT residue from the bottom ash enables further treatment of the bottom ash (e.g. by dry treatment or by washing out of water soluble salts, heavy metals in the ash extractor) to yield a material for use. A mixed stream does not allow processing into a material for recovery and leaves no other option for the whole residue stream than landfilling. [74, TWGComments, 2004]

Natural building materials e.g. sand, gravel are replaced [74, TWGComments, 2004]

**Cross-media effects**

None identified.

**Operational data**

Separate transport, storage and handling systems are required.

**Applicability**

This technique applies to both new and existing plants.

**Economics**

Cost reductions may be seen where bottom ash use markets exist.

FGT residue disposal may be higher, but volumes are greatly reduced (FGT residue volumes on their own are typically 2 - 3 % of mass of waste input, whereas when combined with bottom ash this will be around 15 %)

**Driving force for implementation**

Increased possibilities for bottom ash recycling and possible cost reductions.

This is current practice, and even required, by regulations in some EU countries.

**Example plants**

Widely adopted practice at incineration plants throughout Europe.

**Reference literature**

[64, TWGComments, 2003]

### 4.6.3 Separation of the dust removal stage from other flue-gas treatments

#### Description

Removal of dusts before the air pollution control stages (those for acid gas and dioxin removal) using ESPs, cyclones or bag filters, without the addition of reagents (additives), allows consideration to be given to the treatment and subsequent recovery of the removed dusts. Where a boiler is installed, the separate collection, transfer and storage of boiler dust serves the same purpose, although with a lower collection efficiency.

The segregated ashes can be returned to the combustion stage for further destruction of any PCDD/F – which may lead to a reduction in the overall dioxin outputs from the installation. However fly ash recirculation may cause risk of fouling in the furnace and occasionally concentration of pollutant contained in the ash. [74, TWGComments, 2004]

#### Achieved environmental benefits

Separation of fly ash and FGT residues may allow their separate further treatment and/or recovery (if allowed by local regulations) and hence reduce quantities requiring final disposal.

It is possible to reduce overall dioxin outputs from the process by reducing outputs in solid residues by fly ash recirculation to the combustor. Non-thermal treatments for fly ashes (either separated fly ash or combined with other treatment residues) generally do not change the overall PCDD/F mass balance but concentrate the PCDD/F into smaller amounts of residues.

#### Cross-media effects

Pre-dedusting may improve the reliability of semi-dry flue-gas cleaning and other FGT systems.

Pre-dedusting with a bag filter will result in higher pressure drops and therefore greater energy consumption than with ESPs.

#### Operational data

Reduced particulate carry over to subsequent abatement stages (especially wet scrubbing systems) may improve their operability and decrease size and costs at that stage.

#### Applicability

Applicable to all new installations and existing processes replacing flue-gas treatment systems.

#### Economics

Cost of additional process units and operating resources may be offset by reduced FGT residue disposal costs.

#### Driving force for implementation

Where local standards for leachability (and content of substances) are such that they allow the inclusion of fly ashes with bottom ashes, the technique will be easy to apply.

High disposal costs for FGT residues will encourage uptake of the technique in order to reduce the total quantities of FGT residues requiring disposal.

The ease of availability (and hence low cost) of disposal options for fly ash/FGT residue mixtures will prevent uptake of the technique.

#### Example plants

Widely used technique at modern waste incineration plants in Europe.

#### Reference literature

From discussions during EIPPCB site visits.  
[64, TWGComments, 2003]

#### 4.6.4 Bottom ash - separation of metals

##### Description

Both ferrous and non-ferrous metals may be extracted from bottom ash.

Ferrous metals separation is performed using a magnet. The ash is spread out on a moving belt or vibrating conveyor and all magnetic particles are attracted by a suspended magnet. This ferrous metals separation may be performed on the raw ash after leaving the ash extractor. Efficient ferrous metals separation requires a multi-step treatment with intermediate size reduction and screening.

Non-ferrous metal separation is performed using an Eddy Current separator. A rapidly rotating coil induces a magnetic field in non-ferrous particles, which causes them to be ejected from the material flow. The technique is effective for particle sizes of 4 – 30 mm and requires a good spreading of the material on the moving belt. The separation is performed after ferrous metals segregation, particle size reduction and screening.

##### Achieved environmental benefits

The separation of metals is a necessary step to allow recycling of the various ash compounds. The ferrous fraction can be recycled, generally after separation of impurities (e.g. dust), as steel scrap for blast furnaces. The non-ferrous metals are processed externally by further separation according to metal type, which may then be re-melted. The resulting ash fraction has a lower metal content and may be processed to yield an inert secondary construction material.

##### Cross-media effects

Ferrous metals separation uses a small amount of energy. Non-ferrous separation requires size separation, size reduction and spreading of the material. This involves electrical energy use.

##### Operational data

The amount of recovered metals depends on the composition of the waste input. For ferrous metals, data from Belgium suggest a recovery rate of 55 – 60 % (mass of metal recovered/mass of metal input). [Vrancken, 2001 #39] This recovery rate is supported by data from IAWG, which give a residual ferrous content of 1.3 % to 25.8 % in bottom ash that is considered for utilisation or disposal. [4, IAWG, 1997].

For non-ferrous metals, using Eddy Current separation after size reduction and screening, allows a 50 % recovery rate (mass recovered/mass input). The actual value is dependent on the operational conditions of the furnace. Non-ferrous metals, such as Pb and Zn, are found in the boiler ash and the flue-gas cleaning residue. Al, Cu, Cr, Ni preferentially stay in the bottom ash. Oxidation of these metals (e.g. Al to  $Al_2O_3$ ) during combustion will hamper the effective separation by Eddy Current separators. The separated non-ferrous fraction shows the following composition: 60 % Al, 25 % other metals, 15 % residue. The other metals are mainly copper, mending, zinc and stainless steel. [Vrancken, 2001 #39]

##### Applicability

Magnetic separation of ferrous metals is applicable in all new and existing installations. Non-ferrous metals separation requires space and sufficient throughput and may be performed by an external (centralised) bottom ash processing installation.

The applicability of the technique is strongly related to the metal content of the waste fed to the furnace. This, in turn, is highly influenced by the collection regime and pretreatment that the waste has undergone before being fed to the furnace. For example, areas with extensive and well adhered to segregation schemes for municipal wastes, may remove significant quantities of metals. Pretreatment of MSW to create RDF will have a similar effect. At some hazardous waste plants shredded drums are removed using magnets prior to combustion.

### **Economics**

The metal fractions can be sold to scrap dealers. Prices depend on the purity (ferrous) and composition (non-ferrous) of the material. Prices for ferrous scrap are determined by stock exchange. Market price for this material is generally in the range of EUR 0.01 – 0.05/kg.

Non-ferrous scrap needs further processing into pre metal fractions. Prices for non-ferrous scrap depend on the amount impurities (i.e. amount of processing needed) and the composition (i.e. price for final products). The content of aluminium and the market price of secondary aluminium are the main determining factors. The price of the non-ferrous fraction from MSW bottom ash treatment is in the range EUR 0.10 – 0.60/kg. [Vrancken, 2001 #39]

### **Driving force for implementation**

Interest of scrap market (i.e. market prices) in the produced fractions.

Increased marketability of cleaned bottom ash. For example, non-ferrous metals may cause damage when re-used in road works, such as swelling.

Specifications for the bottom ash to be recycled may include total metals contents. The most problematic metals from the point of view of leaching from the bottom ash are Cu, Mo and Zn.

### **Example plants**

Ferrous metals separation is performed in most European incinerators either on-site (mainly post combustion) or at external bottom ash treatment plants. [74, TWGComments, 2004]

Non-ferrous metals separation: various bottom ash treatment plants in the Netherlands, Germany, France, and Belgium.

### **Reference literature**

[39, Vrancken, 2001], [4, IAWG, 1997], [64, TWGComments, 2003] [74, TWGComments, 2004]

## **4.6.5 Bottom ash screening and crushing**

### **Description**

The various mechanical treatment operations for bottom ash are intended to prepare materials for road and earthworks construction that possess satisfactory geotechnical characteristics and do not cause damage to the road works. Several operations can occur during the preparation process:

- granulometric separation by screening
- size reduction by crushing large elements or otherwise breaking them up
- air-stream separation to eliminate light unburned fractions.

Three types of screen are encountered:

- rotary or drum screens
- flat screens (vibrating or not)
- star screens: screening is achieved by movement over a series of rollers equipped with star-shaped arms on each axis.

Primary screens used to prepare bottom ash aggregate are in most cases equipped with a mesh sized 40 mm in diameter. This yields 0 – 20 mm aggregate material.

A crusher can be installed in the treatment line to break up large chunks, generally at the exit from the first screening. Half of the facilities are equipped with crushing apparatus, some use equipment at the site (shovel, loader, rock crusher, etc) to smash blocks.

Breaking up large chunks has several advantages:

- it reduces the amount of heavy rejects
- it increases the proportion of rough crushings in the material which give backbone to the aggregate and
- it improves its geotechnical qualities.

Separation of light unburned fractions or air stream separation is achieved by blowing or by aspiration.

#### **Achieved environmental benefits**

The main environmental benefit of installing a mechanical treatment process is a reduction of the volume of rejects and wastes, and therefore, a higher global recovery rate.

#### **Cross-media effects**

Energy consumption, and potential for noise and dust emissions are the most notable cross-media effects.

#### **Applicability**

The technique is, in principle, applicable to all incineration installations producing an ash requiring treatment before it can be used, or where such treatment may allow increased use.

#### **Economics**

The cost-effectiveness of installing a system for breaking up heavy rejects is to be evaluated on the basis of projected quantities and disposal costs. It is estimated that the payback period for a crusher is on the order of two years for 5 % of rejects to be crushed, for 40000 t/yr of bottom ash, and seven years for 20000 t/yr.

#### **Driving force for implementation**

Quality policy: it allows to reach a global recovery rate of more than 95 % for a bottom ash management facility, it produces less rejects and a product of a higher geotechnical quality, and is cost effective.

#### **Reference literature**

[64, TWGComments, 2003] See "Bottom ash management facilities for treatment and stabilisation of incineration bottom ash", ADEME, November 2002

### **4.6.6 Bottom ash treatment using ageing**

#### **Description**

After metals separation, bottom ash may be stored in the open air or in specific covered buildings for several weeks. The storage is generally performed in stockpiles on a concrete floor. Drainage and run-off water are collected for treatment. The stockpiles may be wetted, if required, using a sprinkler or hose system in order to prevent dust formation and emissions and to favour the leaching of salts and the carbonisation if the bottom ashes are not sufficiently wet.

The stockpiles may be turned regularly to ensure homogeneity of the processes that occur during the ageing process (uptake of CO<sub>2</sub> from the air due to the moisture, draining of excess water, oxidation, etc.) and to reduce the residence time of every batch of bottom ash in the dedicated facilities.

In practice an ageing period of 6 to 20 weeks is commonly observed (or prescribed) for treated bottom ash before utilisation as a construction material or in some cases before landfilling. [74, TWGComments, 2004]

In some cases the entire process is performed inside a closed building. This assists with dust, odour, noise (from machinery and vehicles), and leachate control. In other cases, the entire process is totally or partially performed outdoors. This generally allows more space to easily handle bottom ash, and can give more air circulation for bottom ash to mature, [64, TWGComments, 2003] and may avoid the release of explosive hydrogen in combination with aluminium during the ageing process. [74, TWGComments, 2004]

### **Achieved environmental benefits**

Fresh bottom ash is not a chemically inert material. Ageing is performed to reduce both the residual reactivity and the leachability of metals. CO<sub>2</sub> from the air and water from humidity, rain or water spraying are the main activities.

Aluminium in the bottom ash will react with Ca(OH)<sub>2</sub> and water to form aluminium hydroxide and hydrogen gas. The main problem of formation of aluminium hydroxide is the volume increase as this causes inflation of the material. The gas production will cause technical problems if fresh bottom ash is used directly for construction purposes. Thus, ageing is needed to allow utilisation of the bottom ash.

The impact of storage and ageing on leaching can be classified as:

- lowering of the pH due to uptake of CO<sub>2</sub> from the air or biological activity
  - establishing of anoxic, reducing conditions due to biodegradation of residual organic matter
  - local reducing conditions due to hydrogen evolution
  - hydration and other changes in mineral phases causing particle cohesion.
- [4, IAWG, 1997]

All these effects reduce the leachability of metals and cause a stabilisation of the bottom ash. This makes the bottom ash more suited for recovery or disposal (landfilling). [74, TWGComments, 2004]

### **Cross-media effects**

Run-off water from rain or sprinkling may contain salts or metals and will need treatment. The water can be recirculated or used in the incinerator as process water.

Odour and dust controls may be required.

Vehicle and machinery noise may be an issue in some locations.

Anti explosive devices at indoor ageing facilities may be required. [74, TWGComments, 2004]

### **Operational data**

Data from a test programme in a full scale German waste incineration plant illustrate the effect which 12 weeks ageing has on the pH of bottom ashes and on the test results obtained by the DEV S4 method. Figure 4.9(a) shows that the pH of the fresh bottom ashes in the DEV S4 test typically exceeds 12 and drops down by about two units during the ageing process.

As can be seen in Figure 4.9(b), this pH change has no effect on the leaching properties of Mo, which is present mainly as molybdate. The leaching stability of Cu and Zn is moderately improved in the aged material whereas the leaching of Pb is reduced by almost two orders of magnitude.



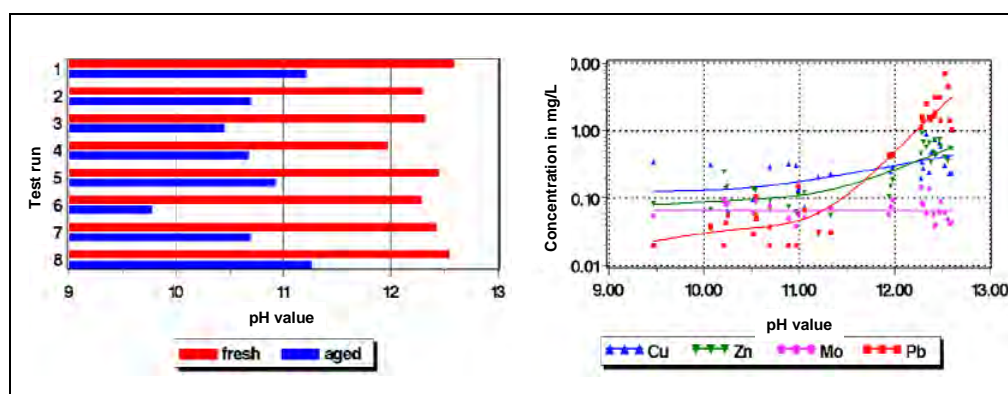

**Figure 4.9: Effect of ageing on the leachability of selected metals: (left) effect on pH; (right) leaching as a function of pH**  
[Vehlow, 2002 #38]

The French Bureau of Mines conducted a study during 18 months about the ageing and its effect on leaching of a 400 tonnes stockpile of bottom ashes and concluded similarly to this German study. [64, TWGComments, 2003]

If longer ageing periods (e.g. >20 weeks) are used for ferrous free bottom ash without turning, the aged bottom ash will become increasingly solidified. [74, TWGComments, 2004]

### Applicability

This technique can be applied to all new and existing installations producing bottom ashes. It is mainly used in practice for MSWI. [74, TWGComments, 2004]

For some waste streams the ash content may not improve sufficiently from treatment to permit its beneficial use – in such cases the driver for use of the technique may be simply to improve disposal characteristics.

### Economics

The cost of ageing is low as compared to the rest of the treatment installation. [74, TWGComments, 2004]

Saving of disposal costs by recycling. [74, TWGComments, 2004]

### Driving force for implementation

Legislation providing leaching limit values for recycling of bottom ash as a secondary raw material or for landfilling. [74, TWGComments, 2004]

### Example plants

Various bottom ash treatment plants in the Netherlands, Germany, France, and Belgium.

### Reference literature

[Vehlow, 2002 #38], [4, IAWG, 1997], [64, TWGComments, 2003]

## 4.6.7 Bottom ash treatment using dry treatment systems

### Description

Dry bottom ash treatment installations combine the techniques of ferrous metals separation, size reduction and screening, non-ferrous metals separation, and ageing of the treated bottom ash. The product is a dry aggregate with controlled grain size (e.g. 0 - 4 mm, 0 - 10 mm, 4 - 10mm), which may be used as a secondary construction material.

The process consists of the following subsequent steps:

- cooling down the temperature of the bottom ash in air
- ferrous metals separation
- sieving
- crushing of coarse fraction
- sieving
- ferrous separation
- non-ferrous separation
- ageing.  
[74, TWGComments, 2004]

### Achieved environmental benefits

The technique produces a material that may be used and reduces the amount of residue for disposal.

### Cross-media effects

The installation consumes electrical energy and may generate dust emissions and noise.

### Operational data

Post-treatment slag quality data are shown in the tables below, for an installation using the following techniques:

- raw slag kept in dry storage for 4- 6 weeks
- preliminary sieving of particles >150mm
- removal of ferrous from <150mm fraction
- further sieve separation (<22mm, 22- 32mm, >32mm)
- <22mm fraction marketed as sand substitute
- >32 mm to hand picking and separators to remove non-incinerable and ferrous fractions, crushing and recirculation
- 22 - 32 mm fraction air separation of light fractions and ferrous removal
- separated metal fractions undergo sieving, cleaning and storage before complete re-pass through the process separately from the slag.

	<b>Output slag content mg/kg</b>
As	150
Cd	10
Cr	600
Cu	600
Pb	1000
Ni	600
Zn	1
Hg	0.01

**Table 4.82: Slag output concentration (mg/kg) data reported for an example slag treatment facility**  
Source: TWG Comments

	Output slag eluate data ug/l
As	-
Cd	5
Cr	200
Cu	300
Pb	50
Ni	40
Zn	300
Hg	1

**Table 4.83: Slag output eluate (ug/l) data reported for an example slag treatment**

Source: TWG Comments

### Applicability

The technique is applicable to new and existing installations. In order to be economically viable, a minimal throughput is needed. For small-scale installations an external (centralised) bottom ash treatment may be used.

### Economics

The main benefit is to avoid disposal costs; apart from that, the economy of the bottom ash treatment operation depends on the market price of the produced fractions. Treated bottom ash will generally be sold, transport included, at zero cost. Revenue is created by the quality of non-ferrous and ferrous metals fractions. Aluminium is the product with the highest market value. The amount and purity of the produced aluminium is an important factor in the overall economics of the installation.

#### Data from a MSWI plant in Sweden using various dry ash treatments and ageing:

The tax for land filling the ash is approximately EUR 40/t

The stone and gravel which is separated at the earlier stages of the treatment process has a commercial value of around EUR 6/t

The commercial value of the treated bottom ash residue as a construction material is around EUR 2.5/t.

#### Data from a MSWI plant in Portugal using ferrous removal and 1-2 days storage prior to landfill:

The cost of depositing the residues in the self owned landfill is approximately EUR 2/t. This site is geographically near the incineration plant and thus transport costs are low.

The cost of depositing the residues in the site owned by the external company is EUR 2/t transport and EUR 9/t disposal – total EUR 11/t.

#### Data from a different MSWI in Portugal using ferrous and non-ferrous removal followed by 3 months stabilisation prior to final landfill:

The commercial value of the ferrous metal is around EUR 102.13/t.

Landfill costs: EUR 28/t

Bottom ash transport to landfill: EUR 3/t

Note: trials are underway with a view to certification of use of ash in road construction.

### Driving force for implementation

Legislation on recycling of residues as secondary raw materials

### Example plants

Several sites in the Netherlands, Germany, Belgium, and France

### Reference literature

[4, IAWG, 1997], [Vrancken, 2001 #39] [64, TWGComments, 2003]

### 4.6.8 Bottom ash treatment using wet treatment systems

#### Description

The use of a wet bottom ash treatment system allows the production of a material for recycling with minimal leachability of metals and anions (e.g. salts). The incineration ashes are treated by size reduction, sieving, washing and metals separation.

The main feature of the treatment is the wet separation of a 0 - 2 mm fraction. As the majority of leachable components and organic compounds remain with the fine fraction, this results in a reduced leachability of the remaining product fraction (>2 mm).

#### Achieved environmental benefits

The technique produces a material that may be used and reduces the amount of residue for disposal.

Wet bottom ash treatment aims to remove metals, in order to reduce both the metal content and metal leaching. Other constituents of concern are soluble salts, mainly alkali and earth-alkali chlorides and sulphates. Approx. 50 % of the chloride content can be reduced by washing the ashes. The simplest way to do this is by washing in the ash quench tank, as is already performed in some German plants.

The sulphate solubility is controlled by the solubility equilibrium of the predominant earth-alkali sulphates. Stabilisation or removal is then difficult. [Vehlow, 2002 #38]

#### Cross-media effects

The wet treatment results in the production of a fine fraction (0 - 2 mm) for disposal or recovery. Depending on the applicable legislation, metal leaching of this fraction may be in excess of the limit values. Additionally a waste water fraction is produced. This waste water may be fed back into the incinerator as process water, if the quality is suitable with the process. [74, TWGComments, 2004]

#### Operational data

The relative yield of the various fractions depends on the waste input composition. Operational data from a working installation are given in Table 4.84.

Residue type	% ( $\frac{\text{mass}_{\text{output}}}{\text{mass}_{\text{bottom ash input}}}$ )
Residue for disposal (0 - 2 mm)	47
Product for re-use (2 - 60 mm)	34
Ferrous metals	12
Non-ferrous metals	2
Unburned back to incinerator	5

**Table 4.84: Relative yield of various output fractions of wet bottom ash treatment**  
[Vrancken, 2001 #39]

Table 4.85 below shows an example of the leaching results of the produced granulates.

	<b>Emission mg/kg. L/S=10 (cumulative)</b>	
	<b>2 – 6 mm granulates</b>	<b>6 – 50 mm granulates</b>
As	0 – 0.1	<0.05
Cd	0 – 0.025	<0.01
Cr	0.005 – 0.053	<0.053
Cu	0.19 – 0.85	0.24 – 0.55
Pb	0.04 – 0.12	<0.10
Ni	0.0007 – 0.005	<0.057
Zn	0.61 – 1.27	<0.16

Note: data from column leaching test NEN7343

**Table 4.85: Example of leaching results of the produced granulates.**  
[64, TWGComments, 2003] TWGComments, 2004 #74]

Other post-treatment slag quality data are shown in Table 4.86 and Table 4.87 below for an installation using the following techniques:

- water washing of slag in incinerator slag bath at furnace exit (water reduces salt levels in slag)
- removal of ferrous and big particles by sieving and hand separation
- storage for >1day for CO<sub>2</sub> reacting
- further sieving, breaking, separation (e.g. >32mm fraction separate milling)
- ferrous and non-ferrous removal
- >10mm fraction is re-circulated after air separation of light (e.g. plastic) fraction
- storage of product for 3 months.

	<b>Output slag content mg/kg</b>	
	<b>Range</b>	<b>Average</b>
As	25 – 187	74
Cd	1.1 - 16.7	3.7
Cr	84 – 726	172
Cu	1676 – 29781	6826
Pb	404 – 4063	1222
Ni	61 – 661	165
Zn	788 – 14356	2970
Hg	0.01 – 0.37	0.7

**Table 4.86: Slag output concentration (mg/kg) data reported for an example slag treatment facility**

	<b>Output slag eluate data ug/l</b>	
	<b>Range</b>	<b>Average</b>
As	<6.0 – 16.1	5.3
Cd	<0.5 – 2.5	0.8
Cr	1 – 113	15.2
Cu	14 – 262	60.7
Pb	8 – 59	11.4
Ni	<4.0 – 11.6	2.9
Zn	<5.0 – 230	19.4
Hg	<0.2 - <0.2	<0.2

**Table 4.87: Slag output eluate (ug/l) data reported for an example slag treatment**

### Applicability

The technique is applicable to new and existing installations. In order to be economically viable, a certain minimum throughput is needed. For small-scale installations an external (centralised) bottom ash treatment is often used.

### Economics

The economy of the bottom ash treatment operation depends on the market price of the produced fractions. Treated bottom ash will generally be sold at zero cost. Revenue is created by the quality of the non-ferrous and ferrous metals fractions. Aluminium is the product with the highest market value. The amount and purity of the produced aluminium is an important factor in the overall economics of the installation.

### Driving force for implementation

Legislation for recycling of residues as secondary raw materials

### Example plants

Indaver, Beveren (B)

### Reference literature

[Vehlow, 2002 #38], [Vrancken, 2001 #39], [4, IAWG, 1997], [64, TWGComments, 2003]

## 4.6.9 Bottom ash treatment using thermal systems

### Description

Various techniques have been adapted from the glass manufacturing and nuclear waste treatment industries for the thermal treatment of ashes. The temperatures applied are in the range of 1100 to 2000 °C. Much higher temperatures are sometimes employed for plasma systems. Plasma systems are used for the vitrification and melting of a variety of inorganic waste streams including bottom and fly ash – temperatures used for plasma arc vitrification are generally in the range of 1400 to 1500 °C, with the power supplied electrically.

The molten products (i.e. slag and metal) may be continuously overflowed or intermittently tapped as required.

### Achieved environmental benefits

This technique results in a reduced volume (reduced by 33 – 50 %), very low leaching, and extremely stable residue, that can be readily recycled as an aggregate.

PCDD/F levels in the treated ash are reduced. The following PCDD/F inputs and emissions are reported for the plasma destruction of MSW incinerator fly ash. Fly ash output arises from the baghouse used to treat process off-gas:

Ash input	50 ngTEQ/g
Slag output	<0.001 ngTEQ/g
Fly ash output	<0.005 ngTEQ/g
Flue-gas output	<0.05 ngTEQ/m <sup>3</sup>

### Cross-media effects

Very high energy consumption is reported 0.7 – 2 kWh./kg of ash treated. [IAWG, 1997 #4]

Power requirements are typically; AC submerged arc furnace 650 – 1000 kWh/t-ash; DC plasma furnace 600 – 800 kWh/t-ash.

In France, a concern is the outlet of the vitrified residue, due to lack of clear regulation. It is not permitted to use it and it must be removed for landfill. The available (permitted) outlet is based on ash origin and not its properties.

The flue-gas issued from thermal treatment of solid residues can itself emit high level of pollutants such as NO<sub>x</sub>, TOC, SO<sub>x</sub>, dust, heavy metals etc. Therefore flue-gas treatment is also required to remove pollutants from the ash treatment stage of gases (or to treat the flue-gas in the FGT of the nearby incinerator plant).

The process is reported to be complex and the availability may be critical. [74, TWGComments, 2004]

### Operational data

Plasma furnaces operate with power densities of 0.25 to 0.5 MW/m<sup>2</sup> and have melting rates of 300 kg/hr/m<sup>2</sup>. Process footprints are usually small.

Tolerance to feedstock variation is reported. Electrode consumption with DC plasma is reported as 2kg/t-ash treated. FGT is required for the process off gases.

### Applicability

Although used in Japan, these techniques have had little penetration into other markets owing principally to their high cost, and perceived lack of benefit when existing systems already produce a product of sufficient quality.

Plasma treatment is applied to the treatment of combined incinerator and fly ashes. If the chemical residues of FGT are added increased FGT is required.

### Economics

Compared to other techniques, external thermal treatment costs are reported to be high.

Treatment technique used	Cost (EUR/t of bottom ash)	Cost (EUR/t of MSW)
Direct landfill	35	12
Pretreatment for utilisation	20	7
Fusion (fossil fuel, no pretreatment)	100	30
Fusion (fossil fuel, scrap removal)	130	45
Fusion (electric heating)	120	40
Fusion processes in Japan	100	30
Fusion processes estimates (IAWG)	180	60

**Table 4.88: Relative costs of some ash treatment techniques**

Source [Vehlow, 2002 #38]

Vitrification costs are highly sensitive to the unit cost of electricity. Treatment costs are reported to be in the range EUR 100 to 600/t of ash. Investment costs can be up to EUR 20 million for a plant of capacity 1 – 1.5 t/hr.

### Driving force for implementation

Implemented where the leaching standards required for recycled aggregates, or for disposal in landfill, are severe.

### Example plants

Many examples in Japan (estimated 30 – 40 plants). Some experience in Europe, e.g. France

### Reference literature

[38, Vehlow, 2002], [4, IAWG, 1997], [64, TWGComments, 2003]

### 4.6.10 High temperature (slagging) rotary kiln

This technique is already described (see comments in Section 4.2.16) in relation to its combustion related impacts. The impact it has upon the solid residue produced are also noted in that section.

### 4.6.11 FGT residue treatments

The following sections refer specifically to the treatment of FGT residues, and not to bottom ash treatment.

It may be noted that in some cases FGT residues are sent for controlled storage e.g. in Salt mines. The scope of this BREF document does not extend to the consideration of such storage and it is not therefore considered any further. It is however noted that such an option is available and permitted in some members states.

#### 4.6.11.1 Cement solidification of FGT residues

##### **Description**

Generally the residues are mixed with mineral or hydraulic binders (e.g. cement, coal fly ash, etc.), additives to control the properties of the cement (generally, to lower the Pb-leachability, silica based reagents are used, and to lower other metals, sulphide based reagents are used), and enough water to ensure that hydration reactions will take place for binding of the cement. The residues are thereby incorporated in the cement matrix. Typically, the residues will react with water and the cement to form metal hydroxides or carbonates which are usually less soluble than the original metal compounds in the residue matrix.

Cement-based solidification techniques rely on equipment that is readily available. The mixing and handling associated with the processes are well developed and the technique is robust with respect to variations in residue characteristics.

The solidified product is generally either landfilled in surface level or underground facilities, or utilised as backfilling material in old salt mines. Note that, in some cases mine deposition is prohibited by locally applicable legislation, in other cases it is carried out by direct filling of untreated residues that are packed into suitable containers (e.g. in big bags).

[64, TWGComments, 2003]

##### **Achieved environmental benefits**

The main advantage of cement solidification is the reduced contact between water and the residue and to some extent the possible formation of less soluble metal hydroxides or carbonates. The solidified product is relatively easy to handle, and the risk of dusting is very low. The release of heavy metals from the products in a short-term perspective is typically relatively low, however, the high pH of cement-based systems can result in significant leaching of amphoteric metals (Pb and Zn).

The drawbacks of this method are that leaching of soluble salts is not hampered and that this will eventually result in physical disintegration of the solidified product, thus allowing further leaching.

The addition of cement and additives increases the amount of waste to be handled; typically about 50 % of the residue dry weight is added as cement and additives and 30 to 100 % of the total dry weight is added as water [4, IAWG, 1997]. Thus, the residue output from fly ash is typically increased from 20 - 30 kg/t waste input to about 40 - 60 kg/t waste, including addition of water corresponding to 50 % of the total dry weight.



**Cross-media effects**

The technique does in some cases facilitate utilisation of the residues as backfilling or construction material in the mining industry.

The use of this technique implies consumption of cement, additives and water.

**Operational data**

Energy and water consumption varies and is not quantified. The operation and control of equipment used by the technique is considered relatively simple and comparable with standard practices in concrete industry.

**Applicability**

Solidification is typically performed at dedicated plants located near the end-destination of the product; thus, individual incinerators have no need to install solidification equipment. The technique can be used on all types of FGT residues. Solidification with cement has also been used on many other types of hazardous wastes, including for the disposal of low-level radioactive waste.

**Economics**

In most cases, the residues can be delivered to existing plants. Treatment costs for cement solidification alone may vary a lot according to the country, and they are estimated to be about EUR 25 per tonne residue [38, Vehlow, 2002].

**Driving force for implementation**

The technique is relatively simple and the necessary technical knowledge is readily available. Also, the leaching characteristics of the solidified product are improved considerably compared to the untreated residues. Stabilisation of FGT residues by cement solidification has also been used and is considered acceptable by authorities in many countries worldwide.

**Example plants**

The technique is probably the most common method for the treatment of FGT residues and is widely used in Europe and Japan.

The main types of cement solidification are listed below:

Country	Characteristics
Germany	Several salt mining companies in Germany accept FGT residues and perform cement solidification on these by using residues as filler material. The solidified residues are chiefly utilised as backfilling material or for reinforcement. Cement solidification is, for some of the mines, performed at one central plant using varying recipes according to final destination and requests. From the central solidification plant, the product is transported to the recipient mine. (Normally the residues are transported to the mines where they are used as filling material for the concrete production needed for the mine.)
Switzerland	A variation of cement solidification is used in Switzerland where residues are washed with water and dewatered prior to mixing with cement. This has the benefit of removing most of the soluble salts from the residues thus improving the longevity of the solidified product. After solidification, the residues are deposited at surface level landfills before hardening. In some plants, the mixture is cast into moulds to produce blocks, that are transported to surface landfills.
Sweden	At one landfill site in Sweden (Hogdalan) cement solidified FGT residues are cast into blocks and placed at a surface level landfill after hardening.
France	Since 1992, FGT residues and fly ash from dust removal treatments have been solidified/stabilised using mineral and hydraulic binders (e.g. cement, coal fly ash, etc.) and additives before landfilling. In 2001, 90 % of the 353 kt of these residues produced were concerned and were treated in 12 plants located in 12 of the 14 French surface level landfills for hazardous waste. Since 2001, two new solidification/stabilisation plants have been created increasing the treatment capacity approximately from 600 kt/yr to 700 kt/yr. No solidified/stabilized wastes are landfilled in mines. In August 2002, a new treatment was industrially implemented : with a capacity of 50 kt/yr, which works on the dry sodium bicarbonate FGT residues to purify them and recycle them in a soda-ash plant; see full description at section 4.6.11.5. [74, TWGComments, 2004]

**Table 4.89: Variations in solidification treatments for FGT residues between some countries**

Source [48, ISWA, 2003], [64, TWGComments, 2003]

#### 4.6.11.2 Vitrification and melting of FGT residues

##### Description

Vitrification and melting result in mobilisation of volatile elements such as Hg, Pb and Zn during the treatment process; this, in some processes, is used in combination with other parameters to produce a recyclable product low in heavy metals.

The techniques employed for vitrification and melting of residues are similar in many respects. The main difference is mainly the cooling process, and also, but less important, the use of specific additives to favour glassy or crystalline matrix.

Several techniques for heating the residues are used: electrical melting systems, fuel fired burner systems and blast melting. They differ in the way energy is transferred and by the oxidation or reduction state during operation and the quantities of off-gas produced.

Generally, techniques are inspired from furnaces used in iron and steel production. In all systems, the residues are fed into a reaction chamber usually by a charger system. The melting process can be operated in such a way that a continuous cooler layer at the top of the smelter is maintained in order to confine the smelting process, or the entire residue amount in the reaction chamber can be in a molten state.

Depending on the melting system, metal alloys can be recovered from the reaction chamber. Zinc (Zn) and lead (Pb) can be recovered. Depending on the temperatures in the reaction chamber and the state of oxidation or reduction of the gas phase, heavy metals (especially Cd and Pb) will be volatilised and removed by the off-gas. All process configurations need off-gas treatment systems to reduce emissions.

Working in oxidising conditions avoids the separation of phases and the formation of metal droplets in the melt, whereas reducing conditions enhance phase separation and metal segregation and volatilisation.

For burner driven processes, the process conditions are mostly neutral but the off-gas volumes are huge. Consequently the off-gas or fume treatment equipment has to be oversized.

For electric driven processes, i.e. resistor heating, electric arc or transferred arc plasma torches, the process conditions are reducing. The fume volume is small but this can be problematic too, because the concentration of metals and other volatilised substances in the off-gas is very high and condensation may occur in the fume duct. Often carrier gas is introduced to avoid this phenomenon.

With plasma torches (i.e. non transferred arc plasma torches) the process conditions are strongly oxidising. The fumes volume is medium, no carrier gas is needed, and the size of fume treatment equipments remains reasonable.

#### **Achieved environmental benefits**

Melted and vitrified products generally have very good leaching properties. Swiss studies where vitrified, vitro-crystalline and so-called sintered products were tested, have shown that sintered products also tend to reach the same level of stability with regard to leaching. Vitrification typically yields the most stable and dense products. Generally, organic compounds such as dioxins are destroyed in the process.

An inherent advantage of these processes is the destruction of organic pollutants such as dioxins. Due to the release of vaporised heavy metals from the process, thermal treatment requires an additional flue-gas treatment system, which can take place on the same FGT facilities of the MSW incineration plant.

A major drawback to these methods, is that they require substantial amounts of energy and may, therefore be costly. There may also be a problem of a market outlet for these treated residues.

#### **Cross-media effects**

Vitrification and melting result in mobilisation of volatile elements such as Hg, Pb and Zn during the treatment process.

Thermal treatment processes use very substantial amounts of energy. Additionally, the processes produce solid residues from off-gas treatment. The flue-gas issued from thermal treatment of solid residues emit pollutants such as NO<sub>x</sub>, TOC, SO<sub>x</sub>, dust, heavy metals etc. and flue-gas treatment is required to remove those pollutants (or treat the flue-gas in the FGT of the nearby incinerator plant when possible).

There may also be a problem of a market outlet for the treated residues. These residues have a limited use in comparison with granulates coming from cold bottom ash treatment installations; the reason for this being the physical constitution which does not allow great stability in building/construction applications.

#### **Operational data**

Typically, approx. 700 - 1200 kWh/t is used of treated residue to reach and maintain the elevated temperatures, but up to approx. 8000 kWh/t has been reported (Ecke et al., 2000). Energy consumption and operation varies with furnace type and plant design.

Usually, the residue input must comply with certain quality requirements, for example: water content <5 %, unburned contents <3 %, metal content <20 % by weight, and ash size <100 mm (Kinto, 1996). Thermal treatment facilities in general reduce residue volume to about one fifth of the input volume (TWGComments 2003). Melting increases the density of the products to typically 2.4 - 2.9 t/m<sup>3</sup>.

It is reported that these processes may be complex and the availability critical.

### Applicability of the technique

Thermal treatment is widely used, mostly in Japan and the US, for treatment of bottom ashes as well as combinations of bottom ash and FGT residues. Due to high contents of salts and heavy metals in the FGT residues, separate treatment of FGT residues can cause need for extensive off-gas treatment, thus, reducing the overall benefits of separately treating these residues.

### Economics

Typically, the technique is expensive compared to other treatment options. Treatment costs are reported to be in the order of EUR 100 - 600/t of residue [4, IAWG, 1997, 38, Vehlow, 2002], Ecke et al., 2001. Investment costs can be about EUR 10 - 20 million for a plant with a capacity of 1 - 2 t/hr.

### Driving force for implementation

The main reason for implementing the technique is good leaching properties of the final product, transforming the toxic residue into an inert product, especially for vitrifying; and the significant reduction in volume.

In densely populated areas, such as Japan, landfill capacity can be a scarce resource and landfilling, thus, relatively costly. Organic compounds, such as dioxins and furans (with municipal waste, 90 % or more of the dioxins and furans produced during incineration, are concentrated in the FGT residues and fly ashes) are almost completely destroyed and the inorganic compounds (i.e. heavy metals) are closely bonded at the atomic scale, in an durable matrix with a very long lifetime.

### Example plants

Thermal treatment including melting and vitrification is mostly used in Japan where it is estimated that about 30 - 40 plants are operated, however examples in the US and Europe can also be found [4, IAWG, 1997]

Country	Characteristics			
US	A vitrification process proposed by Corning, Inc. [4, IAWG, 1997] includes initial steps of water extraction, dewatering and drying at 500 °C before addition of glass forming additives and melting. The initial washing and drying was done to remove chlorides and residual organic carbon.			
Japan	According to Ecke et al. (2000) and Sakai and Hiraoka (1997) plants for thermal treatment of both bottom ash and FGT residues included:			
		In operation	Planned	Capacity (tonne/day)
	<i>Electric melting:</i>			
	Electric arc	4	2	655
	Plasma arc	4	2	183
	Electric Resistance	2	3	148
	<i>Burner:</i>			
	Reflecting surface	12		209
	Rotating surface	5		84
	<i>Blast melting:</i>			
	Coke bed	3		170
Residual carbon combustion	1		15	
<b>Total</b>	<b>31</b>	<b>7</b>	<b>1464</b>	

Table 4.90: FGT vitrification processes used in the US and Japan [48, ISWA, 2003]

A 0.5 MW plasma melting process treating both fly ash and bottom ash has been operational in Cenon, near Bordeaux, France, since 1997. It is reported that this plant does not treat bottom ash but only fly ash from the electrostatic precipitator. In addition, the boiler ash cannot be treated because of the sulphur and halogen content.

#### Reference literature

[64, TWGComments, 2003], [48, ISWA, 2003]

#### 4.6.11.3 Acid extraction of boiler and fly ash

##### Description

Boiler and fly ash are treated with the acidic effluent from the first (acidic) stage of a wet scrubber. The treated residues are then washed and normally remixed with bottom ash prior to landfill disposal. [64, TWGComments, 2003]

This process, known as the FLUWA process, combines an acid extraction of soluble heavy metals and salts by using the (acidic) scrubber blowdown. Before using the scrubber liquid, mercury is removed by either a filtration (when activated carbon is introduced into the scrubber) and/or a specific ion exchanger. Both boiler ash and fly ash are treated this way. The L/S-ratio in the extraction step is approx. 4; pH is controlled at 3.5 by the addition of hydrated lime. Within the residence time of approx. 45 minutes, sulphate (from the SO<sub>2</sub>-scrubber) is precipitated to gypsum. The residue is dewatered, then countercurrent washed on a belt filter and finally landfilled, normally as a mixture with bottom ash.

The filtrate has to be treated in order to remove the heavy metals by neutralisation, precipitation and ion exchange. The dewatered and rinsed filter cake contains about 25 % zinc and is, therefore, recycled in metallurgical processes.

##### Achieved environmental benefits

The process removes a significant part of the total amount of heavy metals from the residues (Cd: ≥85 %; Zn: ≥85 %; Pb, Cu: ≥33 %; Hg: ≥95 %). The leachability of the residue is reduced by a factor 10<sup>2</sup> – 10<sup>3</sup>. Zinc, cadmium and mercury are recycled. Ecotoxicity tests (MICROTOX, Ceriodaohnia, Algae growth, mortality of worms & lettuce germination) are reported to be positive. [74, TWGComments, 2004]

##### Cross-media effects

The dioxin content of the bottom ash increases when the treated ash is disposed combined with bottom ash; however, the leaching properties of the mixture are even better because of the higher density.

Salt and metals from the FGT residues are transferred to a waste water stream, that may then require treatment before discharge.

##### Operational data

Start-up of the first plant was 1996. Most of the plants operate 24 hr/d and adapt the weekly operational period (4 – 7 days) according to the arising FGT residues.

##### Applicability of the technique

The system can be used only on incinerators with a wet FGT system that can discharge the treated waste water.

##### Economics

Process costs of treating the FGT residues: about EUR 150 – 250/t (including charges for recycling the zinc filter cake, equivalent to EUR 10 - EUR 13/ t of waste). [74, TWGComments, 2004]

### Driving force of implementation

The technique provides a method to treat residues according to the Swiss legislation, and at a competitive price to the main alternative option, which is to export to German mines.

### Example plants

Plant (all MSW)	Country	Start-up year
Berne	Switzerland	1996
Buchs SG	Switzerland	1997
Emmenspitz	Switzerland	1998
Liberec	Czech Republic	1999
Niederurnen	Switzerland	2001
Thun	Switzerland	2003
Lausanne	Switzerland	2005

**Table 4.91: Examples of plants using the acid extraction process for FGT residue treatment** ([ISWA, 2003 #48])

A number of other more or less similar techniques also make use of acid extraction.

Process	Characteristics
<b>MR</b>	The MR-process, (Stubenvoll, 1989) similar to the 3R-process, combines acid extraction with thermal treatment. First boiler and fly ash is washed with the first stage wet scrubber solution and dewatered. Then the residues are treated in a rotary kiln for one hour at approx. 600 °C destroying dioxins and volatilise Hg. The off-gas is treated in an activated coal filter. The waste water is treated to remove heavy metals. The scrubber solution from the second scrubber is used to wash bottom ash and neutralise acidic effluent streams [4, IAWG, 1997].
<b>AES</b>	The Acid Extraction Sulphide process (AES) combines fly ash and NaOH-scrubber solution with water at L/S 5. After mixing, the pH is adjusted to about 6 – 8 with HCl to extract heavy metals, and NaHS is added to bind heavy metals as sulphides. Then a coagulation agent is added and the slurry is dewatered. The filter cake is landfilled, and the waste water is treated in a subsequent treatment unit to remove heavy metals ([4, IAWG, 1997]; Inoue and Kawabata, 1997).
<b>3 R Process</b>	The 3R process (Vehlow et. al. 1990) is similar to the FLUWA process by using acid scrubber solution to extract heavy metals followed by a dewatering step. However, the solids are returned to the combustion chamber. Similar to the FLUWA-process, the produced waste water requires treatment.

**Table 4.92: Characteristics of some acid extraction processes used for FGT residue treatment** Source [48, ISWA, 2003]

### Reference literature

[48, ISWA, 2003, 64, TWGComments, 2003]

#### 4.6.11.4 Treatment of FGT residues arising from dry sodium bicarbonate FGT process for use in the soda ash industry

##### Description

The FGT residues from dry sodium bicarbonate FGT are stored in silos pending treatment. The residues are then dissolved with a controlled pH and with certain additives. The suspension formed is passed through a filter press which separates out the insoluble: heavy metal hydroxides, activated carbon and fly ashes. In this way, a raw brine and a filtration cake are obtained.

The raw brine then passes through a sand filter and into a column of activated carbon which absorbs any organic compounds which may be present. The final traces of heavy metals are eliminated in two ion-exchange resin columns in order to achieve a grade of NaCl brine of a quality that may be used in an industrial soda ash process.

The filtration cake, which is the only remaining waste, is landfilled. The total amount is no more than 2 to 4 kg per tonne of incinerated MSW.

The purified brine and the filtration cake are the only end-products. The washing water, the resin regeneration reagents, etc. are fully recycled in the dissolution process, so the plant does not produce any aqueous waste.

#### **Achieved environmental benefits**

Treatment of the residues reduces the final quantity requiring landfill.

The brine produced may be used in an industrial soda ash process.

#### **Cross-media effects**

The process requires additional energy and raw material consumption.

Care is required to ensure pollutants captured in the FGT residues are not remobilised for release to the environment.

The technique generates a small amount of residue which may then help to reduce transport requirements. [74, TWGComments, 2004]

#### **Operational data**

The plant is managed according to a quality management system, which assures, among others, the raw materials control on one side, and the purified brine control on the other.

On arrival at the plant, the sodium based FGT residues are analysed to check that their composition matches the acceptance specifications.

The purified brine produced by the installation is regularly analysed for conformity with specifications before being sent to the soda ash production unit.

#### **Applicability**

Only applicable to the residues arising from the dry sodium bicarbonate FGT system.

#### **Economics**

The technique is patented.

When compared to the solidification and landfilling of FGT residues:

- (1) the solidification is eased by the separation of the soluble fraction, and
- (2) the quantity of ultimate residues is reduced.

The process is competitive with alternatives in some countries.

Operational costs are reported to be low and investment costs of the treatment plant are the key factor – to minimise this, the process may be implemented in centralized units serving numerous incineration plants. [74, TWGComments, 2004]

#### **Driving force for implementation**

High disposal costs for FGT treatment residues are an important driver for the use of the process.

### **Example plants**

The industrial pilot plant was designed to demonstrate the feasibility of the purification and recycling process, at a mid scale. Its design capacity was, therefore, of 350 kg residues/h, or 2800 tonnes/yr. Practically, after some extension works, the platform now has a permit for the processing of 13000 t/yr. It is the main service provider for various Italian incineration plants.

### **Reference literature**

[59, CEFIC, 2002, 64, TWGComments, 2003, 73, Rijpkema, 2000]

#### **4.6.11.5 Treatment of FGT residues arising from dry sodium bicarbonate FGT process using hydraulic binders**

##### **Description**

The FGT residues from dry sodium bicarbonate FGT are stored in silos pending treatment. Then the residues are mixed with hydraulic binders, and then placed in an aqueous solution with certain additives. The suspension formed in this way passes through a filter press which separates out the insolubles (containing in particular most of the heavy metals). The resulting products are brine and a filter cake.

The brine is then further purified so that it may be re-used in the manufacture of sodium carbonate (soda ash).

The filtration cake containing hydraulic binders solidifies into an inert matter (according to French standards) which is appropriate for tipping on an adequate landfill site.

The process does not produce any liquid waste: the only outgoing flows are the recyclable brine and the filtration cake.

##### **Achieved environmental benefits**

The purified salts are recycled in a closely located soda ash plant, in the form of brine, replacing part of the salt supply to this soda ash plant.

The ultimate residues are already stabilised and solidified when they go out of the plant, and they are transported to a licensed landfill for storage.

##### **Cross-media effects**

The technique generates a small amount of residue. Transport can limit the use of this technique as it depends on the distance between the incinerator and the residue treatment unit. Moreover to recover the brine the unit of production of bicarbonate should also be located nearby to minimise transport impacts. [74, TWGComments, 2004]

##### **Operational data**

The plant is managed according to a quality management system, which assures, among others, the raw materials control on one side, and the purified brine control on the other.

On arrival at the plant, the residues are analysed to check that their composition matches the acceptance specifications.

The purified brine produced by the installation is regularly analysed for conformity with specifications before being sent to the soda ash production unit.

##### **Applicability**

Only applicable to the residues arising from the dry sodium bicarbonate FGT system.



**Economics**

This technology is patented.

When compared to the solidification and landfilling of FGT residues:

- (1) the solidification is eased by the separation of the soluble fraction, and
- (2) the quantity of ultimate residues is reduced.

The process is competitive with alternatives in some countries.

Operational costs are reported to be low and investment costs of the treatment plant are the key factor – to minimise this, the process may be implemented in centralized units serving numerous incineration plants. [74, TWGComments, 2004]

**Driving force for implementation**

High disposal costs for FGT treatment residues are an important driver for the use of the process.

**Example plants**

This plant is based in France and has a capacity of 50 kt/yr of flue-gas cleaning residues.

**Reference literature**

[59, CEFIC, 2002, 64, TWGComments, 2003, 73, Rijpkema, 2000]

## 4.7 Noise

The noise aspects of waste incineration are comparable with other heavy industries and with power generation plants. It is common for municipal waste incineration plants to be installed in completely closed buildings. This normally includes reception and unloading of waste, mechanical pretreatment, flue-gas treatment, treatment of residues etc. generally with only cooling facilities and long-time storage of bottom ash in the open air.

The most important sources of external noise are:

- trucks for the transport of waste, chemicals and residues
  - crane operations in the bunker
  - mechanical pretreatment of waste
  - exhaust fans, extracting flue-gases from the incineration process and resulting in noise from the outlet of the stack
  - noise, related to the cooling system (for evaporation cooling and especially for air cooling)
  - noise related to transport and treatment of bottom ash (if on the same site)
  - noise from the turbine-generator set.
- [74, TWGComments, 2004]

Other installation parts are usually not significant for external noise production but may contribute to a general external noise production by the plant buildings.

The areas of incineration installations that are the main sources of noise, the noise levels they give rise to and some specific noise abatement techniques are described in Table 3.49

The degree of noise protection and measures taken are often very specific to the location and risk of impacts.

## 4.8 Environmental management tools

### Description

The best environmental performance is usually achieved by the installation of the best technology and its operation in the most effective and efficient manner. This is recognised by the IPPC Directive definition of ‘techniques’ as “*both the technology used and the way in which the installation is designed, built, maintained, operated and decommissioned*”.

For IPPC installations an Environmental Management System (EMS) is a tool that operators can use to address these design, construction, maintenance, operation and decommissioning issues in a systematic, demonstrable way. An EMS includes the organisational structure, responsibilities, practices, procedures, processes and resources for developing, implementing, maintaining, reviewing and monitoring the environmental policy. Environmental Management Systems are most effective and efficient where they form an inherent part of the overall management and operation of an installation.

Within the European Union, many organisations have decided on a voluntary basis to implement environmental management systems based on EN ISO 14001:1996 or the EU Eco-management and audit scheme EMAS. EMAS includes the management system requirements of EN ISO 14001, but places additional emphasis on legal compliance, environmental performance and employee involvement; it also requires external verification of the management system and validation of a public environmental statement (in EN ISO 14001 self-declaration is an alternative to external verification). There are also many organisations that have decided to put in place non-standardised EMSs.

While both standardised systems (EN ISO 14001:1996 and EMAS) and non-standardised (“customised”) systems in principle take the *organisation* as the entity, this document takes a more narrow approach, not including all activities of the organisation e.g. with regard to their products and services, due to the fact that the regulated entity under the IPPC Directive is the *installation* (as defined in Article 2).

An environmental management system (EMS) for an IPPC installation can contain the following components:

- (a) definition of an environmental policy
- (b) planning and establishing objectives and targets
- (c) implementation and operation of procedures
- (d) checking and corrective action
- (e) management review
- (f) preparation of a regular environmental statement
- (g) validation by certification body or external EMS verifier
- (h) design considerations for end-of-life plant decommissioning
- (i) development of cleaner technologies
- (j) benchmarking.

These features are explained in somewhat greater detail below. For detailed information on components (a) to (g), which are all included in EMAS, the reader is referred to the reference literature indicated below.

(a) Definition of an environmental policy

Top management are responsible for defining an environmental policy for an installation and ensuring that it:

- is appropriate to the nature, scale and environmental impacts of the activities
- includes a commitment to pollution prevention and control
- includes a commitment to comply with all relevant applicable environmental legislation and regulations, and with other requirements to which the organisation subscribes
- provides the framework for setting and reviewing environmental objectives and targets
- is documented and communicated to all employees
- is available to the public and all interested parties.

(b) Planning

- procedures to identify the environmental aspects of the installation, in order to determine those activities which have or can have significant impacts on the environment, and to keep this information up-to-date
- procedures to identify and have access to legal and other requirements to which the organisation subscribes and that are applicable to the environmental aspects of its activities
- establishing and reviewing documented environmental objectives and targets, taking into consideration the legal and other requirements and the views of interested parties
- establishing and regularly updating an environmental management programme, including designation of responsibility for achieving objectives and targets at each relevant function and level as well as the means and timeframe by which they are to be achieved.

(c) Implementation and operation of procedures

It is important to have systems in place to ensure that procedures are known, understood and complied with, therefore effective environmental management includes:

(i) Structure and responsibility

- defining, documenting and communicating roles, responsibilities and authorities, which includes appointing one specific management representative
- providing resources essential to the implementation and control of the environmental management system, including human resources and specialised skills, technology and financial resources.

(ii) Training, awareness and competence

- identifying training needs to ensure that all personnel whose work may significantly affect the environmental impacts of the activity have received appropriate training.

(iii) Communication

establishing and maintaining procedures for internal communication between the various levels and functions of the installation, as well as procedures that foster a dialogue with external interested parties and procedures for receiving, documenting and, where reasonable, responding to relevant communication from external interested parties.

(iv) Employee involvement

involving employees in the process aimed at achieving a high level of environmental performance by applying appropriate forms of participation such as the suggestion-book system or project-based group works or environmental committees.

(v) Documentation

establishing and maintaining up-to-date information, in paper or electronic form, to describe the core elements of the management system and their interaction and to provide direction to related documentation.

(vi) Efficient process control

adequate control of processes under all modes of operation, i.e. preparation, start-up, routine operation, shutdown and abnormal conditions

identifying the key performance indicators and methods for measuring and controlling these parameters (e.g. flow, pressure, temperature, composition and quantity)

documenting and analysing abnormal operating conditions to identify the root causes and then addressing these to ensure that events do not recur (this can be facilitated by a 'no-blame' culture where the identification of causes is more important than apportioning blame to individuals).

(vii) Maintenance programme

establishing a structured programme for maintenance based on technical descriptions of the equipment, norms etc. as well as any equipment failures and consequences

supporting the maintenance programme by appropriate record keeping systems and diagnostic testing

clearly allocating responsibility for the planning and execution of maintenance.

(viii) Emergency preparedness and response

establishing and maintaining procedures to identify the potential for and response to accidents and emergency situations, and for preventing and mitigating the environmental impacts that may be associated with them.

Checking and corrective action

(i) Monitoring and measurement

establishing and maintaining documented procedures to monitor and measure, on a regular basis, the key characteristics of operations and activities that can have a significant impact on the environment, including the recording of information for tracking performance, relevant operational controls and conformance with the installation's environmental objectives and targets (*see also the Reference document on Monitoring of Emissions*)

establishing and maintaining a documented procedure for periodically evaluating compliance with relevant environmental legislation and regulations.

(ii) Corrective and preventive action

establishing and maintaining procedures for defining responsibility and authority for handling and investigating non-conformance with permit conditions, other legal requirements as well as objectives and targets, taking action to mitigate any impacts caused and for initiating and completing corrective and preventive action that are appropriate to the magnitude of the problem and commensurate with the environmental impact encountered.

(iii) Records

establishing and maintaining procedures for the identification, maintenance and disposition of legible, identifiable and traceable environmental records, including training records and the results of audits and reviews.

## (iv) Audit

establishing and maintaining (a) programme(s) and procedures for periodic environmental management system audits that include discussions with personnel, inspection of operating conditions and equipment and reviewing of records and documentation and that results in a written report, to be carried out impartially and objectively by employees (internal audits) or external parties (external audits), covering the audit scope, frequency and methodologies, as well as the responsibilities and requirements for conducting audits and reporting results, in order to determine whether or not the environmental management system conforms to planned arrangements and has been properly implemented and maintained

completing the audit or audit cycle, as appropriate, at intervals of no longer than three years, depending on the nature, scale and complexity of the activities, the significance of associated environmental impacts, the importance and urgency of the problems detected by previous audits and the history of environmental problems - more complex activities with a more significant environmental impact are audited more frequently having appropriate mechanisms in place to ensure that the audit results are followed up.

## (v) Periodic evaluation of legal compliance

reviewing compliance with the applicable environmental legislation and the conditions of the environmental permit(s) held by the installation  
documentation of the evaluation.

## (d) Management review

- reviewing, by top management, at intervals that it determines, the environmental management system, to ensure its continuing suitability, adequacy and effectiveness
- ensuring that the necessary information is collected to allow management to carry out this evaluation
- documentation of the review.

## (e) Preparation of a regular environmental statement

- preparing an environmental statement that pays particular attention to the results achieved by the installation against its environmental objectives and targets. It is regularly produced - from once a year to less frequently depending on the significance of emissions, waste generation etc. It considers the information needs of relevant interested parties and it is publicly available (e.g. in electronic publications, libraries etc.).

When producing a statement, the operator may use relevant existing environmental performance indicators, making sure that the indicators chosen:

- i. give an accurate appraisal of the installation's performance
- ii. are understandable and unambiguous
- iii. allow for year on year comparison to assess the development of the environmental performance of the installation
- iv. allow for comparison with sector, national or regional benchmarks as appropriate
- v. allow for comparison with regulatory requirements as appropriate.

## (f) Validation by certification body or external EMS verifier

- having the management system, audit procedure and environmental statement examined and validated by an accredited certification body or an external EMS verifier can, if carried out properly, enhance the credibility of the system.

### (g) Design considerations for end-of-life plant decommissioning

- giving consideration to the environmental impact from the eventual decommissioning of the unit at the stage of designing a new plant, as forethought makes decommissioning easier, cleaner and cheaper
- decommissioning poses environmental risks for the contamination of land (and groundwater) and generates large quantities of solid waste. Preventive techniques are process-specific but general considerations may include:
  - i. avoiding underground structures
  - ii. incorporating features that facilitate dismantling
  - iii. choosing surface finishes that are easily decontaminated
  - iv. using an equipment configuration that minimises trapped chemicals and facilitates drain-down or washing
  - v. designing flexible, self-contained units that enable phased closure
  - vi. using biodegradable and recyclable materials where possible.

### (h) Development of cleaner technologies

- environmental protection should be an inherent feature of any process design activities carried out by the operator, since techniques incorporated at the earliest possible design stage are both more effective and cheaper. Giving consideration to the development of cleaner technologies can for instance occur through R and D activities or studies. As an alternative to internal activities, arrangements can be made to keep abreast with - and where appropriate - commission work by other operators or research institutes active in the relevant field.

### (i) Benchmarking, i.e.

- carrying out systematic and regular comparisons with sector, national or regional benchmarks, including for energy efficiency and energy conservation activities, choice of input materials, emissions to air and discharges to water (using for example the European Pollutant Emission Register, EPER), consumption of water and generation of waste.

### **Standardised and non-standardised EMSs**

An EMS can take the form of a standardised or non-standardised (“customised”) system. Implementation and adherence to an internationally accepted standardised system such as EN ISO 14001:1996 can give higher credibility to the EMS, especially when subject to a properly performed external verification. EMAS provides additional credibility due to the interaction with the public through the environmental statement and the mechanism to ensure compliance with the applicable environmental legislation. However, non-standardised systems can in principle be equally effective provided that they are properly designed and implemented.

### **Main achieved environmental benefits**

Implementation of and adherence to an EMS focuses the attention of the operator on the environmental performance of the installation. In particular, the maintenance of and compliance with clear operating procedures for both normal and abnormal situations and the associated lines of responsibility should ensure that the installation’s permit conditions and other environmental targets and objectives are met at all times.

Environmental management systems typically ensure the continuous improvement of the environmental performance of the installation. The poorer the starting point is, the more significant short-term improvements can be expected. If the installation already has a good overall environmental performance, the system helps the operator to maintain the high performance level.

**Cross-media effects**

Environmental management techniques are designed to address the overall environmental impact, which is consistent with the integrated approach of the IPPC Directive.

**Operational data**

No specific information reported.

**Applicability**

The components described above can typically be applied to all IPPC installations. The scope (e.g. level of detail) and nature of the EMS (e.g. standardised or non-standardised) will generally be related to the nature, scale and complexity of the installation, and the range of environmental impacts it may have.

**Economics**

It is difficult to accurately determine the costs and economic benefits of introducing and maintaining a good EMS. A number of studies are presented below. However, these are just examples and their results are not entirely coherent. They might not be representative for all sectors across the EU and should thus be treated with caution.

A Swedish study carried out in 1999 surveyed all 360 ISO-certified and EMAS-registered companies in Sweden. With a response rate of 50 %, it concluded among other things that:

- the expenses for introducing and operating EMS are high but not unreasonably so, save in the case of very small companies. Expenses are expected to decrease in the future
- a higher degree of co-ordination and integration of EMS with other management systems is seen as a possible way to decrease costs
- half of all the environmental objectives and targets give payback within one year through cost savings and/or increased revenue
- the largest cost savings were made through decreased expenditure on energy, waste treatment and raw materials
- most of the companies think that their position on the market has been strengthened through the EMS. One-third of the companies report increasing revenue due to EMS.

In some Member States reduced supervision fees are charged if the installation has a certification.

A number of studies<sup>7</sup> show that there is an inverse relationship between company size and the cost of implementing an EMS. A similar inverse relationship exists for the payback period of invested capital. Both elements imply a less favourable cost-benefit relationship for implementing an EMS in SMEs compared to larger companies.

According to a Swiss study, the average cost for building and operating ISO 14001 can vary:

- for a company with between 1 and 49 employees: CHF 64000 (EUR 44000) for building the EMS and CHF 16000 (EUR 11000) per year for operating it
- for an industrial site with more than 250 employees: CHF 367000 (EUR 252000) for building the EMS and CHF 155000 (EUR 106000) per year for operating it.

These average figures do not necessarily represent the actual cost for a given industrial site because this cost is also highly dependent on the number of significant items (pollutants, energy consumption...) and on the complexity of the problems to be studied.

7) E.g. Dyllick and Hamschmidt (2000, 73) quoted in Klemisch H. and R. Holger, *Umweltmanagementsysteme in kleinen und mittleren Unternehmen - Befunde bisheriger Umsetzung*, KNI Papers 01/02, January 2002, p 15; Clausen J., M. Keil and M. Jungwirth, *The State of EMAS in the EU. Eco-Management as a Tool for Sustainable Development - Literature Study*, Institute for Ecological Economy Research (Berlin) and Ecologic - Institute for International and European Environmental Policy (Berlin), 2002, p 15.

A recent German study (Schaltegger, Stefan and Wagner, Marcus, *Umweltmanagement in deutschen Unternehmen - der aktuelle Stand der Praxis*, February 2002, p. 106) shows the following costs for EMAS for different branches. It can be noted that these figures are much lower than those of the Swiss study quoted above. This is a confirmation of the difficulty to determine the costs of an EMS.

### Costs for building (EUR):

minimum	-	18750
maximum	-	75000
average	-	50000

### Costs for validation (EUR):

minimum	-	5000
maximum	-	12500
average	-	6000

A study by the German Institute of Entrepreneurs (Unternehmerinstitut/Arbeitsgemeinschaft Selbständiger Unternehmer UNI/ASU, 1997, *Umweltmanagementbefragung - Öko-Audit in der mittelständischen Praxis - Evaluierung und Ansätze für eine Effizienzsteigerung von Umweltmanagementsystemen in der Praxis*, Bonn.) gives information about the average savings achieved for EMAS per year and the average payback time. For example, for implementation costs of EUR 80000 they found average savings of EUR 50000 per year, corresponding to a payback time of about one and a half years.

External costs relating to verification of the system can be estimated from guidance issued by the International Accreditation Forum (<http://www.iaf.nu>).

### **Driving forces for implementation**

Environmental management systems can provide a number of advantages, for example:

- improved insight into the environmental aspects of the company
- improved basis for decision-making
- improved motivation of personnel
- additional opportunities for operational cost reduction and product quality improvement
- improved environmental performance
- improved company image
- reduced liability, insurance and non-compliance costs
- increased attractiveness for employees, customers and investors
- increased trust of regulators, which could lead to reduced regulatory oversight
- improved relationship with environmental groups.

### **Example plants**

The features described under (a) to (e) above are elements of EN ISO 14001:1996 and the European Community Eco-Management and Audit Scheme (EMAS), whereas the features (f) and (g) are specific to EMAS. These two standardised systems are applied in a number of IPPC installations. As an example, 357 organisations within the EU chemical and chemical products industry (NACE code 24) were EMAS registered in July 2002, most of which operate IPPC installations.

In the UK, the Environment Agency of England and Wales carried out a survey among IPC (the precursor to IPPC) regulated installations in 2001. It showed that 32 % of respondents were certified to ISO 14001 (corresponding to 21 % of all IPC installations) and 7 % were EMAS registered. All cement works in the UK (around 20) are certified to ISO 14001 and the majority are EMAS registered. In Ireland, where the establishment of an EMS (not necessarily of a standardised nature) is required in IPC licenses, an estimated 100 out of approximately 500 licensed installations have established an EMS according to ISO 14001, with the other 400 installations having opted for a non-standardised EMS.



**Reference literature**

(Regulation (EC) No 761/2001 of the European parliament and of the council allowing voluntary participation by organisations in a Community eco-management and audit scheme (EMAS), OJ L 114, 24/4/2001, [http://europa.eu.int/comm/environment/emas/index\\_en.htm](http://europa.eu.int/comm/environment/emas/index_en.htm))

(EN ISO 14001:1996, <http://www.iso.ch/iso/en/iso9000-14000/iso14000/iso14000index.html>; <http://www.tc207.org>)

## 4.9 Good practice for public awareness and communication

Public acceptance of incineration plants varies greatly from one location to another. Developers sometimes encounter significant public opposition to new sites. Provision of information to the local population is important. This is true of operational, as well as, newly developing sites.

The following techniques have been used:

- placing advertisements in local newspapers
- leaflet distribution to households
- displays in public areas e.g. libraries and local administration offices
- public meetings
- focus group discussions
- guided tours across the plant with a brief description via film or other presentation. [74, TWGComments, 2004]

Operational plants have achieved success in this area by:

- holding regular meetings with local representatives
- holding open days for public visits
- placing real time emissions data on the internet
- displaying real time emissions data on display panels at the site entrance.



## 5 BEST AVAILABLE TECHNIQUES

### General Introduction to the BAT chapter

In understanding this chapter and its contents, the attention of the reader is drawn back to the preface of this document and in particular the fifth section of the preface: “How to understand and use this document”. The techniques and associated emission and/or consumption levels, or ranges of levels, presented in this chapter have been assessed through an iterative process involving the following steps:

- identification of the key environmental issues for Waste Incineration
- examination of the techniques most relevant to address those key issues
- identification of the best environmental performance levels, on the basis of the available data in the European Union and worldwide
- examination of the conditions under which these performance levels were achieved; such as costs, cross-media effects, and the main driving forces involved in implementation of these techniques
- selection of the Best Available Techniques (BAT) and the associated emission and/or consumption levels for this sector in a general sense all according to Article 2(11) and Annex IV of the Directive.

Expert judgement by the European IPPC Bureau and the relevant Technical Working Group (TWG) has played a key role in each of these steps and in the way in which the information is presented here.

On the basis of this assessment, techniques, and as far as possible emission and consumption levels associated with the use of BAT, are presented in this chapter that are considered to be appropriate to the sector as a whole and in many cases reflect current performance of some installations within the sector. Where emission or consumption levels “associated with best available techniques” are presented, this is to be understood as meaning that those levels represent the environmental performance that could be anticipated as a result of the application, in this sector, of the techniques described, bearing in mind the balance of costs and advantages inherent within the definition of BAT. However, they are neither emission nor consumption limit values and should not be understood as such. In some cases it may be technically possible to achieve better emission or consumption levels but due to the costs involved or cross-media considerations, they are not considered to be appropriate as BAT for the sector as a whole. However, such levels may be considered to be justified in more specific cases where there are special driving forces.

The emission and consumption levels associated with the use of BAT have to be seen together with any specified reference conditions (e.g. averaging periods).

The concept of “levels associated with BAT” described above is to be distinguished from the term “achievable level” used elsewhere in this document. Where a level is described as “achievable” using a particular technique or combination of techniques, this should be understood to mean that the level may be expected to be achieved over a substantial period of time in a well maintained and operated installation or process using those techniques, although the particular circumstances (e.g. technical conditions, costs, cross-media impacts) that gave rise to the achieved level may mean that these levels are not generally considered to be BAT.

Where available, data concerning costs have been given together with the description of the techniques presented in the previous chapters. These give a rough indication about the magnitude of costs involved. However, the actual cost of applying a technique will depend strongly on the specific situation regarding, for example, taxes, fees, and the technical characteristics of the installation concerned. It is not possible to evaluate such site-specific factors fully in this document. In the absence of data concerning costs, conclusions on economic viability of techniques are drawn from observations on existing installations.

It is intended that the general BAT in this chapter are a reference point against which to judge the current performance of an existing installation or to judge a proposal for a new installation. In this way they will assist in the determination of appropriate "BAT-based" conditions for the installation or in the establishment of general binding rules under Article 9(8). It is foreseen that new installations can be designed to perform at or even better than the general BAT levels presented here, and that existing installations could move towards the general BAT levels or do better, subject to the technical and economic applicability of the techniques in each case.

While the BAT reference documents do not set legally binding standards, they are meant to give information for the guidance of industry, Member States and the public on achievable emission and consumption levels when using specified techniques. The appropriate limit values for any specific case will need to be determined taking into account the objectives of the IPPC Directive and the local considerations.

### **Additional introductory issues specifically developed for this BREF**

#### The relationship between Emission Limit Values and BAT performance:

Many European incineration plants have been the subject of specific regulations concerning their emissions to air – in some cases for many years. Regulations have included the application of emission limit values (ELVs) for some substances when released to air. The most recent European legislation is Directive 2000/76/EC, which includes a range of operational conditions and ELVs applicable to the majority of situations where waste is burned in industrial installations.

When interpreting the emission and performance levels associated with the use of BAT as reported in this chapter it is essential that the reader understands the following:

- emission and performance levels associated with the use of BAT are not the same as ELVs
- across the EU25, where this is a matter for national or local competence, ELVs are set and enforced in different ways
- the emission and performance levels given here are the operational performance levels that would normally be anticipated from the application of BAT
- compliance with the ELVs set in permits and legislation naturally results in operational levels below those ELVs
- it is important to note that, at a particular installation, lowering an emission level within the BAT range presented here may not represent the best overall solution considering costs and cross-media effects. Additionally, antagonism may exist between them i.e. lowering one may increase another. For these reasons, it is not anticipated that an installation would operate with all parameters at the lowest levels in the BAT ranges.

The ELVs that appear in the various regulations applicable to incineration have been used in equipment supply contracts as minimum performance guarantee levels for plant suppliers, to be achieved under the most adverse of operating conditions. This then leads to a situation where in actual operation, some incineration installations show operational emissions that are significantly below the ELVs (see in particular Section 3.2). It is, therefore, important to appreciate the difference between the operational performance levels that are given as BAT in this chapter, and the higher ELVs that have given rise to this level of performance.

In a hypothetical example, if the ELV for HCl is set at 10 mg/Nm<sup>3</sup>, a supplier of a particular technology may, as part of their equipment supply contract, choose to provide a performance guarantee in the region of 7 - 8 mg/ Nm<sup>3</sup>. In such a situation the plant might then typically operate at 1 - 5 mg/ Nm<sup>3</sup> with some transient variations above this.

An actual example of an ELV and reported emission results for dust at a MSWI in one MS is (data year 2001):

- ELV given in the permit was: 15 mg/Nm<sup>3</sup> (½hr average)
- range of actual measured values: 0 - 12.6 mg/Nm<sup>3</sup> (½hr average)
- monthly mean values (based on all measured ½hr average values): 0.4 - 1.8 mg/Nm<sup>3</sup>
- yearly mean value (based on all measured ½hr average values): 0.8 mg/Nm<sup>3</sup>.

It can be seen that the averaged emission values are closer to the lower level of the measured range and far below the ELV set in this example case. It should however be noted that it cannot be automatically assumed that similar relationships between ELVs and actual results will exist in other cases or other industrial sectors.

For some substances and some technologies reducing an ELV may result in difficulties in guaranteeing the lower emission level. This can then drive the adoption of a different technique for the control of that substance and require revision of the overall design of the installation.

Reducing ELVs to air on their own, without consideration of the overall integrated performance of the installation, can, whilst improving performance in one respect, give rise to an overall reduction in performance and/or significant cost impacts. This is generally supported for this sector by the results of European health impact assessment studies - which, on the basis of current evidence and modern emissions performance, suggest that the local impacts of incinerator emissions to air are either negligible or not detectable. [64, TWGComments, 2003]

The emission and performance levels associated with the use of BAT as given in this chapter are, where appropriate, given with the reference conditions under which they apply, for example the relevant monitoring and sampling periods. For emissions to air the release concentrations stated are standardised at 11 % Oxygen, dry gas, 273K and 101.3kPa.

#### Combining the BAT on waste incineration listed in this chapter:

When considering the BAT described here for waste incineration, it is important to consider that the optimal solution for a particular incineration installation as a whole, varies according to local conditions. A checklist for the best local solution is not what the BAT listed here provides, as this would require the consideration of local conditions to a degree that cannot be carried out in a document dealing with BAT in general. Hence, the simple combination of the individual elements described here as BAT in general, without consideration of local conditions is not likely to give the optimised local solution in relation to the environment as a whole. [74, TWGComments, 2004]

#### The relationship between BAT and site selection for waste incineration installations:

This document does not itself deal with criteria for the selection of suitable sites for waste incineration plants, but it is the case that for some of the BAT to be fulfilled, special site conditions are required. However, the choice of a site itself will typically require consideration of many other important criteria e.g. site availability, waste transport to the installation etc.

For example, in a particular local circumstance it may only be possible to build either:

- a) an installation with very high rates of energy recovery in a location that then requires long waste transport distances, or
- b) one with reduced energy recovery that then reduces the waste transport

Such advantages and disadvantages themselves are often considered together in a balanced way when the location is being selected. The result may then be that, owing to the location selected, some of the BAT included here are simply unavailable at the installation level.

Understanding the application of the BAT described in this chapter:

This BREF deals with wastes of different types (e.g. HW, MSW, sludge) which exhibit a very wide range of characteristics between and even within the different classes e.g. particulate size, calorific value, water and ash content, type and concentration of pollutants. Therefore when considering the BAT presented in this chapter the applicability of the techniques described in Chapter 4 must always be checked for a specific plant. Article 9 (4) of the Directive takes this into account saying that permit conditions shall be based on BAT “*without prescribing the use of any technique or specific technology, but taking into account the technical characteristics of the installation concerned, its geographical location and the local environmental conditions.*”

The BAT that are listed in this chapter include generic BAT (see 5.1) and specific BAT (see 5.2, 5.3, 5.4, 5.5 and 5.6) for certain waste types. The generic BAT are those that are considered to be generally applicable to all types of waste incineration installations. The waste type specific BAT are those that are considered to be generally BAT for installations dealing mainly or wholly with certain types of waste (i.e. dedicated installations). At installations that are receiving more than one waste type a combination of the specific BAT may represent BAT, however no assessment of when and to what degree they should be applied is made here and a local judgement will be required.

Overall BAT for a specific case	
Generic BAT plus	Specific BAT for waste type
as described in 5.1	Municipal waste incineration – section 5.2
	Pretreated or selected municipal waste (including municipal refuse derived fuels) – section 5.3
	Hazardous waste incineration) – section 5.4
	Sewage sludge incineration) – section 5.5
	Clinical waste incineration) – section 5.6

**Table 5.1: How to combine the BAT described for a specific case**

Because it is not possible to be exhaustive and because of the dynamic nature of industry, and the momentary nature of this document, it is possible that there may be additional techniques not described in this chapter but which meet or exceed the BAT criteria established here.

## 5.1 Generic BAT for all waste incineration

The generic BAT in this section are additional to those listed later in this chapter for individual sub-sectors of the incineration industry.

It is considered that in general for each waste incineration installation, the combination of the BAT listed here (section 5.1), together with the waste type specific BAT listed in sections 5.2 to 5.6 represent a starting point for the process of determining appropriate local techniques and conditions. The practical aim is therefore the local optimisation in the circumstances of the installation, taking account of this BAT guidance, and other local factors.

For waste incineration, the local factors to be taken into account may, amongst others, generally include:

- local environmental drivers e.g. background environmental quality may influence the required local performance in respect of releases from the installation, or availability of certain resources
- the particular nature of the waste(s) that arise locally and the impact of the waste management infrastructure upon the type and nature of waste arriving at the installation
- the cost and technical possibility of implementing a particular technique in relation to its potential advantages – this is of particular relevance when considering the performance of existing installations
- the availability, degree of utilisation and price of options for the recovery/disposal of residues produced at the installation
- the availability and price received for recovered energy
- local economic/market/political factors that may influence the tolerability of the higher gate fees that may accompany the addition of certain technological options.

Therefore, in combination with the additional waste stream specific BAT listed in later sections of this chapter, in order to provide for levels of performance that are generally compatible with BAT, in general BAT for waste incineration is considered to be:

1. the selection of an installation design that is suited to the characteristics of the waste received, as described in 4.1.1 and 4.2.1 and 4.2.3
2. the maintenance of the site in a generally tidy and clean state, as described in 4.1.2
3. to maintain all equipment in good working order, and to carry out maintenance inspections and preventative maintenance in order to achieve this
4. to establish and maintain quality controls over the waste input, according to the types of waste that may be received at the installation, as described in:
  - 4.1.3.1 Establishing installation input limitations and identifying key risks, and
  - 4.1.3.2 Communication with waste suppliers to improve incoming waste quality control, and
  - 4.1.3.3 Controlling waste feed quality on the incinerator site, and
  - 4.1.3.4 Checking, sampling and testing incoming wastes, and
  - 4.1.3.5 Detectors for radioactive materials.
5. the storage of wastes according to a risk assessment of their properties, such that the risk of potentially polluting released is minimised. In general it is BAT to store waste in areas that have sealed and resistant surfaces, with controlled and separated drainage as described in 4.1.4.1.
6. to use techniques and procedures to restrict and manage waste storage times, as described in 4.1.4.2, in order to generally reduce the risk of releases from storage of waste/container deterioration, and of processing difficulties that may arise. In general it is BAT to:
  - prevent the volumes of wastes stored from becoming too large for the storage provided
  - in so far as is practicable, control and manage deliveries by communication with waste suppliers, etc.
7. to minimise the release of odour (and other potential fugitive releases) from bulk waste storage areas (including tanks and bunkers, but excluding small volume wastes stored in containers) and waste pretreatment areas by passing the extracted atmosphere to the incinerator for combustion (see 4.1.4.4).

In addition it is also considered to be BAT to make provision for the control of odour (and other potential fugitive releases) when the incinerator is not available (e.g. during maintenance) by:

- a. avoiding waste storage overload, and/or
  - b. extracting the relevant atmosphere via an alternative odour control system
8. the segregation of the storage of wastes according to a risk assessment of their chemical and physical characteristics to allow safe storage and processing, as described in 4.1.4.5
  9. the clear labelling of wastes that are stored in containers such that they may continually be identified, as described in 4.1.4.6.
  10. the development of a plan for the prevention, detection and control (described in 4.1.4.7) of fire hazards at the installation, in particular for:
    - waste storage and pretreatment areas
    - furnace loading areas
    - electrical control systems
    - bag house filters and static bed filters.

It is generally BAT for the plan implemented to include the use of:

- a. automatic fire detection and warning systems, and
  - b. the use of either a manual or automatic fire intervention and control system as required according to the risk assessment carried out.
11. the mixing (e.g. using bunker crane mixing) or further pretreatment (e.g. the blending of some liquid and pasty wastes, or the shredding of some solid wastes) of heterogeneous wastes to the degree required to meet the design specifications of the receiving installation (4.1.5.1). When considering the degree of use of mixing/pretreatment it is of particular importance to consider the cross-media effects (e.g. energy consumption, noise, odour or other releases) of the more extensive pretreatments (e.g. shredding). Pretreatment is most likely to be a requirement where the installation has been designed for a narrow specification, homogeneous waste.
  12. the use of the techniques described in 4.1.5.5 or 4.6.4 to, as far as practicably and economically viable, remove ferrous and non-ferrous recyclable metals for their recovery either:
    - a. after incineration from the bottom ash residues, or
    - b. where the waste is shredded (e.g. when used for certain combustion systems) from the shredded wastes before the incineration stage.
  13. the provision of operators with a means to visually monitor, directly or using television screens or similar, waste storage and loading areas, as described in 4.1.6.1
  14. the minimisation of the uncontrolled ingress of air into the combustion chamber via waste loading or other routes, as described in 4.1.6.4
  15. the use of flow modelling which may assist in providing information for new plants or existing plants where concerns exist regarding the combustion or FGT performance (such as described in 4.2.2), and to provide information in order to:
    - a. optimise furnace and boiler geometry so as to improve combustion performance, and
    - b. optimise combustion air injection so as to improve combustion performance, and
    - c. where SNCR or SCR is used, to optimise reagent injection points so as to improve the efficiency of NO<sub>x</sub> abatement whilst minimising the generation of



nitrous oxide, ammonia and the consumption of reagent (see general sections on SCR and SNCR at 4.4.4.1 and 4.4.4.2).

16. in order to reduce overall emissions, to adopt operational regimes and implement procedures (e.g. continuous rather than batch operation, preventative maintenance systems) in order to minimise as far as practicable planned and unplanned shutdown and start-up operations, as described in 4.2.5
17. the identification of a combustion control philosophy, and the use of key combustion criteria and a combustion control system to monitor and maintain these criteria within appropriate boundary conditions, in order to maintain effective combustion performance, as described in 4.2.6. Techniques to consider for combustion control may include the use of infrared cameras (see 4.2.7), or others such as ultra-sound measurement or differential temperature control
18. the optimisation and control of combustion conditions by a combination of:
  - a. the control of air (oxygen) supply, distribution and temperature, including gas and oxidant mixing
  - b. the control of combustion temperature level and distribution, and
  - c. the control of raw gas residence time.

Appropriate techniques for securing these objectives are described in:

- 4.2.8 Optimisation of air supply stoichiometry
  - 4.2.9 Primary air supply optimisation and distribution
  - 4.2.11 Secondary air injection, optimisation and distribution
  - 4.2.19 Optimisation of time, temperature, turbulence of gases in the combustion zone, and oxygen concentrations
  - 4.2.4 Design to increase turbulence in the secondary combustion chamber
19. in general it is BAT to use those operating conditions (i.e. temperatures, residence times and turbulence) as specified in Article 6 of Directive 2000/76. The use of operating conditions in excess of those that are required for efficient destruction of the waste should generally be avoided. The use of other operating conditions may also be BAT – if they provide for a similar or better level of overall environmental performance. For example, where the use of operational temperatures of below the 1100 °C (as specified for certain hazardous waste in 2000/76/EC) have been demonstrated to provide for a similar or better level of overall environmental performance, the use of such lower temperatures is considered to be BAT.
  20. the preheating of primary combustion air for low calorific value wastes, by using heat recovered within the installation, in conditions where this may lead to improved combustion performance (e.g. where low LCV/high moisture wastes are burned) as described in 4.2.10. In general this technique is not applicable to hazardous waste incinerators.
  21. the use of auxiliary burner(s) for start-up and shut-down and for maintaining the required operational combustion temperatures (according to the waste concerned) at all times when unburned waste is in the combustion chamber, as described in 4.2.20
  22. the use of a combination of heat removal close to the furnace (e.g. the use of water walls in grate furnaces and/or secondary combustion chambers) and furnace insulation (e.g. refractory areas or other lined furnace walls) that, according to the NCV and corrosiveness of the waste incinerated, provides for:
    - a. adequate heat retention in the furnace (low NCV wastes require higher retention of heat in the furnace)
    - b. additional heat to be transferred for energy recovery (higher NCV wastes may allow/require heat removal from earlier furnace stages)

The conditions under which the various techniques may be applicable are described in 4.2.22 and 4.3.12

23. the use of furnace (including secondary combustion chambers etc.) dimensions that are large enough to provide for an effective combination of gas residence time and temperature such that combustion reactions may approach completion and result in low and stable CO and VOC emissions, as described in 4.2.23
24. When gasification or pyrolysis is used, in order to avoid the generation of waste, it is BAT to:
  - a. combine the gasification or pyrolysis stage with a subsequent combustion stage with energy recovery and flue-gas treatment that provides for operational emission levels to air within the BAT associated emission ranges specified in this BAT chapter, and/ or
  - b. recover or supply for use of the substances (solid, liquid or gaseous) that are not combusted
25. in order to avoid operational problems that may be caused by higher temperature sticky fly ashes, to use a boiler design that allows gas temperatures to reduce sufficiently before the convective heat exchange bundles (e.g. the provision of sufficient empty passes within the furnace/boiler and/or water walls or other techniques that aid cooling), as described in 4.2.23 and 4.3.11. The actual temperature above which fouling is significant is waste type and boiler steam parameter dependent. In general for MSW it is usually 600 – 750 °C, lower for HW and higher for SS. Radiative heat exchangers, such as platten type super heaters, may be used at higher flue-gas temperatures than other designs (see 4.3.14).
26. the overall optimisation of installation energy efficiency and energy recovery, taking into account the techno-economic feasibility (with particular reference to the high corrosivity of the flue-gases that results from the incineration of many wastes e.g. chlorinated wastes), and the availability of users for the energy so recovered, as described in 4.3.1, and in general:
  - a. to reduce energy losses with flue-gases, using a combination of the techniques described in 4.3.2 and 4.3.5
  - b. the use of a boiler to transfer the flue-gas energy for the production of electricity and/or supply of steam/heat with a thermal conversion efficiency of:
    - i. for mixed municipal waste at least 80 % (ref. Table 3.46)
    - ii. for pretreated municipal wastes (or similar waste) treated in fluidised bed furnaces, 80 to 90 %
    - iii. for hazardous wastes giving rise to increased boiler corrosion risks (typically from chlorine/sulphur content), above 60 to 70 %
    - iv. for other wastes conversion efficiency should generally be increased in the range 60 to 90 %
  - c. for gasification and pyrolysis processes that are combined with a subsequent combustion stage, the use of a boiler with a thermal conversion efficiency of at least 80 %, or the use of a gas engine or other electrical generation technology
27. to secure where practicable, long-term base-load heat/steam supply contracts to large heat/steam users (see 4.3.1) so that a more regular demand for the recovered energy exists and therefore a larger proportion of the energy value of the incinerated waste may be used
28. the location of new installations so that the use of the heat and/or steam generated in the boiler can be maximised through any combination of:
  - a. electricity generation with heat or steam supply for use (i.e. use CHP)
  - b. the supply of heat or steam for use in district heating distribution networks
  - c. the supply of process steam for various, mainly industrial, uses (see examples in 4.3.18)

- d. the supply of heat or steam for use as the driving force for cooling/air conditioning systems

Selection of a location for a new installation is a complex process involving many local factors (e.g. waste transport, availability of energy users, etc) which are addressed by IPPC Directive Article 9(4). The generation of electricity only may provide the most energy efficient option for the recovery of the energy from the waste in specific cases where local factors prevent heat/steam recovery.

29. in cases where electricity is generated, the optimisation of steam parameters (subject to user requirements for any heat and steam produced), including consideration of (see 4.3.8):
  - a. the use of higher steam parameters to increase electrical generation, and
  - b. the protection of boiler materials using suitably resistant materials (e.g. claddings or special boiler tube materials)

The optimal parameters for an individual installation are highly dependent upon the corrosivity of the flue-gases and hence upon the waste composition.

30. the selection of a turbine suited to:
  - a. the electricity and heat supply regime, as described in 4.3.7
  - b. high electrical efficiency
31. at new or upgrading installations, where electricity generation is the priority over heat supply, the minimisation of condenser pressure, as described in 4.3.9
32. the general minimisation of overall installation energy demand, including consideration of the following (see 4.3.6):
  - a. for the performance level required, the selection of techniques with lower overall energy demand in preference to those with higher energy demand
  - b. wherever possible, ordering flue-gas treatment systems in such a way that flue-gas reheating is avoided (i.e. those with the highest operational temperature before those with lower operational temperatures)
  - c. where SCR is used;
    - i. to use heat exchangers to heat the SCR inlet flue-gas with the flue-gas energy at the SCR outlet
    - ii. to generally select the SCR system that, for the performance level required (including availability/fouling and reduction efficiency), has the lower operating temperature
  - d. where flue-gas reheating is necessary, the use of heat exchange systems to minimise flue-gas reheating energy demand
  - e. avoiding the use of primary fuels by using self produced energy in preference to imported sources
33. where cooling systems are required, the selection of the steam condenser cooling system technical option that is best suited to the local environmental conditions, taking particular account of potential cross-media impacts, as described in 4.3.10
34. the use of a combination of on-line and off-line boiler cleaning techniques to reduce dust residence and accumulation in the boiler, as described in 4.3.19
35. the use of an overall flue-gas treatment (FGT) system that, when combined with the installation as a whole, generally provides for the operational emission levels listed in Table 5.2 for releases to air associated with the use of BAT.

Substance(s)	Table 5.2: Operational emission level ranges associated with the use of BAT (see notes below) for releases to air (in mg/Nm <sup>3</sup> or as stated)			
	Non-continuous samples	½ hour average	24 hour average	Comments
<b>Total dust</b>		1 – 20 (see split view 2)	1 – 5	In general the use of fabric filters give the lower levels within these emission ranges. Effective maintenance of dust control systems is very important. Energy use can increase as lower emission averages are sought. Controlling dust levels generally reduces metal emissions too.
<b>Hydrogen chloride (HCl)</b>		1 – 50	1 – 8	Waste control, blending and mixing can reduce fluctuations in raw gas concentrations that can lead to elevated short-term emissions. Wet FGT systems generally have the highest absorption capacity and deliver the lowest emission levels for these substances, but are generally more expensive. See Table 5.3 for consideration of criteria for selection between the main FGT systems, including cross-media impacts.
<b>Hydrogen fluoride (HF)</b>		<2 (see split view 2)	<1	
<b>Sulphur dioxide (SO<sub>2</sub>)</b>		1 – 150 (see split view 2)	1 – 40 (see split view 2)	Waste and combustion control techniques coupled with SCR generally result in operation within these emission ranges. The use of SCR imposes an additional energy demand and costs. In general at larger installations the use of SCR results in less significant additional cost per tonne of waste treated. High N waste may result in increased raw gas NO <sub>x</sub> concentrations.
<b>Nitrogen monoxide (NO) and nitrogen dioxide (NO<sub>2</sub>), expressed as nitrogen dioxide for installations using SCR</b>		40 – 300 (see split view 2)	40 – 100 (see split view 2)	
<b>Nitrogen monoxide (NO) and nitrogen dioxide (NO<sub>2</sub>) expressed as nitrogen dioxide for installations not using SCR</b>		30 – 350	120 – 180	Waste and combustion control techniques with SNCR generally result in operation within these emission ranges. 24 hour averages below this range generally require SCR although levels below 70mg/Nm <sup>3</sup> have been achieved using SNCR e.g. where raw NO <sub>x</sub> is low and/or at high reagent dose rates) Where high SNCR reagent dosing rates are used, the resulting NH <sub>3</sub> slip can be controlled using wet FGT with appropriate measures to deal with the resultant ammoniacal waste water. High N waste may result in increased raw gas NO <sub>x</sub> concentrations. (See also note 8 below in respect of small installations).
<b>Gaseous and vaporous organic substances, expressed as TOC</b>		1 – 20	1 – 10	Techniques that improve combustion conditions reduce emissions of these substances. Emission concentrations are generally not influenced greatly by FGT. CO levels may be higher during start-up and shut down, and with new boilers that have not yet established their normal operational fouling level
<b>Carbon monoxide (CO)</b>		5 – 100	5 – 30	
<b>Mercury and its compounds (as Hg)</b>	<0.05 (see split view 2)	0.001 – 0.03	0.001 – 0.02	Adsorption using carbon based reagents is generally required to achieve these emission levels with many wastes - as metallic Hg is more difficult to control than ionic Hg. The precise abatement performance and technique required will depend on the levels and distribution of Hg in the waste. Some waste streams have very highly variable Hg concentrations – waste pretreatment may be required in such cases to prevent peak overloading of FGC system capacity. Continuous monitoring of Hg is <u>not</u> required by Directive 2000/76/EC but has been carried out in some MSs
<b>Total cadmium and thallium (and their compounds expressed as the metals)</b>	0.005 - 0.05 (see split view 2)			See comments for Hg. The lower volatility of these metals than Hg means that dust and other metal control methods are more effective at controlling these substances than Hg.
<b>Σ other metals</b>	0.005 - 0.5			Techniques that control dust levels generally also control these metals
<b>Dioxins and furans (ng TEQ/Nm<sup>3</sup>)</b>	0.01 – 0.1 (see split view 2)			Combustion techniques destroy PCDD/F in the waste. Specific design and temperature controls reduce <i>de-novo</i> synthesis. In addition to such measures, abatement techniques using carbon based absorbents reduce final emissions to within this emission range. Increased dosing rates for carbon absorbent may give emissions to air as low as 0.001 but result in increased consumption and residues.

Substances not included in Directive 2000/76/EC on waste incineration:				
Ammonia (NH <sub>3</sub> )	<10	1 – 10	<10 (see split view 1)	Effective control of NO <sub>x</sub> abatement systems, including reagent dosing contributes to reducing NH <sub>3</sub> emissions. Wet scrubbers absorb NH <sub>3</sub> and transfer it to the waste water stream.
Benz(a)pyrene	For these substances there was insufficient data to draw a firm BAT conclusion on emission levels. However, the data provided in Chapter 3 indicates that their emission levels are generally low. PCBs, PAHs and benz(a)pyrene can be controlled using the techniques applied for PCDD/F. N <sub>2</sub> O levels are determined by combustion technique and optimisation, and SNCR optimisation where urea is used.			Techniques that control PCDD/F also control Benz(a)pyrene, PCBs and PAHs
PCBs				
PAHs				
Nitrous oxide (N <sub>2</sub> O)				Effective oxidative combustion and control of NO <sub>x</sub> abatement systems contribute to reducing N <sub>2</sub> O emissions. The higher levels may be seen with fluidised beds operated at lower temperatures e.g. below ~900 °C
<b>NOTES:</b>				
1. The ranges given in this table are the levels of operational performance that may generally be expected as a result of the application of BAT – they are not legally binding emission limit values (ELVs)				
2. ∑ other metals = sum of Sb, As, Pb, Cr, Co, Cu, Mn, Ni, V and their compounds expressed as the metals				
3. Non-continuous measurements are averaged over a sampling period of between 30 minutes and 8 hours. Sampling periods are generally in the order of 4 – 8 hours for such measurements.				
4. Data is standardised at 11 % Oxygen, dry gas, 273K and 101.3kP				
5. Dioxin and furans are calculated using the equivalence factors as in EC/2000/76				
6. When comparing performance against these ranges, in all cases the following should be taken into account: the confidence value associated with determinations carried out; that the relative error of such determinations increases as measured concentrations decrease towards lower detection levels				
7. The operational data supporting the above-mentioned BAT ranges were obtained according to the currently accepted codes of good monitoring practice requiring measurement equipment with instrumental scales of 0 – 3 times the WID ELV. For parameters with an emission profile of a very low baseline combined with short period peak emissions, specific attention has to be paid to the instrumental scale. For example changing the instrumental scale for the measurement of CO from 3-times the WID ELV to a 10-times higher value, has been reported in some cases, to increase the reported values of the measurement by a factor of 2 – 3. This should be taken into account when interpreting this table.				
8. One MS reported that technical difficulties have been experienced in some cases when retrofitting SNCR abatement systems to existing small MSW incineration installations, and that the cost effectiveness (i.e. NO <sub>x</sub> reduction per unit cost) of NO <sub>x</sub> abatement (e.g. SNCR) is lower at small MSWIs (i.e. those MSWIs of capacity <6 tonnes of waste/hour).				
<b>SPLIT VIEWS:</b>				
1 <b>BAT 35</b> : Based upon their knowledge of the performance of existing installations a few Member States and the Environmental NGO expressed the split view that the 24 hour NH <sub>3</sub> emission range associated with the use of BAT should be <5 mg/Nm <sup>3</sup> (in the place of <10 mg/ Nm <sup>3</sup> )				
2 <b>BAT 35</b> : One Member State and the Environmental NGO expressed split views regarding the BAT ranges in table 5.2 (air). These split views were based upon their knowledge of the performance of a number of existing installations, and their interpretation of data provided by the TWG and also of that included in this BREF document (e.g. in Chapter 3). The final outcome of the TWG meeting was the ranges shown in Table 5.2, but with the following split views recorded: total dust 1/2hr average 1 - 10 mg/Nm <sup>3</sup> ; NO <sub>x</sub> (as NO <sub>2</sub> ) using SCR 1/2hr average 30 - 200 and 24hr average 30 - 100 mg/Nm <sup>3</sup> ; Hg and its compounds (as Hg) non-continuous 0.001 - 0.03 mg/Nm <sup>3</sup> ; Total Cd + Tl non-continuous 0.005 - 0.03mg/Nm <sup>3</sup> ; Dioxins and furans non-continuous 0.01 - 0.05 ng TEQ/Nm <sup>3</sup> . Based on the same rationale, the Environmental NGO also registered the following split views: HF 1/2hr average <1 mg/Nm <sup>3</sup> ; SO <sub>2</sub> 1/2hr average 1 – 50 mg/Nm <sup>3</sup> and 24hr average 1 – 25 mg/Nm <sup>3</sup> .				

**Table 5.2 Operational emission level ranges associated with the use of BAT for releases to air from waste incinerators**

36. when selecting the overall FGT system, to take into account:
  - a. the general factors described in 4.4.1.1 and 4.4.1.3
  - b. the potential impacts on energy consumption of the installation, as described in section 4.4.1.2
  - c. the additional overall-system compatibility issues that may arise when retrofitting existing installations (see 4.4.1.4)
  
37. when selecting between wet/ semi-wet/ and dry FGT systems, to take into account the (non-exhaustive) general selection criteria given as an example in Table 5.3:

Criteria	Wet FGT (W)	Semi-wet FGT (SW)	Dry lime FGT (DL)	Dry sodium bicarbonate FGT (DS)	Comments
Air emissions performance	+	0	-	0	<ul style="list-style-type: none"> <li>in respect of HCl, HF, NH<sub>3</sub> &amp; SO<sub>2</sub> wet systems generally give the lowest emission levels to air</li> <li>each of the systems are usually combined with additional dust and PCDD/F control equipment</li> <li>DL systems may reach similar emission levels as DS &amp; SW but only with increased reagent dosing rates and associated increased residue production.</li> </ul>
Residue production	+	0	-	0	<ul style="list-style-type: none"> <li>residue production per tonne waste is generally higher with DL systems and lower with W systems with greater concentration of pollutants in residues from W systems</li> <li>material recovery from residues is possible with W systems following treatment of scrubber effluent, and with DS systems</li> </ul>
Water consumption	-	0	+	+	<ul style="list-style-type: none"> <li>water consumption is generally higher with W systems</li> <li>Dry systems use little or no water</li> </ul>
Effluent production	-	+	+	+	<ul style="list-style-type: none"> <li>the effluents produced (if not evaporated) by W systems require treatment and usually discharge – where a suitable receptor for the salty treated effluent can be found (e.g. marine environments) the discharge itself may not be a significant disadvantage</li> <li>ammonia removal from effluent may be complex</li> </ul>
Energy consumption	-	0	0	0	<ul style="list-style-type: none"> <li>energy consumption higher with W systems due to pump demand – and is further increased where (as is common) combined with other FGT components e.g. for dust removal</li> </ul>
Reagent consumption	+	0	-	0	<ul style="list-style-type: none"> <li>generally lowest reagent consumption with W systems</li> <li>generally highest reagent consumption with DL – but may be reduced with reagent re-circulation</li> <li>SW, and DL &amp; DS systems can benefit from use of raw gas acid monitoring (see 4.4.3.9)</li> </ul>
Ability to cope with inlet variations of pollutant	+	0	-	0	<ul style="list-style-type: none"> <li>W systems are most capable of dealing with wide ranging and fast changing inlet concentrations of HCl, HF and SO<sub>2</sub>.</li> <li>DL systems generally offer less flexibility – although this may be improved with the use of raw gas acid monitoring (see 4.4.3.9)</li> </ul>
Plume visibility	-	0	+	+	<ul style="list-style-type: none"> <li>plume visibility is generally higher with wet systems (unless special measures used)</li> <li>dry systems generally have the lowest plume visibility</li> </ul>
Process complexity	- (highest)	0 (medium)	+	+	<ul style="list-style-type: none"> <li>W systems themselves are quite simple but other process components are required to provide an all round FGT system, including a waste water treatment plant etc.</li> </ul>
Costs - capital	Generally higher	medium	Generally lower	Generally lower	<ul style="list-style-type: none"> <li>additional cost for wet system arises from the additional costs for complementary FGT and auxiliary components – most significant at smaller plants</li> </ul>
Costs – operational	medium	Generally lower	medium	Generally lower	<ul style="list-style-type: none"> <li>there is an additional operational cost of ETP for W systems – most significant at smaller plants</li> <li>higher residue disposal costs where more residues are produced, and more reagent consumed. W systems generally produce lowest amounts of reagents and therefore may have lower reagent disposal costs.</li> <li>op. costs include consumables, disposal and maintenance costs. Op. costs depend very much on local prices for consumables and residue disposal.</li> </ul>
<p>Note: + means that the use of the technique generally offers an advantage in respect of the assessment criteria considered  0 means that the use of the technique generally offers no significant advantage or disadvantage in respect of the assessment criteria considered  - means that the use of the technique generally offers a disadvantage in respect of the assessment criteria considered</p>					

**Table 5.3: An example assessment of some IPPC relevant criteria that may be taken into account when selecting between wet/semi-wet/dry FGT options**

38. to prevent the associated increased electrical consumption, to generally (i.e. unless there is a specific local driver) avoid the use of two bag filters in one FGT line (as described in 4.4.2.2 and 4.4.2.3)
39. the reduction of FGT reagent consumption and of FGT residue production in dry, semi-wet, and intermediate FGT systems by a suitable combination of:
- adjustment and control of the quantity of reagent(s) injected in order to meet the requirements for the treatment of the flue-gas such that the target final operational emission levels are met
  - the use of the signal generated from fast response upstream and/or downstream monitors of raw HCl and/or SO<sub>2</sub> levels (or other parameters that may prove useful for this purpose) for the optimisation of FGT reagent dosing rates, as described in 4.4.3.9
  - the re-circulation of a proportion of the FGT residues collected, as described in 4.4.3.7

The applicability and degree of use of the above techniques that represents BAT will vary according to, in particular: the waste characteristics and consequential flue-gas nature, the final emission level required, and technical experience from their practical use at the installation.

40. the use of primary (combustion related) NO<sub>x</sub> reduction measures to reduce NO<sub>x</sub> production, together with either SCR (4.4.4.1) or SNCR (4.4.4.2), according to the efficiency of flue-gas reduction required. In general SCR is considered BAT where higher NO<sub>x</sub> reduction efficiencies are required (i.e. raw flue-gas NO<sub>x</sub> levels are high) and where low final flue-gas emission concentrations of NO<sub>x</sub> are desired.

One MS reported that technical difficulties have been experienced in some cases when retrofitting SNCR abatement systems to existing small MSW incineration installations, and that the cost effectiveness (i.e. NO<sub>x</sub> reduction per unit cost) of NO<sub>x</sub> abatement (e.g. SNCR) is lower at small MSWIs (i.e. those MSWIs of capacity <6 tonnes of waste/hour).

41. for the reduction of overall PCDD/F emissions to all environmental media, the use of:
- techniques for improving knowledge of and control of the waste, including in particular its combustion characteristics, using a suitable selection of techniques described in 4.1, and
  - primary (combustion related) techniques (summarised in 4.4.5.1) to destroy PCDD/F in the waste and possible PCDD/F precursors, and
  - the use of installation designs and operational controls that avoid those conditions (see 4.4.5.2) that may give rise to PCDD/F reformation or generation, in particular to avoid the abatement of dust in the temperature range of 250 – 400 °C. Some additional reduction of de-novo synthesis is reported where the dust abatement operational temperature has been further lowered from 250 to below 200 °C, and
  - the use of a suitable combination of one or more of the following additional PCDD/F abatement measures:
    - adsorption by the injection of activated carbon or other reagents at a suitable reagent dose rate, with bag filtration, as described in 4.4.5.6, or
    - adsorption using fixed beds with a suitable adsorbent replenishment rate, as described in 4.4.5.7, or
    - multi layer SCR, adequately sized to provide for PCDD/F control, as described in 4.4.5.3, or
    - the use of catalytic bag filters (but only where other provision is made for effective metallic and elemental Hg control), as described in 4.4.5.4

42. where wet scrubbers are used, to carry out an assessment of PCDD/F build up (memory effects) in the scrubber and adopt suitable measures to deal with this build up and prevent scrubber breakthrough releases. Particular consideration should be given to the possibility of memory effects during shut-down and start-up periods.



43. if re-burn of FGT residues is applied, then suitable measures should be taken to avoid the re-circulation and accumulation of Hg in the installation
44. for the control of Hg emissions where wet scrubbers are applied as the only or main effective means of total Hg emission control:
  - a. the use of a low pH first stage with the addition of specific reagents for ionic Hg removal (as described in 4.4.6.1, 4.4.6.6 and 4.4.6.5), in combination with the following additional measures for the abatement of metallic (elemental) Hg, as required in order to reduce final air emissions to within the BAT emission ranges given for total Hg
  - b. activated carbon injection, as described in 4.4.6.2, or
  - c. activated carbon or coke filters, as described in 4.4.6.7
45. for the control of Hg emissions where semi-wet and dry FGT systems are applied, the use of activated carbon or other effective adsorptive reagents for the adsorption of PCDD/F and Hg, as described in 4.4.6.2, with the reagent dose rate controlled so that final air emissions are within the BAT emission ranges given for Hg
46. the general optimisation of the re-circulation and re-use of waste water arising on the site within the installation, as described in 4.5.8, including for example, if of sufficient quality, the use of boiler drain water as a water supply for the wet scrubber in order to reduce scrubber water consumption by replacing scrubber feed-water (see 4.5.6)
47. the use of separate systems for the drainage, treatment and discharge of rainwater that falls on the site, including roof water, so that it does not mix with potential or actual contaminated waste water streams, as described in 4.5.9. Some such waste water streams may require only little or no treatment prior to their discharge, depending on contamination risk and local discharge factors
48. where wet flue-gas treatment is used:
  - a. the use of on-site physico/chemical treatment of the scrubber effluents prior to their discharge from the site, as described in 4.5.11, and thereby to achieve, at the point of discharge from the effluent treatment plant (ETP), emission levels generally within the operational emission level ranges associated with BAT that are identified in Table 5.4
  - b. the separate treatment of the acid and alkaline waste water streams arising from the scrubber stages, as described in 4.5.13, when there are particular drivers for the additional reduction of releases to water that result, and/or where HCl and/or gypsum recovery is to be carried out
  - c. the re-circulation of wet scrubber effluent within the scrubber system, and the use of the electrical conductivity (mS/cm) of the re-circulated water as a control measure, so as to reduce scrubber water consumption by replacing scrubber feed-water, as described in 4.5.4
  - d. the provision of storage/buffering capacity for scrubber effluents, to provide for a more stable waste water treatment process, as described in 4.5.10
  - e. the use of sulphides (e.g. M-trimercaptotriazine) or other Hg binders to reduce Hg (and other heavy metals) in the final effluent, as described in 4.5.11
  - f. when SNCR is used with wet scrubbing the ammonia levels in the effluent discharge may be reduced using ammonia stripping, as described in 4.5.12, and the recovered ammonia re-circulated for use as a NO<sub>x</sub> reduction reagent

Parameter	BAT range in mg/l (unless stated)	Sampling and data information
Total suspended solids as defined by Directive 91/271/EEC	10 – 30 (95 %) 10 – 45 (100 %)	• based on spot daily or 24 hour flow proportional sample
Chemical oxygen demand	50 – 250	• based on spot daily, or 24 hour flow proportional sample
pH	pH 6.5 – pH 11	• continuous measurement
Hg and its compounds, expressed as Hg	0.001 – 0.03 (see split view 1)	<ul style="list-style-type: none"> <li>• based on monthly measurements of a flow proportional representative sample of the discharge over a period of 24 hours with one measurement per year exceeding the values given, or no more than 5 % where more than 20 samples are assessed per year</li> <li>• There have been some positive experiences with continuous monitoring of Hg</li> <li>• Total Cr levels below 0.2 mg/l provide for control of Chromium VI</li> <li>• Sb, Mn, V and Sn are not included in Directive 2000/76</li> </ul>
Cd and its compounds, expressed as Cd	0.01 – 0.05 (see split view 1&2)	
Tl and its compounds, expressed as Tl	0.01 – 0.05 (see split view 2)	
As and its compounds, expressed as As	0.01 – 0.15 (see split view 1)	
Pb and its compounds, expressed as Pb	0.01 – 0.1	
Cr and its compounds, expressed as Cr	0.01 – 0.5 (see split view 2)	
Cu and its compounds, expressed as Cu	0.01 – 0.5 (see split view 2)	
Ni and its compounds, expressed as Ni	0.01 – 0.5 (see split view 2)	
Zn and its compounds, expressed as Zn	0.01 – 1.0 (see split view 2)	
Sb and its compounds, expressed as Sb	0.005 – 0.85 (see split view 1)	
Co and its compounds, expressed as Co	0.005 – 0.05	
Mn and its compounds, expressed as Mn	0.02 – 0.2	
V and its compounds, expressed as V	0.03 – 0.5 (see split view 1)	
Sn and its compounds, expressed as Sn	0.02 – 0.5	
PCDD/F (TEQ)	0.01 – 0.1 ng TEQ/l (see split view 1&2)	• average of 6 monthly measurements of a flow proportional representative sample of the discharge over a period of 24 hours
<p><b>NOTE:</b></p> <ol style="list-style-type: none"> <li>1. Values are expressed in mass concentrations for unfiltered samples</li> <li>2. Values relate to the discharge of treated scrubber effluents without dilution</li> <li>3. BAT ranges are not the same as ELVs – see comments in introduction to Chapter 5</li> <li>4. pH is one important parameter for waste water treatment process control</li> <li>5. Confidence levels decrease as measured concentrations decrease towards lower detection levels</li> </ol> <p><b>SPLIT VIEWS:</b></p> <p><b>1 BAT 48:</b> One Member State and the Environmental NGO expressed split views regarding the BAT ranges in table 5.4 (water). These split views were based upon their knowledge of the performance of a number of existing installations, and their interpretation of data provided by the TWG and also of that included in this BREF document (e.g. in Chapter 3). The final outcome of the TWG meeting was the ranges shown in Table 5.4, but with the following split views recorded: Hg 0.001 - 0.01 mg/l; Cd 0.001 - 0.05 mg/l; As 0.003 - 0.05 mg/l; Sb 0.005 - 0.1 mg/l; V 0.01 - 0.1 mg/l; PCDD/F &lt;0.01 - 0.1 ng TEQ/l.</p> <p><b>2 BAT 48:</b> Based on the same rationale, the Environmental NGO also registered the following split views: Cd 0.001 - 0.02 mg/l; Tl 0.001 – 0.03 mg/l; Cr 0.003 – 0.02 mg/l; Cu 0.003 – 0.3 mg/l; Ni 0.003 – 0.2 mg/l; Zn 0.01 – 0.05 mg/l; PCDD/F &lt;0.01 ng TEQ/l.</p>		

**Table 5.4: BAT associated operational emission levels for discharges of waste water from effluent treatment plant receiving FGT scrubber effluent**

49. the use of a suitable combination of the techniques and principles described in 4.6.1 for improving waste burnout to the extent that is required so as to achieve a TOC value in the ash residues of below 3 wt % and typically between 1 and 2 wt %, including in particular:
- the use of a combination of furnace design (see combustion technology selection in 4.2.1), furnace operation (see 4.2.17) and waste throughput rate (see 4.2.18) that provides sufficient agitation and residence time of the waste in the furnace at sufficiently high temperatures, including any ash burn-out areas
  - the use of furnace designs that, as far as possible, physically retain the waste within the combustion chamber (e.g. narrow grate bar spacings for grates, rotary or static kilns for appreciably liquid wastes) to allow its combustion. The return of early grate riddlings to the combustion chamber for re-burn may provide a means to improve overall burn out where they contribute significantly to the deterioration of burnout (see 4.2.21)
  - the use of techniques for mixing and pretreatment of the waste, as described in BAT 11, according to the type(s) of waste received at the installation
  - the optimisation and control of combustion conditions, including air (oxygen) supply and distribution, as described in BAT 18
50. the separate management of bottom ash from fly ash and other FGT residues, so as to avoid contamination of the bottom ash and thereby improve the potential for bottom ash recovery, as described in 4.6.2. Boiler ash may exhibit similar or very different levels of contamination to that seen in bottom ash (according to local operational, design and waste specific factors) – it is therefore also BAT to assess the levels of contaminants in the boiler ash, and to assess whether separation or mixing with bottom ash is appropriate. It is BAT to assess each separate solid waste stream that arises for its potential for recovery either alone or in combination.
51. where a pre-dedusting stage (see 4.6.3 and 4.4.2.1) is in use, an assessment of the composition of the fly ash so collected should be carried out to assess whether it may be recovered, either directly or after treatment, rather than disposed of
52. the separation of remaining ferrous and non-ferrous metals from bottom ash (see 4.6.4), as far as practicably and economically viable, for their recovery
53. the treatment of bottom ash (either on or off-site), by a suitable combination of:
- dry bottom ash treatment with or without ageing, as described in 4.6.6 and 4.6.7, or
  - wet bottom ash treatment, with or without ageing, as described in 4.6.6 and 4.6.8, or
  - thermal treatment, as described in 4.6.9 (for separate treatment) and 4.6.10 (for in-process thermal treatment) or
  - screening and crushing (see 4.6.5)
- to the extent that is required to meet the specifications set for its use or at the receiving treatment or disposal site e.g. to achieve a leaching level for metals and salts that is in compliance with the local environmental conditions at the place of use.
54. the treatment of FGT residues (on or off-site) to the extent required to meet the acceptance requirements for the waste management option selected for them, including consideration of the use of the FGT residue treatment techniques described in 4.6.11
55. the implementation of noise reduction measures to meet local noise requirements (techniques are described in 4.7 and 3.6)

56. apply environmental management. A number of environmental management techniques are determined as BAT. The scope (e.g. level of detail) and nature of the EMS (e.g. standardised or non-standardised) will generally be related to the nature, scale and complexity of the installation, and the range of environmental impacts it may have.

BAT is to implement and adhere to an Environmental Management System (EMS) that incorporates, as appropriate to individual circumstances, the following features: (see Chapter 4.8)

- definition of an environmental policy for the installation by top management (commitment of the top management is regarded as a precondition for a successful application of other features of the EMS)
- planning and establishing the necessary procedures
- implementation of the procedures, paying particular attention to
  - structure and responsibility
  - training, awareness and competence
  - communication
  - employee involvement
  - documentation
  - efficient process control
  - maintenance programme
  - emergency preparedness and response
  - safeguarding compliance with environmental legislation.
- checking performance and taking corrective action, paying particular attention to
  - monitoring and measurement (see also the Reference document on Monitoring of Emissions)
  - corrective and preventive action
  - maintenance of records
  - independent (where practicable) internal auditing in order to determine whether or not the environmental management system conforms to planned arrangements and has been properly implemented and maintained.
- review by top management.

Three further features, which can complement the above stepwise, are considered as supporting measures. However, their absence is generally not inconsistent with BAT. These three additional steps are:

- having the management system and audit procedure examined and validated by an accredited certification body or an external EMS verifier
- preparation and publication (and possibly external validation) of a regular environmental statement describing all the significant environmental aspects of the installation, allowing for year-by-year comparison against environmental objectives and targets as well as with sector benchmarks as appropriate
- implementation and adherence to an internationally accepted voluntary system such as EMAS and EN ISO 14001:1996. This voluntary step could give higher credibility to the EMS. In particular EMAS, which embodies all the above-mentioned features, gives higher credibility. However, non-standardised systems can in principle be equally effective provided that they are properly designed and implemented.

Specifically for this industry sector\*, it is also important to consider the following potential features of the EMS:

- giving consideration to the environmental impact from the eventual decommissioning of the unit at the stage of designing a new plant
- giving consideration to the development of cleaner technologies
- where practicable, sectoral benchmarking on a regular basis, including energy efficiency and energy conservation activities, choice of input materials, emissions to air, discharges to water, consumption of water and generation of waste
- the development and use of procedures for the commissioning stages of new installations, generally including:
- the prior preparation of a detailed programme of works describing the commissioning programme
- an initial gap analysis of training requirements to identify pre-commissioning training needs
- health & safety needs which meet European and local requirements
- the availability of sufficient and up to date documentation regarding the installation
- emergency and accident prevention planning, generally include procedures for:
  - o serious fire
  - o major explosion
  - o sabotage/bomb
  - o site intruders
  - o major injury/death of employee/visitor/contractor
  - o traffic accident
  - o theft
  - o environmental incident
  - o power interruption
- where the plant commissioning and tuning period may give rise to emissions outside the normal regulatory controls.

All incineration installations, and in particular for those receiving hazardous wastes, personnel training programs are considered an important part of all safety management systems, especially training for:

- explosion and fire prevention
- fire extinguishing
- knowledge of chemical risks (labelling, carcinogenic substances, toxicity, corrosion, fire) and transportation

## 5.2 Specific BAT for municipal waste incineration

In addition to the generic measures given in Section 5.1, for municipal waste incineration BAT is in general considered to be:

57. the storage of all waste, (with the exception of wastes specifically prepared for storage or bulk items with low pollution potential e.g. furniture), on sealed surfaces with controlled drainage inside covered and walled buildings
58. when waste is stockpiled (typically for later incineration) it should generally be baled (see Section 4.1.4.3) or otherwise prepared for such storage so that it may be stored in such a manner that risks of odour, vermin, litter, fire and leaching are effectively controlled.
59. to pretreat the waste, in order to improve its homogeneity and therefore combustion characteristics and burn-out, by:
  - a. mixing in the bunker (see 4.1.5.1), and
  - b. the use of shredding or crushing for bulky wastes e.g. furniture (see 4.1.5.2) that are to be incinerated,to the extent that is beneficial according to the combustion system used. In general grates and rotary kilns (where used) require lower levels of pretreatment (e.g. waste mixing with bulky waste crushing) whereas fluidized bed systems require greater waste selection and pretreatment, usually including full shredding of the MSW.
60. the use of a grate design that incorporates sufficient cooling of the grate such that it permits the variation of the primary air supply for the main purpose of combustion control, rather than for the cooling of the grate itself. Air-cooled grates with well distributed air cooling flow are generally suitable for wastes of average NCV of up to approx 18 MJ/kg. Higher NCV wastes may require water (or other liquid) cooling in order to prevent the need for excessive primary air levels (i.e. levels that result in a greater air supply than the optimum for combustion control) to control grate temperature and length/position of fire on the grate (see section 4.2.14)
61. the location of new installations so that the use of CHP and/or the heat and/or steam utilisation can be maximised, so as to generally exceed an overall total energy export level of 1.9 MWh/tonne of MSW (ref. Table 3.42), based on an average NCV of 2.9 MWh/tonne (ref. Table 2.11)
62. in situations where less than 1.9 MWh/tonne of MSW (based on an average NCV of 2.9 MWh /tonne) can be exported, the greater of:
  - a. the generation of an annual average of 0.4 – 0.65 MWh electricity/tonne of MSW (based on an average NCV of 2.9 MWh/tonne (ref. Table 2.11) processed (ref. Table 3.40), with additional heat/steam supply as far as practicable in the local circumstances<sup>8</sup>, or
  - b. the generation of at least the same amount of electricity from the waste as the annual average electricity demand of the entire installation, including (where used) on-site waste pretreatment and on-site residue treatment operations (ref. Table 3.48)
63. to reduce average installation electrical demand (excluding pretreatment or residue treatment) to be generally below 0.15 MWh/tonne of MSW processed (ref. Table 3.47 and section 4.3.6) based on an average NCV of 2.9 MWh/tonne of MSW (ref. Table 2.11)

---

8) The direct use of heat/steam (export and/or self consumption) will reduce electricity generation, and therefore serving a heat demand may mean that less than 0.4 MWh el/tonne waste is generated.

### 5.3 Specific BAT for pretreated or selected municipal waste incineration

In addition to the generic measures given in Section 5.1, for pretreated or selected municipal waste (including municipal refuse derived fuels) incineration BAT is in general considered to be:

64. the storage of wastes:
  - a. in enclosed hoppers or,
  - b. on sealed surfaces with controlled drainage inside covered and walled buildings
65. when waste is stockpiled (typically for later incineration) it should generally be baled (see Section 4.1.4.3) or otherwise prepared for such storage so that it may be stored in such a manner that risks of odour, vermin, litter, fire and leaching are effectively controlled
66. at new and existing installations, the generation of the greater of:
  - a. an annual average of generally at least 0.6 – 1.0 MWh electricity/tonne of waste (based on an average NCV of 4.2 MWh/tonne), or
  - b. the annual average electricity demand of the entire installation, including (where used) on-site waste pretreatment and on-site residue treatment operations
67. the location of new installations so that:
  - a. as well as the 0.6 – 1.0 MWh/ tonne of electricity generated, the heat and/or steam can also be utilised for CHP, so that in general an additional thermal export level of 0.5 – 1.25 MWh/tonne of waste (ref. section 3.5.4.3) can be achieved (based on an average NCV of 4.2 MWh/tonne), or
  - b. where electricity is not generated, a thermal export level of 3 MWh/tonne of waste can be achieved (based on an average NCV of 4.2 MWh/tonne)
68. to reduce installation energy demand and to achieve an average installation electrical demand (excluding pretreatment or residue treatment) to generally below 0.2 MWh/tonne of waste processed (ref. Table 3.47 and section 4.3.6) based on an average NCV of 4.2 MWh/tonne of waste

## 5.4 Specific BAT for hazardous waste incineration

In addition to the generic measures given in Section 5.1, for hazardous waste incineration BAT is in general considered to be:

69. in addition to the quality controls outlined in BAT4, at HWI to use specific systems and procedures, using a risk based approach according to the source of the waste, for the labelling, checking, sampling and testing of waste to be stored/treated (see 4.1.3.4). Analytical procedures should be managed by suitable qualified personnel and using appropriate procedures. In general equipment is required to test:
- the calorific value
  - the flashpoint
  - PCBs
  - Halogens (e.g. Cl, Br, F) and sulphur
  - heavy metals
  - waste compatibility and reactivity
  - radioactivity (if not already covered by BAT3 through fixed detectors at the plant entrance).

Knowledge of the process or origin of the waste is important as certain hazardous characteristics, (for example toxicity or infectiousness) are difficult to determine analytically.

70. the mixing, blending and pretreating of the waste in order to improve its homogeneity, combustion characteristics and burn-out to a suitable degree with due regard to safety considerations. Examples are the shredding of drummed and packaged hazardous wastes, described in 4.1.5.3 and 4.1.5.6. If shredding is carried out then blanketing with an inert atmosphere should be carried out.
71. the use of a feed equalisation system for solid hazardous wastes (e.g. as described in 4.1.5.4 or other similar feeding technology) in order to improve the combustion characteristics of the fed waste and to improve the stability of flue-gas composition including the improved control of short-term CO peak emissions.
72. the direct injection of liquid and gaseous hazardous wastes, where those wastes require specific reduction of exposure, releases or odour risk, as described in 4.1.6.3
73. the use of a combustion chamber design that provides for containment, agitation and transport of the waste, for example: rotary kilns - either with or without water cooling. Water cooling for rotary kilns (see 4.2.15), may be favourable in situations where:
- a. the LHV of the fed waste is higher (e.g. >15 – 17 GJ/tonne), or
  - b. higher temperatures e.g. >1100 °C are used (e.g. for ash slugging or destruction of specific wastes)
74. to reduce installation energy demand and in general, and to achieve an average installation electrical demand (excluding pretreatment or residue treatment) of generally below 0.3 – 0.5 MWh/tonne of waste processed (see 3.5.5 and 4.3.6). Smaller installations generally result in consumption levels at the upper end of this range. Weather conditions may have a significant impact on consumption owing to heating requirements etc.
75. for merchant HWI and other hazardous waste incinerators feeding wastes of highly varying composition and sources, the use of:
- a. wet FGT, as described in 4.4.3.1, is generally BAT to provide for improved control of short-term air emissions (see concluding remarks 7.4.3 ref. other systems and BAT37 regarding FGT system selection)
  - b. specific techniques for the reduction of elemental iodine and bromine emissions, as described in 4.4.7.1, where such substances exist in the waste at appreciable concentrations



## 5.5 Specific BAT for sewage sludge incineration

In addition to the generic measures given in Section 5.1, for sewage sludge incineration BAT is in general considered to be:

76. at installations that are mainly dedicated to the incineration of sewage sludge, the use of fluidised bed technology may generally be BAT because of the higher combustion efficiency and lower flue-gas volumes that generally result from such systems. There may be a risk of bed clogging with some sewage sludge compositions.
77. the drying of the sewage sludge, preferably by using heat recovered from the incineration, to the extent that additional combustion support fuels are not generally required for the normal operation of the installation (i.e. in this case, normal operation excludes start-up, shut-down and the occasional use of support fuels for maintaining combustion temperatures)

## 5.6 Specific BAT for clinical waste incineration

In addition to the generic measures given in Section 5.1, for clinical waste incineration BAT is in general considered to be:

78. the use of non-manual waste handling and loading systems
79. The receipt and storage of clinical wastes in closed containers that are suitably resistant to leaks and punctures.
80. the washing out of waste containers that are to be re-used in a specifically designed, designated washing facility, with disinfection as required, and the feeding of any accumulated solids to the waste incinerator
81. where grates are used, the use of a grate design that incorporates sufficient cooling of the grate such that it permits the variation of the primary air supply for the main purpose of combustion control, rather than for the cooling of the grate itself. Air-cooled grates with well distributed air cooling flow are generally suitable for wastes of NCV of up to approx. 18 MJ/kg. Higher NCV wastes (e.g. above approx. 18 MJ/kg) may require water (or other liquid) cooling in order to prevent the need for excessive primary air levels to control grate temperature i.e. levels that result in a greater air supply than the optimum for combustion control (see section 4.2.14)
82. the use of a combustion chamber design that provides for containment, agitation and transport of the waste, for example: rotary kilns - either with or without water cooling. Water cooling for rotary kilns, as described in 4.2.15, may be favourable in situations where:
  - a. the NCV of the fed waste is higher (e.g. >15 – 17 GJ/tonne), or
  - b. higher temperatures e.g. >1100 °C are used (e.g. for slagging or destruction of specific wastes)



## 6 EMERGING TECHNIQUES

An emerging technique is understood in this document as a novel technique that has not yet been applied in any industrial sector on a commercial basis. This chapter contains those techniques that may appear in the near future and that may be applicable to the waste incineration sector.

### 6.1 Use of steam as a spraying agent in post combustion chamber burners instead of air

#### Reference

[40, EURITS, 2003]

### 6.2 Application involving the reheating of turbine steam

#### Description

[2, infomil, 2002] p 49

Another option to increase the efficiency of electricity production is the reheating of turbine steam after its first passage through the turbine. For this application, steam temperature is limited to 400 °C, but steam pressure increases. The figure below provides a simplified process scheme for this option.

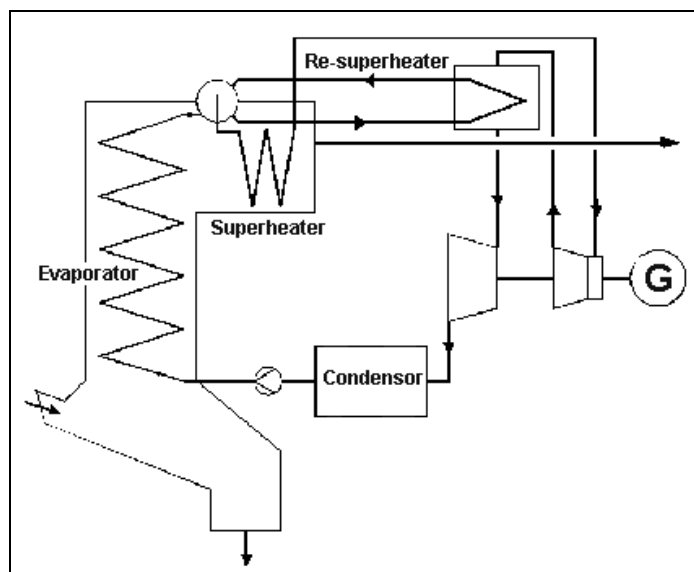

**Figure 6.1: Example of the reheating of steam**  
[2, infomil, 2002]

After the first passage through the high-pressure section of the turbine, the resulting steam is superheated again and subsequently used in the turbine's middle and low-pressure sections.

Usually after expanding in the HP turbine the steam has lower pressure (typically 20 % of pressure entering) and is reheated with flue-gas in the boiler to the same temperature. According to the simplified drawing (see Figure 6.1), the steam is heated with either boiler water or saturated steam.

#### Achieved environmental benefits

Increased electrical efficiency by approximately 2 – 3 %.

## **Cross-media effects**

### **Operational data**

This option has never been used for municipal waste incineration, although technological risks are considered to be limited.

### **Applicability**

Application may be influenced by economic feasibility, which is mainly determined by the additional investment costs and by electricity prices.

### **Economics**

### **Driving force for implementation**

### **Example plants**

### **Reference literature**

[2, infomil, 2002], p49

## **6.3 Other measures in the crude flue-gas area for reducing dioxin emissions**

[1, UBA, 2001] A reduction in dioxins can be achieved through the following measures in the crude flue-gas area, which seek to reduce dioxin formation by inhibiting the reactions or reducing the presence of dusts in the temperature range 450 – 200 °C:

- addition of inhibitors to the waste - efficiency is limited and secondary reactions require consideration
- employment of hot gas dedusters - so far only little experience from pilot tests:
  - dedusting using ceramic filters or cyclones at temperatures of approx. 800 °C
  - dedusting at temperatures above 450 °C e.g. with hot gas electrostatic filters
- reduction of deposits of airborne dust on the flue-gas path by effective cleaning of flue-gas vents, boiler, heating plates - a well proven maintenance related issue.

## **6.4 Oil scrubber for the reduction of polyhalogenated aromatics and polyaromatic hydrocarbons (PAHs) in the flue-gases from incineration plants**

Dioxins and furans have very low solubility in water and therefore they are not removed in wet scrubbers to a significant and reliable extent. Any removal which does take place is generally due to the removal of PCDD/F that is adsorbed onto particulate matter removed in the wet scrubber. At best, there is some depletion by condensation of, predominantly, of the higher molecular weight Hexa- to Octa- species from the gas phase into the relatively cold wash liquor. However, dioxins and furans (and many other organic species) are more lipophilic. A high boiling partly unsaturated oil or a oil-water emulsion of such oil therefore provide suitable scrubbing media.

The oil/emulsion and absorbed dioxin and furans, are exchanged and disposed of as soon as they reach a limit value of 0.1 mg/kg. The supply quantity is determined so that there is an exchange 3 to 4 times per year. This helps prevent excessive ageing of the oil. The contaminated liquor is incinerated in the furnace. To do this, the oil is pumped into a slop wagon (a mobile tank with safety installations) and from there directly fed into a burner in the incineration plant.

This process includes a countercurrent scrubber column as its tertiary cleaning stage with a closed oil circuit.

To minimise the number of oil-carrying plant components, a sump is used as a scrubbing media reservoir. The circulation flowrate is determined according to the packing cross-section. The oil/emulsion is heated by a heat-exchanger to approx. 15 °C – 20 °C above the flue-gas temperature to prevent water from condensing from the vapour-saturated gas.

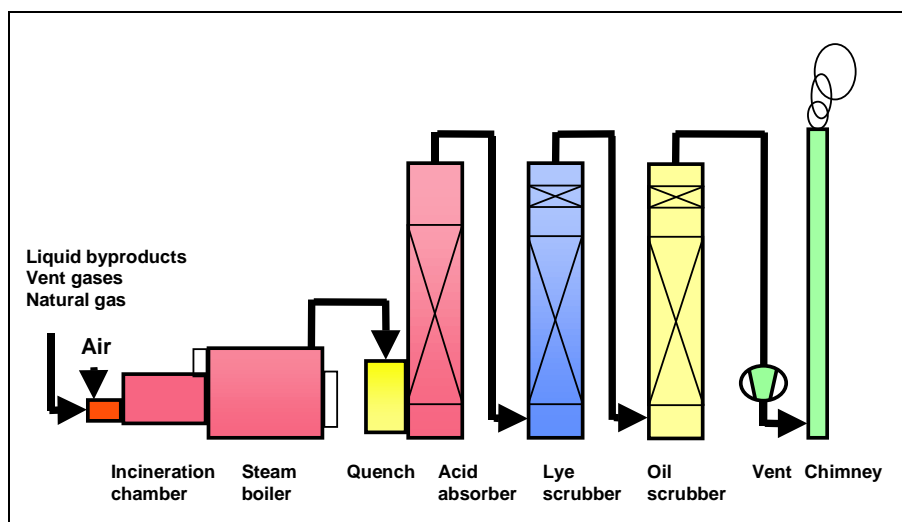
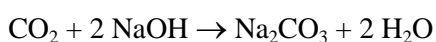

Figure 6.2: Schematic of a waste incineration plant with a downstream oil scrubber for dioxin deposition  
[1, UBA, 2001]

## 6.5 Use of CO<sub>2</sub> in flue-gases for the production of sodium carbonate

[1, UBA, 2001] If the flue-gas is brought into contact with caustic soda solution, the carbon dioxide reacts with the sodium hydroxide to form sodium carbonate. The liquid is odourless and colourless. The carbonate solution may be used as a raw material, e.g. chemical plants, paper industry.

In this process, the flue-gas quantity required for the generation of carbonate is drawn off in controlled flow at the end of flue-gas cleaning and directed into a CO<sub>2</sub> absorption column. The absorption column is made of glass-fibre reinforced plastic material and contains plastic packing material. Caustic soda solution is added to the head of the column. The caustic soda runs through the packing material and makes contact with the flue-gas rising in the reverse current. This causes carbon dioxide and sodium hydroxide to react and form sodium carbonate and water.



The flue-gas escapes from the column into the atmosphere via a mist eliminator. The mist eliminator may be cleaned using soft water (fresh water) which is supplied on demand via a flow controller.

The carbonate solution is drawn from the sump of the column and pumped to the consumer installations with a pump via a level control installation. Quantity, pH value, NaOH and carbonate concentration are recorded with adequate measuring devices. The concentration values serve to control the caustic soda quantity to the column.

There is however a significant consumption of caustic soda; and the release of CO<sub>2</sub>, generated through the production process of the soda, should also be considered.

## 6.6 Increased bed temperature, combustion control and oxygen addition in a grate incinerator

### Description

The basic concept of this process (known as the SYNCOM plus process) is the integrated sintering of ash in the waste bed of a grate based energy from the waste incinerator.

Higher bed temperatures are used to melt or sinter 50 – 80 % of the bottom ash. The unmelted fraction protects the grate from clogging.

An infrared camera signal is used to control the under fire air heating and oxygen enrichment in such a way that an appropriate range of waste bed temperatures is maintained.

Reverse acting grates are best suited to the technique because they maintain a cover of unmelted ash that protects the grate from the higher temperatures employed.

The non-sintered fraction is separated by a screening and washing process and then recirculated to the combustion process.

In addition 75 % of fly ashes (boiler ash and first stage dust removal step ash - not FGT residues from acid gas cleaning) may be re-circulated to the combustion stage. The high bed temperatures and wet mechanical treatment of the discharged granulate ash ensures that the fly ash re-circulation does not contaminate the granulate product.

### Achieved environmental benefits

A completely sintered, well burned out, low leaching residue is produced:

	Conventional WTE plants	SYNCOM	SYNCOM plus
Loss on ignition	2 %	1 %	0.1 %
Leaching of lead (mg/l)	0.2	0.05	0.01
PCDD/F content (ng TEQ/kg)	15	8	0.3

Table 6.1: Residue quality using SYNCOM system [36, Gohlke, 2002]

The system also:

- reduces overall plant dioxin discharges (<5ug I-TEQ/t of waste input)
- reduces volumes of fly ashes
- reduces flue-gas volumes by approx. 35 %.

### Cross-media effects

Consumption of oxygen.

### Operational data

#### Applicability

Applicable to grate incinerators.

#### Economics

5 – 10 % increase in overall plant investment costs.

Reductions in disposal costs for residues, with income possible from sales of granulate as an aggregate replacement.

## Driving force for implementation

### Example plants

Coberg, Germany

Under construction: Arnoldstein, Austria and others in Japan

Large scale pilot plant in Japan with Mitsubishi Heavy Industries.

### Reference literature

[36, Gohlke, 2002]

## 6.7 The PECK combination process for MSW treatment

### Description

The main features of this process are:

- use of a first stage sub-stoichiometric, gasifying grate at 950 °C
- recycling of treated fly ashes to the grate (see fly ash pretreatment description below)
- followed by a rotary kiln at 1400 °C gas temperature (1300 °C bed) with excess air ratio of 1.1 to 1.3 over stoichiometric
- the high temperature in the rotary kiln melts the mineral materials
- water quench of residues to form a glass-like phase.

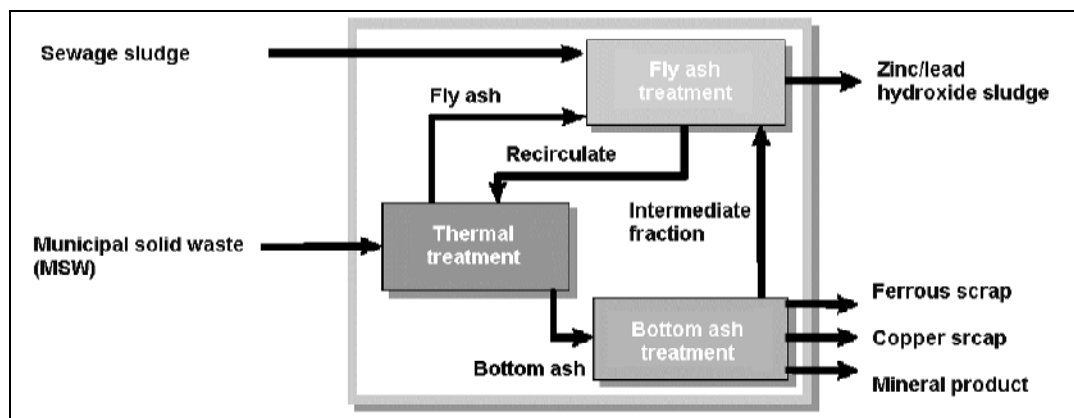
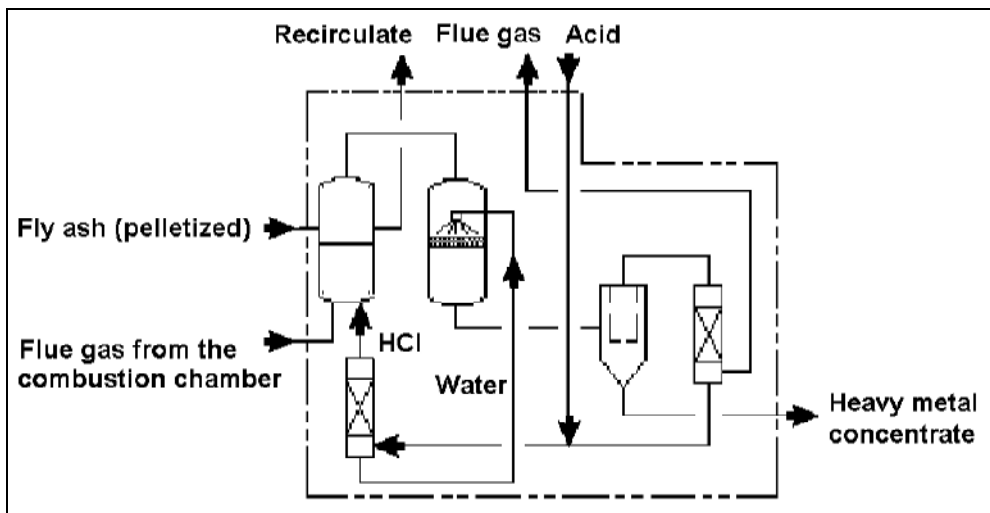

Figure 6.3: Basic components of the PECK process  
[37, Biollaz, 2001]

### Fly ash pretreatment:

Before re-circulating to the grate, fly ashes collected in the boiler and ESP are mixed with dewatered sewage sludge and fed to a pelletiser. The resulting dry pellets are treated in a fluidised bed reactor, where chlorination and evaporation of the metals take place at 900 °C. The evaporation reactor is heated by flue-gas from the post combustion chamber. This gas stream has a temperature sufficiently high to operate the reactor. Only a small portion of the total flue-gas is used, i.e. approximately 2 %.



**Figure 6.4: Fly ash treatment in the PECK process**  
[37, Biollaz, 2001]

The evaporated metals leave the fluidised bed reactor together with the flue-gas. By a partial quench the heavy metals are condensed and filtered afterwards. After this, surplus hydrochloric acid is separated from the flue-gas in the scrubber. The flue-gas is then fed back to the scrubber of the incineration plant for final cleaning and leaves the plant via the stack. Hydrochloric acid is produced in an internal loop from the washing water of the scrubber of the fly ash treatment by a distillation system. Hydrochloric acid make-up comes from the scrubber of the incineration plant. The depleted washing water is used as quenching water.

The depleted fly ash, the re-circulate, is removed from the evaporation reactor and fed back through a buffer silo to the grate. The filtered heavy metal concentrate is then transported to the zinc and lead refining industry.

#### Bottom ash treatment:

Directly after the high temperature process the bottom ash is quenched in a water bath and forms glass-like phases. After the separation of scrap metal the bottom ash is crushed in a hammer crusher. The crusher has a discharge grate of 16 mm gap and a discharge for oversize ferrous scrap. This scrap is separated manually into valuable material fractions.

Afterwards, further breakage is achieved in a ball mill which is followed by an air-classifier with a separation cut of approximately 0.5 mm. The milling and separation unit works also as a dryer which is operated with surplus heat from the thermal process. The oversize from the separator is fed to a magnetic separator and an eddy current unit, separating the ferrous metals from the non-ferrous metals, such as copper.

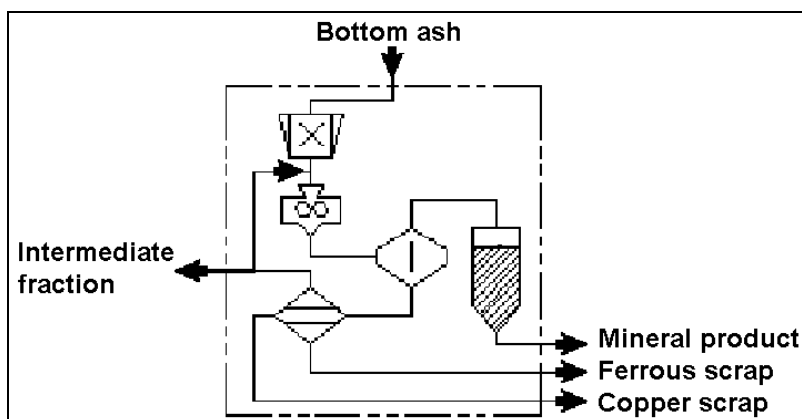

**Figure 6.5: Bottom ash treatment in the PECK process**  
[37, Biollaz, 2001]



Since the efficiency of the eddy current separation of non-ferrous metal drops sharply at particle sizes below approximately 4 mm, the metal-fines accumulate in the grinding circuit. Therefore, a small amount of the circulating load is bled off into the fly ash treatment process. This product fraction, the so-called intermediate fraction, consists of approximately 1 % of the entire bottom ash that is being processed. The air classifier undersize is recovered by cyclones and electrostatic filters and stored in silos.

### Achieved environmental benefits

The key environmental benefits over and above conventional MSWI processes are:

- production of a semi-vitrified lower leaching bottom ash residue
- vitrification is an internal process - no external energy is required
- reduced fly ash volumes
- reduction in overall dioxin outputs by destruction in the incinerator
- concentration of heavy metals into a smaller volume of solid waste (possibly recoverable)
- emissions of oxides of nitrogen to air are reduced by the air-staging process.

Partitioning of the heavy metals zinc, lead, cadmium and copper between the different output flows is shown in Figure 6.6 below and is compared to conventional incinerators. It can be seen that the process leads to reduced heavy metals in the mineral residues compared to conventional incinerators. Therefore the objective of metal depleted mineral residues is achieved. At the same time the majority of these heavy metals are concentrated into potentially recyclable metal concentrates.

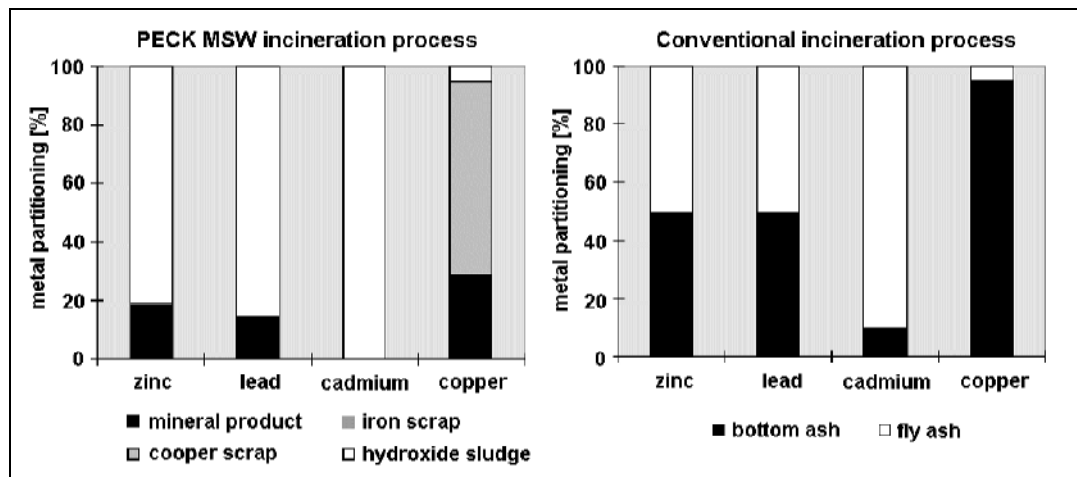

Figure 6.6: Comparison of metals partitioning between a conventional grate MSWI and the PECK process

Source [37, Biollaz, 2001]

### Cross-media effects

No adverse effects identified.

The overall electrical efficiency of the PECK process is supposed to be comparable to that of conventional MSWI including the internal electricity consumption.

### Operational data

The most relevant mass flows within the PECK process are shown in Figure 6.7 below. The flows are normalised to the input stream “MSW”, which corresponds to 100 %. The most relevant material flows produced by the MSWI are the flue-gas and mineral product.

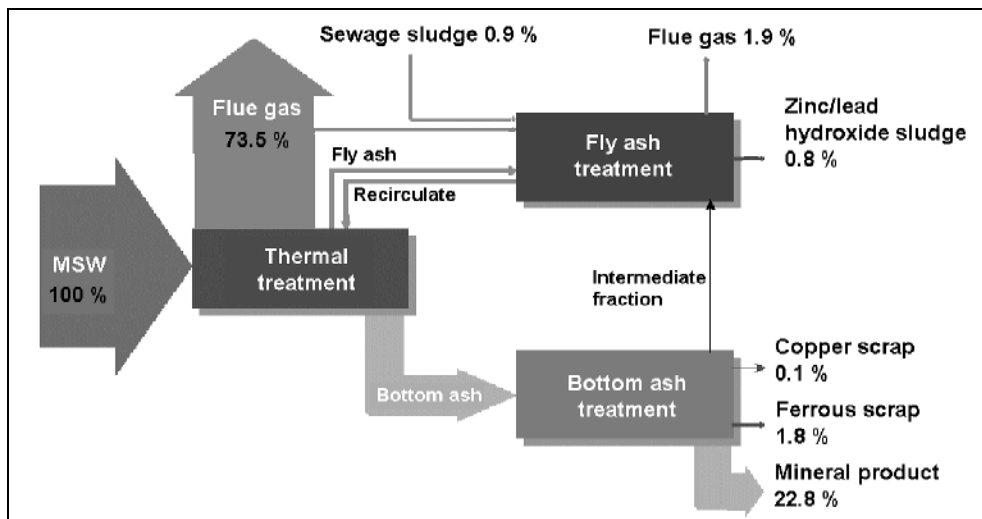

**Figure 6.7: Material flow mass balance for the PECK process**  
[37, Biollaz, 2001]

The flue-gas contains the combustion products from the organic material of MSW and water. The bottom ash, i.e. the mineral product, consists of minerals such as silica and calcium originally contained in MSW, and sewage sludge. The heavy metals are concentrated in the output flows hydroxide sludge, ferrous and copper scrap. The heavy metals flow via the mineral product and the purified flue-gas are negligible. The bed temperature of the rotary kiln (1300 °C) is low enough to prevent iron from melting and forming unwanted alloys with e.g. copper.

### Applicability

The process has been developed for municipal solid wastes but could in principle be applied to other wastes.

The process is preferably equipped with a conventional wet flue-gas purification unit. For the treatment of the fly ash, HCl is needed which can be recovered from the washing water.

### Economics

Lower operational costs for the waste treatment are obtained, as the costs for the disposal of residues are significantly reduced, while the investment and operating costs are higher than conventional MSW incinerators.

### Driving force for implementation

The main driving forces for the adoption of this technique are:

- the need to improve bottom ash quality
- the need to reduce quantities of fly ash
- the high prices for residue disposal.

### Example plants

The process is reported to have been investigated at a MSWI in Basle, Switzerland.

### Reference literature

[37, Biollaz, 2001]

## 6.8 FeSO<sub>4</sub> stabilisation of FGT residues

### Technical description

This stabilisation involves a five-step procedure, where the residues are first mixed with a FeSO<sub>4</sub> solution and then aerated with atmospheric air at liquid/solid ratio of 3 l/kg, in order to oxidise Fe(II) to Fe(III) and precipitate iron oxides. This step also includes extraction of soluble salts. The pH of the suspension is then maintained at pH 10 - 11 for about 0.5 to 1 hour to allow dissolved heavy metals to bind to the precipitated iron oxides. The fourth step of the process is dewatering of the treated residues and finally a washing step to exchange remaining water and remove remaining salts. The final stabilised product has a water content of about 50 %.

### Achieved environmental benefits

The main advantage is improved leaching properties of the final product. The leaching characteristics of treated residues are shown to be very good (Lundtorp, 2001), and it is expected that low release of heavy metals can be maintained for extended periods of time, as iron oxides are known to endure in geological time frames. The pollution potential of the treated residues is well documented and the treated residues are expected to be less prone to physical disintegration than cement stabilised products, since most of the salts are removed. The stabilised residues typically have far better leaching properties than cement solidified residues.

The process reduces the amount of residue by about 10 % per dry weight.

### Cross-media effects

No re-utilisation strategies have yet been demonstrated.

The process produces waste water with a high content of salts and relatively low concentrations of metals, because Fe(II) is present in the extraction step. The waste water can, in most cases, be discharged to a marine recipient after a simple treatment or can be de-ionised by crystallisation.

### Operational information

The process has been demonstrated on a pilot scale at a plant, treating residues in batches of about 200 kg dry weight. Parameters such as - water consumption, mixing of water and residues, Fe(II) oxidation rate, reaction time, pH and a pH controlling additive - have all been optimised. It has been demonstrated that the process is robust with respect to the properties of the residue input, although some variations in process parameters arise. Typical process data are for 1 tonne of residue: 10 - 50 kg Fe, 20 - 50 minutes aeration, 30 - 60 minutes reaction time, H<sub>2</sub>SO<sub>4</sub> or FeSO<sub>4</sub> as the pH controlling additives, optimum pH of 10 - 11, and a water consumption of 3 - 4 m<sup>3</sup>. In the current set-up, dewatering of the treated residues was achieved by using a plate and frame filter press.

### Applicability of technique

The stabilisation unit can be implemented as an integrated part of the incinerator but may also exist as a centralised treatment plant handling residues from several incinerators. The technique has been demonstrated on semi-dry FGT residues as well as fly ash alone and fly ash combined with sludge from the wet scrubbers (Bamberg product); all with good results.

### Economics

Treatment cost for a stabilisation process, called Ferrox, is estimated to about EUR 65/tonne with a plant capacity of 20000 tonne/yr; including investment costs.

### Driving force of implementation

The main reason for implementing this technology is the very good leaching properties of the treated residues, and the fact that this is expected to last in the long-term.

### References and examples

The process has only been demonstrated at pilot scale, although it has also been designed for full-scale operation. No full-scale plants have yet been established.

## 6.9 CO<sub>2</sub> stabilisation of FGT residues

### Technical description

This stabilisation resembles in many respects the FeSO<sub>4</sub> stabilisation process, however the chemical agents used here are CO<sub>2</sub> and/or H<sub>3</sub>PO<sub>4</sub>. The process involves a two-step procedure. The residues are first washed at L/S 3 l/kg, in order to extract soluble salts, and then dewatered and washed again in a plate and frame filter press at L/S 3 l/kg. The residues are then re-suspended, and CO<sub>2</sub> and/or H<sub>3</sub>PO<sub>4</sub> is added. The stabilisation reactions are allowed to occur for 1 - 1.5 hours while the pH decreases, and another hour where the pH is maintained around pH 7.

Finally, the residues are dewatered again and washed at the filter press with another 3 l/kg. The final product has a water content of about 50 %. The use of CO<sub>2</sub> and H<sub>3</sub>PO<sub>4</sub> as the stabilising agent ensures that the heavy metals are bound as carbonates or phosphates.

### Achieved environmental benefits

CO<sub>2</sub> stabilisation shows very good leaching properties similar to the Ferrox stabilisation. Metal carbonates and phosphates are known to generally have low solubility, and the leaching characteristics of CO<sub>2</sub> stabilised residues are expected to remain good for extended periods of time. The pollution potential of the treated residues is documented in detail. The physical disintegration of the treated residues in the long-term is expected to be less significant with this technique than with cement stabilisation, since most of the salts are removed. CO<sub>2</sub> stabilised residues typically have far better leaching properties than cement solidified residues.

The CO<sub>2</sub> stabilisation process reduces the amount of residue by about 15 % per dry weight.

### Cross-media effects

No reutilisation strategies have yet been demonstrated. The process produces waste water from the first dewatering step. All other process water is recycled in the process. The waste water needs to be treated for dissolved heavy metals in a standard unit, for example using pH adjustment and TMT addition.

### Operational information

The process has been demonstrated at pilot scale at a plant treating residues in batches of about 200 kg dry weight. Parameters such as water consumption, mixing of water and residues, CO<sub>2</sub> and H<sub>3</sub>PO<sub>4</sub> addition, reaction time, pH and pH controlling approach have all been optimised. It has been demonstrated that the process is robust with respect to the properties of the residue input, although some variations in process parameters arise. Depending on residue composition, either CO<sub>2</sub> or H<sub>3</sub>PO<sub>4</sub> or both have been used. It has also been demonstrated that flue-gases from the incineration plant can be used as the CO<sub>2</sub> source.

The typical process requirements for the treatment of 1 tonne of residues are: 5 - 20 kg of CO<sub>2</sub>, 0 - 40 kg H<sub>3</sub>PO<sub>4</sub> and 3 m<sup>3</sup> of water.

### Applicability of technique

The stabilisation unit can be implemented as an integrated part of the incinerator but may also exist as a centralised treatment plant handling residues from several incinerators. The technique has been demonstrated on semi-dry FGT residues as well as on fly ash alone and on fly ash combined with sludge from the wet scrubbers (Bamberg product); all with good results.

### Economics

The treatment cost for a CO<sub>2</sub> stabilisation using this process is estimated to be about EUR 80/tonne ash with a plant capacity of 200000 tonne/yr; including investment costs.

### Driving force of implementation

The main reason for implementing this technology is the very good leaching properties of the treated residues and the fact that this is expected to last in a long-term perspective.

**References and examples**

The process has only been demonstrated in pilot scale, although it has also been designed for full-scale operation. No full-scale plants have yet been implemented.

**6.10 Overview of some other emerging FGT residue treatment techniques****Treatment for supply to cement industry**

This system converts bottom ash, fly ash and neutralisation residues into a material that can be used in cement kilns.

In this process, combined neutralisation residues and fly ash (as found with dry and semi-wet FGT systems without pre-dedusting) are first washed with water to remove the highly leachable chlorides. The insoluble fraction is fed to the cement kiln together with the bottom and fly ash, substitution (in part) for limestone. The waste water is then cleaned in a WWT plant to precipitate the heavy metals. The filter cake is then fed to the cement kiln if the HM content is below acceptance levels, or may be further treated. The cleaned waste water is discharged to a municipal sewage system.

Another process (only at the pilot plant stage) also aims to supply materials to the cement industry. In this case, residue from lime based dry and semi-dry FGT systems are separated to give an inert fraction (approx. 70 wt %) that is mainly oxides for use in the cement kiln, a further fraction (approx 25 wt %) of sodium and calcium chlorides, and the remaining fraction that contains the heavy metals. The process involves a number of steps including washing, soda contact and filtering.

[64, TWGComments, 2003]

**Heavy metal evaporation process**

Fly ash is heated to around 900 °C in an atmosphere enriched with hydrochloric acid. The heavy metals are volatilised as chlorides and then condensed on a filter where they concentrate to such an extent that re-cycling may be possible. The remaining fly ash is thus cleaned and may be used for construction. When sited on an existing incineration site the flue-gases evolved may be treated in the existing FGT system, and the HCl may be drawn from a wet scrubber.

The process has not been demonstrated on a commercial scale plant.

[64, TWGComments, 2003]

**Hydro-metallurgical treatment + vitrification**

In this process hydrometallurgical treatment allows the removal of heavy metals and salts. The subsequent vitrification of the fly ash produces a slag which may be used for construction.

The process is reported to be applicable to several ash compositions and to have been demonstrated on a semi-industrial scale. The process is applied at one MSWI in France burning 120000 tonnes MSW/yr and producing 3500 tonnes/yr of treated FGT residues from this treatment process.

[TWGComments, 2003 #64, [64, TWGComments, 2003, 73, Rijpkema, 2000]

## 6.11 Application of membrane technology for use in waste water treatment plants for wet scrubber effluents

### Description

Described in Section 2.6.4.3.

### Achieved environmental benefits

Information not supplied

### Cross-media effects

Information not supplied

### Operational data

Information not supplied

### Applicability

Information not supplied

### Economics

Information not supplied

### Driving force for implementation

Information not supplied

### Example plants

Information not supplied

### Reference literature

## 6.12 Combined dry sodium bicarbonate + SCR + scrubber FGT systems

### Description

This technique consists in combining dry FGT with sodium bicarbonate with a SCR system and a scrubber.

As sodium bicarbonate presents a wide operating temperature range (140 – 300 °C) and leads to SO<sub>x</sub> emissions below 20 mg/Nm<sup>3</sup> (SO<sub>3</sub> included), it ideally combines with an SCR without reheating the FG; although FG reheat maybe needed if stack temperature is too low after wet scrubber. [74, TWGComments, 2004]

A scrubber placed after the SCR will remove the remaining HCl. As the amount of HCl removed is very low, the purge can be easily re-injected up-stream (before the injection of sodium bicarbonate) where it is completely vaporised.

The result is a FGT system without intermediate reheating steps and without liquid effluents.

### Achieved environmental benefits

Reduction of emissions to air as follows:

Substance(s)	Reduction	Achieved emission ranges				Comments
		Efficiency range (%)	½ hour average mg/Nm <sup>3</sup>	24 hour average mg/Nm <sup>3</sup>	Annual average mg/Nm <sup>3</sup>	
HCl			<5			Very stable outlet concentrations are seen
HF			<1			
SO <sub>2</sub>			<20			
NO <sub>x</sub>			<70			

**Table 6.2: Emission levels associated with the use of combined dry sodium bicarbonate and SCR FGT system**

The system combines two well known FGT technologies and has the following characteristics:

- SO<sub>2</sub> and HCl emissions at the stack are low
- the sodium bicarbonate excess is reduced because of the downstream scrubber; no gas reheating is generally needed; there are no liquid effluents to treat because the purge is re-injected upstream
- emissions are low even under fluctuating inlet concentrations.

### Cross-media effects

Cross-media effects are identified in the following table:

Criteria	Units	Range of achieved values	Comments
Energy Requirements	kWh/t waste input		FG reheat maybe needed if stack temperature is too low after wet scrubber
Reagent Consumption	kg/t waste input	9 – 14	For one tonne MSW
Reagent stoichiometry	Ratio	≤1.2	
Residue – type		Solid	FGT residues with fly ash or separated if pre-dedusting. Recycling is possible
Residue – amount	kg/t waste input	6 – 15	From one tonne MSW without filter and boiler dust
Water consumption	l/t waste input	<450	
Effluent production	l/t waste input	0	Purge re-injected upstream (<40 l/t waste input)
Plume visibility	+/-	-	

**Table 6.3: Cross-media effects associated with the use of combined dry sodium bicarbonate and SCR FGT system**

Additional FGT systems may be necessary, e.g. extra PCDD/F and Hg removal devices. [74, TWGComments, 2004]

## Operational data

Criteria	Description of factors affecting criteria	Evaluation (high/medium/low) or data	Comment
Complexity	<ul style="list-style-type: none"> <li>additional process units required</li> <li>critical operational aspects</li> <li>risk of clogging</li> </ul>	M/L	The number of process units is greater than dry systems, but smaller than other systems
Flexibility	<ul style="list-style-type: none"> <li>ability of technique to operate under range of input conditions</li> </ul>	H	Very robust – two FGT techniques makes it able to achieve emission reduction under fluctuating inlet concentrations
Skill requirements	<ul style="list-style-type: none"> <li>notable extra training or manning requirements</li> </ul>	M/L	Simple system. Bag filter requires good management

**Table 6.4: Operational data associated with the use of combined dry sodium bicarbonate and SCR FGT system**

Compared to dry systems with SCR, the scrubber and the water circuit are the only process units added.

## Applicability

The applicability of this technique is assessed in the following table:

Criteria	Evaluation/comment
Waste type	<ul style="list-style-type: none"> <li>can be applied in principle to any waste type</li> <li>particularly suited to highly variable inlet gas compositions (e.g. hazardous wastes)</li> </ul>
Plant size range	<ul style="list-style-type: none"> <li>not restricted but generally applied to medium/large plants</li> </ul>
New/existing	<ul style="list-style-type: none"> <li>not restricted</li> <li>applied when converting existing wet FGT systems to EC/2000/76</li> </ul>
Inter-process compatibility	<ul style="list-style-type: none"> <li>high operating temperatures make the process very compatible with SCR as no reheating of FG is needed</li> </ul>
Key location factors	<ul style="list-style-type: none"> <li>low plume visibility</li> <li>no liquid effluent is produced</li> <li>residue can be recycled</li> <li>safe reagent</li> </ul>

**Table 6.5: Assessment of the applicability of the combined dry sodium bicarbonate and SCR FGT system**

## Economics

Higher capital costs than dry systems due to the addition of a scrubber. Similar capital costs if a scrubber in good condition already in place (e.g. converting existing wet FGT to EC/2000/76)

Low operational costs due to:

- no need to reheat FG before entering the SCR (low emissions of SO<sub>2</sub>/SO<sub>3</sub> and temperature around 200 °C)
- no liquid effluents to treat
- very low excess of sodium bicarbonate.



**Driving force for implementation**

This technique is suitable when:

- existing wet FGT systems must comply with EC/2000/76 (introduction of SCR)
- hazardous waste with a highly variable inlet gas composition must be incinerated
- FGT must comply with emission limit values lower than EC/2000/76.

**Example plants**

Information not supplied.

**Reference literature**

[64, TWGComments, 2003]



## 7 CONCLUDING REMARKS

### 7.1 Timing of the work

The first plenary meeting of the TWG was held in December 2001. The first draft was then sent for consultation in May 2003. Nearly 4000 comments were submitted on the first draft. These were assessed and integrated into the document and the second draft, including proposals for BAT conclusions, was sent out in April 2004. A similarly very large number of comments were received on the second draft document. The majority of these were assessed prior to the final plenary meeting of the TWG which was held in November 2004. Four weeks before the final plenary meeting a completely revised version of the BAT chapter was supplied to the working group in the meeting background paper. This paper also contained a lengthy and thorough assessment of the comments made, and the rationale for the revised BAT proposed to the TWG. The final plenary TWG meeting focused upon agreeing the BAT conclusions. After the final meeting there were short consultations on the modified sections relating to BAT conclusions and on the concluding remarks and executive summary.

One year before the start of this information exchange Directive 2000/76/EC on the incineration of waste (WID) was finalised. WID sets binding operational and performance standards for the majority of situations where wastes are thermally treated, including where wastes are treated in dedicated waste treatment installations (which were the subject of this information exchange on BAT) and where wastes are co-incinerated in other installations (which were not part of the scope of this work). The standards set out in WID are, in the main, applicable to new installations from 2002 and to existing installations from 28 December 2005. The work on the BREF has therefore coincided with a period when the industry and Member States have been taking the steps required to implement the WID. Information from experience of implementing WID has to some degree been fed into the BAT information exchange. However, although data was supplied from those Member States who have for some years applied standards similar to those in the WID, with the WID being in the process of implementation, the information supplied was partial, and therefore incomplete. **It is recommended that the revision of the BREF draw specifically from Member State and Industry experience of implementing WID, examining in particular the difference between newly constructed installations and those that have been upgraded.** This may then usefully result in more detailed BAT conclusions regarding the techniques and performance that might be expected in each of these situations.

The **suggested date for the revision of this BAT reference document is 2010**, with commencement of information gathering to commence at least one year prior to this date.

### 7.2 Sources of information and information gaps

During this information exchange Member States and industry submitted a very large number of documents. Over 350 electronic information sources were submitted in total, with a similar number provided as hard copy either by post or by hand during meetings and site visits. The total number of pages of information supplied ran into many thousands. Some of the information was overlapping and therefore, not all of the documents supplied are referenced in the BREF.

Some very substantial contributions were made at an early stage of the project, which formed the cornerstones for the first chapters including the techniques to be considered in the determination of BAT (Chapter 4). In particular:

- detailed BAT documents were provided by Germany, Austria and Netherlands
- industry provided emissions and technique surveys specifically produced for the BREF project
- reports on particular techniques were provided by organisations, industry and many Member States
- individual TWG members dedicated large amounts of their own time to reading and commenting on the drafts produced and to producing contributions for the project.

EIPPCB and TWG members together made site visits to 29 installations in 9 different countries: Belgium, Denmark, Finland, Germany, Japan, Norway, Portugal, Spain and Sweden. These site visits were held early in the project and helped to give an understanding of the industry as a whole and of specific techniques. A standard data sheet was developed to gather information during these visits and reports on the visits were made available to the TWG by posting them on the members' workspace. Throughout the project there was very good and open communication with active TWG members in industry and Member States, although not all TWG members played an active role in the project. The consultation rounds on the draft BREF provided a great deal of specific constructive feedback from the TWG members. Such comments were crucial to the development of the BREF, although they were also accompanied by a very large number of comments expressing desires or opinions that were difficult to use where they were not well supported by information.

The project generated huge interest throughout, reflecting the great interest that the subject generally attracts. At the time of the second plenary TWG meeting there were an unprecedented 109 TWG members. Consultations on the first and second drafts of the BREF generated an equally unprecedented number of comments, with over 7500 comments submitted using the EIPPCB consultation spreadsheet, and very many pages of separate submissions. Because of the large amount of work required to deal with just the comments that were received by the consultation deadlines, the EIPPCB was not able to give full consideration to those contributions that were received after the consultation periods closed. Although the majority of TWG members submitted their comments within the consultation periods set (standard 8 weeks plus extra for vacation periods) some were unable to do so, and stated that the consultation periods were too short. Amongst the submissions received after the deadline, of particular note were 33 varied documents submitted by industry during the months following the close of consultation on the second draft. These documents split the BREF into various sections and provided the combined comments and suggested revisions of a number of the industry experts. While some of these submissions were used, the need to prioritise comments received during the consultation period meant that this was not the case with all. It is therefore **recommended that these submissions should be fully reviewed and taken into account when the BREF is reviewed.**

Good data was submitted on emissions, particularly emissions to air, although averaging periods and data standardisation sometimes differed, or were not given. Emissions data regarding the majority of the priority substances released to air was plentiful and of good quality, reflecting the standardisation and greater consistency of monitoring and reporting brought about by European level regulation. However, a lack of confidence in data quality prevented the establishment of quantitative BAT emission levels for the majority of those substances not included in Directive 2000/76/EC.

Quantitative cost data was supplied regarding gate fees, treatment costs, the costs of entire installations and of individual techniques. The majority of this was derived from individual studies. However, because of variations in the way in which cost data is compiled, the data supplied were mostly difficult to compare and thus the construction of cost curves for various techniques was generally not possible. **It is recommended that the revision of the BREF is preceded by studies that establish and gather the data that on a wider basis allows a more precise assessment of:**

- **the impact of plant size on the economics of the adoption of various techniques e.g. SCR**
- **the comparative affordability and benefits of the adoption of techniques in the sub-sectors of the industry (i.e. municipal, hazardous, sewage sludge etc.)**
- **comparative emissions avoided with the cost of applying various techniques**
- **the change in waste treatment costs that result from the use of various emission reduction techniques with respect to plant type and size.**

Cross-media effects were often not well quantified, and in many cases only a qualitative statement could be made. Data on raw material consumption was provided for some techniques but availability and quality was variable – this may be a reflection of the general (and arguably suitable) emphasis of the industry upon controlling emissions rather than consumptions.

Early on in the project it was noted that the incineration sector comprised a number of sub-sectors and the scope of the information exchange was derived during discussions in the first plenary meeting. However, the information exchanged was predominantly concerning the municipal and merchant hazardous waste sub-sectors. Relatively little information was provided concerning the other identified sub-sectors e.g. clinical waste, industrial wastes, mixed waste incinerators. The final document reflects the balance of the information provided and this resulted in relatively little information regarding some sub-sectors. The evidence presented in the BREF was considered sufficient to conclude on general BAT conclusions for the sector as a whole, with some sub-sector specific conclusions, but did not support the drawing of more detailed sub-sector specific emission levels.

In finalising the BAT conclusions it was noted that plant size has a great influence upon the economic viability of certain techniques, with small installations suffering far greater increases in cost per unit of waste treated than larger installations. The need to take account of the general applicability of the BAT conclusions in relation to the actual large variation in installation sizes seen, lead to the quantitative BAT associated operational emission levels ranges being broadened. This is therefore a factor to take into account when comparing the actual performance of individual installations against the BAT performance ranges given. In order to provide a more detailed understanding of the installation size and type size relationship to BAT, **it is recommended that the revision of the BREF seeks to establish BAT associated emission performance ranges that more closely take account of plant size and waste type factors. In addition, it is also recommended that the revision examines whether it is possible to draw more specific BAT conclusions for:**

- **mixed waste installations (e.g. techniques used and possible benefits of mixing various waste streams)**
- **industrial non-hazardous waste installations.**

Very little quantitative emission was supplied regarding the raw gas concentrations seen after the combustion stage (i.e. prior to gas cleaning). This made it impossible to carry out a detailed comparative evaluation of the techniques used at the combustion stage. Therefore, the conclusions drawn on this are largely derived from a consensus of expert opinion and overall installation performance, rather than a hard evaluation of techniques applied and mass balance data at the combustion stage. In particular it was not possible to evaluate the impact on combustion performance and emissions that might arise from detailed combustion design features. Because the emphasis of IPPC is upon techniques that prevent pollution (as opposed to abatement techniques) it is therefore **recommended that the revision of the BREF should study combustion design features in more detail with a view to evaluating their role in pollution prevention.**

### 7.3 Degree of Consensus reached

The conclusions of the work were agreed at the final TWG meeting in November 2004. There was a very good general level of consensus. There was full agreement, and no split views, in relation to the technique related BAT. There was also generally good consensus upon the quantitative BAT, although the operational emission levels associated with the use of BAT did give rise to some split views. One Member State and the Environmental NGO recorded split views in relation to many of the BAT associated emission levels for releases to both air and water. Their rationale for these split views included, the data in the BREF, and several examples of installations achieving emission levels below those agreed by the remainder of the TWG as BAT.

### 7.4 Other specific notes and issues

#### 7.4.1 Existence of installations with operational emission levels below those concluded as BAT

There are a number of installations in Europe that, for some of the emission parameters listed, already achieve operational levels below the lower end of the ranges given in table 5.2 and table 5.4 (BAT associated operational emission ranges for releases to air and water). However, the TWG concluded that these lower emission values could not be described as “generally achievable using BAT”. The rationale for this was that, whilst achieved in some specific situations, local variations in waste types and economic situations, meant that such lower emission levels were not considered to be BAT in general for the sector as a whole.

#### 7.4.2 Comprehensiveness of Table 5.3 on selection criteria for FGT systems (BAT 37)

Table 5.3 in Chapter 5 is not considered to be comprehensive as other subdivisions of the FGT systems mentioned are known to exist. In particular, the evaluation of each of the FGT systems presented, may change according to the FGT reagents used e.g. typically lime, sodium bicarbonate or sodium hydroxide.

### **7.4.3 Use of dry FGT systems at certain hazardous waste incinerators (BAT75)**

BAT 75 states that at hazardous waste incinerators feeding wastes of “highly varying compositions and sources, the use of wet FGT, as described in 4.4.3.1, is generally BAT...”. The TWG noted that dry FGT is also applied at some hazardous waste incinerators treating such wastes, that such installations comply with WID emission levels and that dry systems may have specific local advantages where there are particular restrictions e.g. on the use or discharge of water. Hence, although insufficient information was available to judge whether dry systems were also BAT for such HWIs, it may be the case that they offer overall advantages in some local circumstances.

### **7.4.4 Impacts of energy pricing and policies on energy efficiency**

In some European Member States green electricity schemes support, to varying degrees, the production of electricity from waste. The TWG noted that such subsidies were much less common for the supply of heat/steam, although they too represent a potential means of energy recovery. It was also noted that the absolute and relative prices (the price actually received by the operator including any subsidy) for electricity or heat/steam sales had a great influence upon the energy recovery strategy adopted and hence the actual design of installation.

Although electricity supply on its own is often the energy recovery option selected, CHP and heat/steam supply to reliable consumers provides a greater opportunity to increase the percentage recovery of the energy value of the waste. It may then be seen that policy measures such as “green steam” subsidies, and policies that improve the availability to incineration installations of customers/contracts for heat/ steam use (e.g. land use planning policy, energy policy, renewable energy quota obligations and subsidies, supply of district heating/cooling networks) can play a very important role in enhancing the overall ability of the waste incineration sector to improve its energy efficiency at both an installation and sector level.

In some locations, the adoption of such policies and measures is undertaken in part because of the contribution that waste derived energy may make in replacing energy that would otherwise be derived from fossil fuel derived energy sources. Where the energy production replaced is largely or wholly of fossil fuel origin, this may then be translated as savings in total carbon dioxide emissions from energy supply.

### **7.4.5 Competition and regulatory impacts across waste treating industrial sectors**

The incineration industry in Europe is exposed to greatly varying degrees of competition depending on waste type, geography, local legislation and policy. At one extreme installations are publicly owned, operated and funded, may have long-term contracts guaranteeing waste supply and energy purchase, and are permitted to increase charges for incoming wastes in order to raise capital for any required upgrades. At the other extreme, installations are entirely privately funded and operate in a global market for wastes, without any such security.

Where competition for wastes exists, within the limits set by legislative controls on waste movements, waste holders can send their wastes to the installation of their choice, and the relative cost of the options available will, in general, be a key driver that ultimately determines the installation selected. This being the case, installations with lower costs may be expected to “win” more contracts and hence treat more wastes.

The enforcement of environmental regulations, and the detail of the standards and emission values that those regulations require, themselves determine the techniques, investments and hence costs that are borne by the regulated industry. Therefore it can be clearly seen that, when a given waste may be treated in various sectors, the relative regulatory controls may, in a free market, have a significant impact on the destination of the waste. Ultimately, this may then lead to a situation where installations with higher environmental requirements (and higher costs) are penalised. It can therefore be seen that, in such situations, particular care is required when considering the emission values and other requirements that are to be placed upon all industries competing in such markets. This issue is also noted in WID (recital 10).

### **7.4.6 Development and implementation of waste strategies**

The degree to which incineration is utilised as a waste treatment option varies greatly from Member State to Member State and from region to region. In general those Member States with the highest levels of landfill have the lowest levels of incineration. The progressive implementation of Directive 1999/31/EC on the landfill of waste will result in reductions in the amount of biodegradable waste going to landfill. Particularly where reliance upon landfill has been the greatest, alternative waste treatment and disposal capacity will need to be provided for those wastes whose production is not prevented. In such cases, an expansion in thermal treatment capacity may therefore be anticipated, accompanied to some degree by an expansion in other treatments, including recycling.

The development and effective implementation of waste strategies at various levels (Member State, Regional and Local) is an important tool that can help ensure that effective, well planned and organised waste management is provided, whilst ensuring waste management hierarchies are observed. Such plans may help developers of thermal treatment installations to:

- a) ensure that the size of the installations they propose are complimentary to the waste strategy in place
- b) identify suitable locations for installations.

### **7.4.7 Markets and standards for bottom ash and other residues**

The degree of utilisation of thermal treatment residues in Europe varies greatly. In some cases almost all bottom ash is sent for disposal, in others a very large proportion is used, often for construction purposes after treatment. In general, the Member States that have been able to increase ash use (usually for bottom ash but sometimes also for certain fractions of fly ashes e.g. boiler ash) and thereby reduce disposal, are those that have developed appropriate standards for the use of ash, and for their sampling and quality testing.

In some cases Member States have extended policy further to the identification of zones where the various grades of incineration ash may be used as aggregate replacement, the environmental protection measures required when they are used, and the differing levels of quality testing required depending upon the environmental risk in the zone concerned. In such a way it has been found possible to address the potential pollution concerns regarding such uses of waste materials. The standards developed, seek to address these pollution concerns, and may then themselves become additional criteria for thermal treatment installation developers to consider when choosing those techniques and treatments that have a particular impact upon residue quality.

Such measures are generally seen to improve the market for the use of bottom ash and therefore reduce the amount of waste going for disposal, whilst also displacing the use of the raw minerals they replace. In other cases, member states adopt measures that aim to improve the landfill behaviour of the incineration residues.



The other main residues from waste incineration are those arising from flue-gas treatment. These are partially recovered in some cases (some industrial processes are used to recover certain fractions of some FGT residues), but in general the residues are sent for disposal, often by landfill and commonly following specific treatments. In some cases FGT residues are placed in salt mines where they are used as backfill. The price of FGT treatment, disposal or recovery can have some impact upon the techniques adopted for FGT, with higher recovery/treatment/disposal prices generally encouraging the adoption of wet flue-gas treatment systems which can produce lower quantities of solid residues than other systems. This situation is not however simple, and as indicated by the BAT conclusions in this document, the selection of FGT systems requires a multi-criteria assessment that considers a very wide range of drivers (e.g. water consumption and release, energy consumption, etc) in order to arrive at a balanced overall solution.

#### 7.4.8 Co-ordinated education and demonstration of health/environmental impacts

In this document it is reported that the results of European health impact assessment studies, on the basis of current evidence and modern emission performance, suggest that the local impacts of incinerator emissions to air are either negligible or not detectable. However, despite this evidence it is the perception of incineration, and its impacts that presents one of the major challenges to the sector, particularly in respect of new developments. Despite significant efforts on the part of developers and local authorities to provide information concerning the impacts and risks, proposals for new installations, in many cases, remain the cause of great public concern. Concern over new development is not however unique to waste incineration. To some degree other waste treatments plants, non waste industries, commercial, retail and infrastructure developments may all meet public and political resistance. During this information exchange, some information was submitted in relation to the actions that have been taken by the industry in order to address public concerns. It is clear that this is a matter which, although of greater significance in some locations than others, is of general interest to the European incineration industry. It is therefore **recommended that the industry and those with responsibility for developing and implementing waste strategies continue to develop their strategy in this area.**

### 7.5 Suggested topics for future R&D projects

In addition to the subjects already noted in this Concluding Remarks chapter, for the revision of the BREF the following topics were suggested for further investigation, with a view to establishing BAT conclusions where possible:

- information regarding the techniques used to, and costs of, upgrading existing installations – such information may be derived from experience of implementing WID in Member States and might usefully be compared with the costs/performance at new installations
- the more detailed cost information that is required to undertake a more precise assessment of variations in technique affordability with plant size and waste type
- information regarding smaller installations – very little information was provided regarding small installations
- installations that treat industrial non-hazardous wastes and those that treat mixtures of wastes
- a more detailed evaluation of the impact on pollution prevention of detailed combustion design features e.g. grate design
- further information on emerging techniques
- ammonia consumption and emission (mainly to air and water) levels for different FGT systems (mainly wet, semi-wet and dry) and their relative NO<sub>x</sub> reduction efficiency
- the impact of the dust removal temperature range upon PCDD/F releases to air and residues
- further experiences with continuous emissions monitoring for Hg (to air and water).

Other important recommendations for further work beyond the scope of this BREF but arising from the information exchange are:

- the need for consideration of the overall impact of competition for waste treatment, in particular competition from industries co-incinerating wastes – a study of such might usefully include consideration of: relative reliability of, and risks to, the supply of the waste management service; overall emissions and energy recovery according to various degrees of diversion, and; consider and identify key risk factors e.g. waste fuel quality assurance
- it may be useful to assess the impact on adopted waste strategies (i.e. the balance of technologies used on a national scale), and on achieved thermal treatment installation efficiencies, of the degree of integration of energy and waste management policy in EU Member States (and other countries). Such studies may identify how policy on energy and waste interact and give examples, both positive and negative
- the need to understand in more detail of the impact of absolute and relative energy prices (electricity and heat) upon the typically achieved energy efficiency of installations, and the role and impact of subsidies and taxation schemes
- the identification of the typical barriers to developing new installations and the approaches that have proved successful
- the development of suitable standards for the use of bottom ash – such standards have proved helpful in improving markets for the use of bottom ash
- the costs and benefits of further reducing emissions from the waste incineration industry when compared to reductions at other industrial and anthropogenic sources of pollution.

The EC is launching and supporting, through its RTD programmes, a series of projects dealing with clean technologies, emerging effluent treatment and recycling technologies and management strategies. Potentially these projects could provide a useful contribution to future BREF reviews. Readers are therefore invited to inform the EIPPCB of any research results which are relevant to the scope of this document (see also the preface of this document).

## 8 REFERENCES

- 1 UBA (2001). "Draft of a German Report for the creation of a BREF-document "waste incineration"", Umweltbundesamt.
- 2 infomil, N. (2002). "Dutch notes on BAT for the incineration of waste".
- 3 Austria, F. e. a.-ö. (2002). "State of the art for waste incineration plants".
- 4 IAWG (1997). "municipal solid waste incinerator residues", elsevier, 0-444-82563.
- 5 RVF (2002). "Energy recovery by condensation and heat pumps at WTE plants in Sweden", RVF.
- 6 EGTEI (2002). "Draft background document on the waste incineration sector".
- 8 Energos (2002). "Technical Literature regarding Energos Processes".
- 9 VDI (2002). "Thermal waste treatment: state of the art - a summary" The future of waste management in Europe 2002, Strasbourg.
- 10 Juniper (1997). "The Market for Pyrolysis and gasification in Europe".
- 11 Assure (2001). "A profile of incineration in Europe", Brussels.
- 12 Achternbosch (2002). "Materials flows and investment costs of flue gas cleaning systems of municipal waste incinerators", Institute for technical chemistry Karlsruhe, Germany, FZKA 6726.
- 13 JRC(IoE) (2001). "NO<sub>x</sub> and dioxin emissions from waste incineration plants", EUR 20114 EN.
- 15 Segers (2002). "A new secondary air injection system for MSW plants", <http://www.scientecmatrix.com/tecma/scientecmatrix.nsf/fMain?openform&ot=f&oc=waste>.
- 17 ONYX (2000). "Application for IPC Permit for EFW plant, Southampton, UK".
- 18 italy (2002). "DISMO Thermal Oxidation Process".
- 19 Babcock (2002). "Water cooled grates", <http://www.bbpwr.com>.
- 20 EKOKEM (2002). "BAT Submission by Ekokem, Finland".
- 21 FNADE (2002). "Comments provided to TWG on 6 Questions Posed".
- 22 Mineur (2002). "Auswirkungen betriebstechnischer optimierungen auf die emissionen bei der verbrunnung van klarschlamm", VERA Incinerator, hamburg.
- 23 VanKessel (2002). "On-line determination of the calorific value of solid fuels", Elsevier Preprint (submitted).
- 24 CEFIC (2002). "thermal treatment technologies for waste".
- 25 Kommunikemi (2002). "Pre-treatment of packed waste and 3 step flue gas cleaning at KK, DK".

## References

---

- 26 RSP (1999). "Investigations into the efficiency of different flue gas cleaning systems for incineration plants", Reimann, sunshine and partner GmbH.
- 27 Belgium (2002). "Flemish experiences with dioxin abatement and control in waste incinerators", VITO.
- 28 FEAD, C. (2002). "Energy techniques for municipal waste incinerators- proposed outline", FNADE, personal communication.
- 29 Energysubgroup (2002). "Energy recovery from waste incineration plants - paper".
- 30 UBA (2002). "Status report on CO2 emission saving through improved energy use in MSWI plants", UBA.
- 31 Energysub-group (2003). "Personal communication", personal communication.
- 32 Denmark (2003). "Corrosion and inconel cladding".
- 33 Finland (2002). "Recovered fuel use in fluid bed combustion and gasification", VTT Foster Wheeler.
- 35 Renova (2002). "EIPPCB site visit Sweden / Finland April 2002", personal communication.
- 36 Gohlke (2002). "The SYNCOM plus process", 3-935317-13-1.
- 37 Biollaz (2001). "Better quality MSW residues at lower cost (the PECK process)" Incineration 2001, Brussels.
- 38 Vehlow (2002). "Bottom ash and APC residue management" Power production from waste and biomass IV, Helsinki, 951-38-5734-4.
- 39 Vrancken (2001). "Vergelijking van verwerkingsscenario's voor restfractie van HHA en niet-specifiek categorie II bedrijfsafval", VITO.
- 40 EURITS (2003). "List of techniques for consideration as BAT", EURITS.
- 41 EURITS (2002). "Overview of information on Eurits members".
- 42 ISWA (2002). "Energy from waste - State of the art report - Jan 2002", ISWA.
- 43 Eunomia (2001). "Costs for municipal waste management in the EU".
- 44 RVF (2001). "Energy from waste: a inventory and review of dioxins [in Sweden]", RVF.
- 45 FEAD (2002). "Emissions of MWI plants for the BREF on waste incineration".
- 46 Cleanaway (2002). "Letter to IPPC Bureau", personal communication.
- 48 ISWA (2003). "APC residue management - an overview of important management options", ISWA.
- 49 Denmark (2002). "Clinical waste at I/S Amagerforbraending, Copenhagen", personal communication.

- 50 CNIM (2003). "Possible improvements to energy recovery efficiency and their counterparts", personal communication.
- 51 CNIM (2003). "Energy cycle optimisation - check list for determining local conditions", personal communication.
- 52 Reimann (2002). "Experiences with TMT for mercury minimization in waste water from waste incineration".
- 54 dechefdebien (2003). "FGC techniques - proposed outline", CNIM, personal communication.
- 55 EIPPCBsitevisits (2002). "Site visit reports from EIPPCB".
- 56 UKEnvAgency (2002). "Solid residues from municipal waste incinerators in England and Wales", UK EA.
- 57 Alstom (2003). "The NID flue gas cleaning system".
- 58 Andersson (2002). "PCDD/F removal from flue gases in wet scrubbers - a novel technique".
- 59 CEFIC (2002). "The dry sodium bicarbonate flue gas cleaning process".
- 60 Reimann (2002). "De-NOx technologies including a comparison of SCR and SNCR".
- 61 SYSAV (2002). "Selection of SCR for reconstructed process in Malmo", personal communication.
- 62 Tyseley (2001). "Reports for review of operating permit AS9216".
- 63 Langenkamp (1999). "Mercury in waste incineration", JRC, EUR 18978 EN.
- 64 TWGComments (2003). "TWG Comments on Draft 1 of Waste Incineration BREF".
- 66 UllmansEncyclopaedia (2001). "Encyclodaedia of Industrial Chemistry 6th Edition".
- 67 Inspec (2004). "Filtration p84", <http://www.p84.com/filter.html>.
- 68 Ebara (2003). "Comments of Ebara on first draft BREF and additional information supplied".
- 69 Thermostelect (2003). "Information supplied to EIPPCB during site visit".
- 70 USEPA (1994). "NOx control technologies applicable to municipal waste combustion".
- 71 JRC(IoE) (2003). "N2O emissions form waste and biomass to energy plants".
- 72 El-Halwagi (1997). "Pollutionm prevention through process integration", 0-12-236845-2.
- 73 Rijpkema (2000). "MSWC salt residues; Survey of technologies for treatment".
- 74 TWGComments (2004). "TWG Comments on Draft 2 on Waste Incineration BREF".



## 9 GLOSSARY

### Symbols

~	More or less. approximately
EUR	Euro, EUR (European currency)
\$	US dollar

### A

AC	Accession Countries to the European Union
ACC	Air-cooled condenser
APC	Air Pollution Control - a term applied the flue-gas treatment (FGT) equipment. Also referred to as FGC (flue-gas cleaning).
APC residues	The residues that arise from air pollution control equipment, including the reacted and unreacted reagents, but excluding the fly ash portion.

### B

Biohazard	A Biohazard (Biological hazard) is one which is posed to humans by a biological organism, or by a material produced by such an organism.
Boiler ash	Fly ash collected in a boiler
BF	Bag Filter
BFB	Bubbling Fluidised Bed – a type of fluidised bed (see also CFB)
BHF	Bag House Filter
BREF	Best Available Techniques Reference Document

### C

CAPEX	Capital expenditure
CEN	European committee for normalisation
CHP	Combined Heat and Power
COD	Chemical oxygen demand
CFC(s)	Chloro Fluoro Carbons
CFB	Circulating Fluidised Bed – a type of fluidised bed where a proportion of the off-gas is recirculated to the combustion chamber
CFD	Computerised fluid dynamics - a modelling technique used to predict gas flow and temperature in incinerators and other systems.
COMAH	Control of Major Accidents and Hazards Directive
CV	Calorific Value e.g. in MJ/kg

### D

Deacon Process	A chemical reaction whereby chlorine gas is formed from HCl under certain conditions.
Destruction	e.g. destruction of waste – this refers to the process of chemical conversion of mainly molecular organic species contained in the waste. Carbohydrates for example are converted into oxides of carbon and hydrogen.
DRE	Destruction and Removal Efficiency - the percentage of a substance fed to an incineration process that is not then emitted from the chimney stack
DE	Destruction Efficiency - the overall percentage of the substance that is fed to an incineration process that is destroyed and not then emitted to <u>all</u> combined environmental media.
DH	District heating – a network supplying heat via hot water or steam
DS or d.s.	Dry Solids - the mass of a substance after the drying of its moisture content - standard temperature techniques for this are defined in literature.

### E

EC	European Commission
EMS	Environmental management systems
EU	European Union

## Glossary

---

EU+	European Union + EFTA (European Free Trade Association) countries + Candidate countries
EUR	Euro (European currency)
EIPPCB	European Integrated Pollution Prevention and Control Bureau (Seville)
EP	Electrostatic Precipitator
ESP	Electrostatic Precipitator
<b>F</b>	
FB	Fluidised Bed – see also BFB and CFB for common types
FBC	Fluidised Bed Combustion
FD	Forced draught – often used in the context of force draught fans which use positive pressure to activate (typically) down stream FGT equipment (see also ID)
FGC	Flue-gas cleaning (techniques) – also referred to as FGT and APC
FGR	flue-gas recirculation –involves recirculating flue-gases to the furnace
FGT	Flue-gas Treatment (techniques) - also referred to as FGC and APC
FGT residues	Residues arising from flue-gas treatment stages including fly ash and reacted and unreacted reagents
Filter ash	fly ash collected in flue-gas treatment devices, typical used to refer to that collected in fabric filters or ESPs
Furnace	the part of an installation where combustion commences or is carried out
Fuzzy Logic	A term used to describe a computing network that receives and computes multiple signals by means of a logic system to control operational parameters within pre-defined set points.
<b>G</b>	
GHG	Greenhouse Gases e.g. CO <sub>2</sub>
Grate	A mechanism used to transport waste in a furnace – grates are commonly used for MSW incineration
<b>H</b>	
Hearth	part of a furnace
HW	Hazardous waste
Haz Waste	Hazardous waste
HWI(s)	Hazardous waste incineration/incinerator(s)
HFC(s)	Halogenated Fluorocarbons
HM	Heavy metal(s)
<b>I</b>	
ID	Induced Draught - usually referred to in the context of induced draught fans that are used to draw incineration gases through the incineration plant
IEF	Information Exchange Forum (see Preface)
IPPC	Integrated Pollution Prevention and Control (see Directive for definition)
IR	Infrared
<b>J</b>	
JRC	Joint Research Centre - the part of the EC within which the IPPCB is located.
<b>K</b>	
Kiln	see furnace – commonly used to refer to “rotary kiln” which is a type of combustor commonly used, particularly for hazardous wastes
<b>L</b>	
Lab smalls	Term typically used to define the waste that comes from laboratories. Typically in small quantities but usually very varied in composition



LCA	Life Cycle Analysis: tool allowing consideration of wide environmental impacts of a suite of 'processes' within a certain, usually very broad, boundary
LCV	LCV: Lower Calorific Value, e.g. in kJ/kg - the calorific value of a substance including its moisture content (which will consume a part of the total energy by transforming into vapour during the combustion process). (See also UCV)
LDL	Analytical lower determination level is the practical level for which a concentration can be accurately determined over a longer period. It is clear that this value is higher than the theoretical level of determination (LOD). The former is used in this text and is based on practical experience (e.g. drift), the latter is more theoretically correct. It is known that all installations comply with LOD.
LHV	Low Heat Value - the calorific value of a substance including its moisture content (see also UHV)
LOI	Loss on ignition – often referred to in the context of a test used for assessing organic content of materials
<b>M</b>	
M	Mega ( $10^6$ ) or million
MAH	Major Accident and Hazard (see also COMAH)
MBT	Mechanical Biological Treatment
Memory effect	The accumulation of various PCDD/F congeners in the plastic materials used in wet scrubbers
MS	Member State (One of the member states of the EU)
MSs	The Member States of the EU
MSW	Municipal Solid Waste
MSWI(s)	Municipal Solid Waste Incinerator(s)/incineration
MWI	Municipal Solid Waste Incinerator(s)/incineration
<b>N</b>	
n/a	Not available
n/a	Not applicable
n/a	Not applicable
NCV	Net calorific value or low heat value (LHV) - see also UHV
NMVOG	Non Methane Volatile Organic Compounds
NFFO	Non Fossil Fuels Option - a term applied in the UK for an electricity sale price subsidy for fuels not considered to be of fossil origin
<b>O</b>	
ODS	Ozone Depleting Substances - as defined by the Montreal Protocol
OPEX	Operating expenditure/costs
<b>P</b>	
PAH(s)	Polycyclic Aromatic Hydrocarbons
PCB	Polychlorinated biphenyl
PCC	Post combustion chamber - a term applied to the zone after the initial combustion zone where gas burnout occurs (also referred to as the secondary combustion chamber or SCC)
PCDD/F	Polychlorinated dibenzo-dioxins and polychlorinated dibenzo-furans
PIC(s)	Product(s) of Incomplete Combustion
PFI	Private Finance Initiative - a UK term for a scheme to bring private sector investment to support public sector projects
POPs	Persistent Organic Pollutants - as defined by the Stockholm and Basle Convention. Includes PCDD/F.

Power	The term power refers to electrical energy e.g. power generation/power plant/power output. Energy is expressed in J (Joule). Power in W (Watt). $1\text{ W} = 1\text{ J/s}$ .
PVC	Poly Vinyl Chloride
<b>Q</b>	
<b>R</b>	
RDF	Refuse derived fuel - this can also be referred to as waste derived fuel (WDF) or secondary recovered fuel (SRF) or recovered fuel (RF). The term refers to wastes that have been treated in some way in order to reach a particular specification and in doing so to improve its fuel characteristics.
RK	Rotary kiln – a type of furnace commonly used for hazardous wastes
RF	see RDF
<b>S</b>	
SCC	Secondary combustion chamber (see also PCC)
SCR	Selective Catalytic Reduction - a technique applied mainly for NO <sub>x</sub> reduction
SD	shut down
SNCR	Selective Non- Catalytic Reduction - a technique applied for NO <sub>x</sub> reduction
SS	Sewage sludge(s)
SSI	Sewage sludge(s) incinerator/incineration
Static hearth	a type of furnace where the structure does not move – waste transport may be achieved by batch intervention
Stepped hearth	a type of furnace designed as a series of steps – usually with a transport mechanism to move waste over the steps
SRF	see RDF
SU	start up
<b>T</b>	
TEQ	Toxic Equivalents (used for expressing PCDD/F - refers to the same groupings and calculations detailed in EC Directive 2000/76 on the incineration of waste)
TG	turbo generator
TOC	Total Organic Carbon (this excludes elemental carbon)
TWG	Technical Working Group on Waste Treatments (composed of experts from Member States, Waste Incineration industry, Environmental NGO and co-ordinated by EIPPCB)
TMT	A sulphide reagent used for heavy metal capture in WWT plants
<b>U</b>	
UHV	Upper Heat Value - the calorific value of a dried substance (see also LHV). The UHV is also referred to as the net calorific value UCV
UV	Ultraviolet
<b>V</b>	
VOC	Volatile Organic Compounds
<b>W</b>	
WDF	see RDF
WEP	Wet Electrostatic Precipitator - a FGT device.
WI	Waste incinerator/incineration
WID	Waste Incineration Directive EC/2000/76
W-t-E	Waste to Energy - a term use to describe incinerators that recover heat and/or electricity
WT	Waste treatment(s)

WWT	Waste water treatment
WWTP	Waste water treatment plant
<b>X</b>	
<b>Y</b>	
<b>Z</b>	

## Country and Currency Codes:

	Country Name	Abbreviation	Currency ISO Code
<b>EU countries</b>	Austria	A	EUR
	Belgium	B	EUR
	Germany	D	EUR
	Denmark	DK	DKK
	Spain	E	EUR
	Greece	EL	EUR
	France	F	EUR
	Finland	FIN	EUR
	Italy	I	EUR
	Ireland	IRL	EUR
	Luxembourg	L	EUR
	Netherlands	NL	EUR
	Portugal	P	EUR
	Sweden	S	SEK
	United Kingdom	UK	GBP
	<b>Accession countries</b>	Bulgaria	BG
Cyprus		CY	CYP
Czech Republic		CZ	CZK
Estonia		EE	EEK
Hungary		HU	HUF
Latvia		LV	LVL
Lithuania		LT	LTL
Malta		MT	MTL
Poland		PL	PLN
Romania		RO	ROL
Slovakia		SK	SKK
Slovenia		SI	SIT
<b>Other countries</b>	Australia	AU	AUD
	Canada	CA	CAD
	Iceland	IS	ISK
	Japan	JP	JPY
	New Zealand	NZ	NZD
	Norway	NO	NOK
	Russia	RU	RUB; RUR
	Switzerland	CH	CHF
	United States	US	USD

**Table 9.1: Country codes and currencies**Notes: Information from <http://eur-op.eu.int/code/en/en-5000500.htm>

## 10 ANNEXES

### 10.1 Economic overview of MSWI - Member State information

This Section of the BREF is taken largely from data already published by the European Commission [43, Eunomia, 2001]. The information refers only to MSWI.

#### Austria

Information concerning costs of incineration technologies and options in Austria are presented in Section 10.2.

#### Belgium

The waste policy in the three Belgian regions is aimed at the maximisation of the reduction of residual waste.

##### Flanders Region

The waste policy target in Flanders is a maximum production of 150 kg/yr per capita of residual waste by the year 2007.

The average gate fee for the incineration of municipal waste was EUR 87.5 per tonne in 2000. The Flemish government adds a levy to this tariff of EUR 6/t when energy recovery takes place and of EUR 12.7/t without energy recovery.

The landfilling of municipal waste (with the exception of non-recyclable sorted bulky waste) and the incineration of separately collected fractions (old paper and cardboard; glass packaging; metal packaging; plastic bottles and plastic packaging waste; drinks packaging; vegetable waste; vegetables, fruit and garden waste) has been legally prohibited by the Flemish government since 1st July 1998. The landfilling of combustible bulky waste has been forbidden since 1st July 2000. Only exceptionally is the landfilling of municipal waste still allowed – in 2000 789425 tonnes MSW was incinerated and 190412 tonnes MSW sent to landfill.

##### Brussels Capital Region

The cost price for incineration of residual household waste in the SIOMAB -incineration plant (operator: Net Brussels) of Neder-Over-Heembeek is calculated at EUR 37.18 per tonne (source: B.I.M., 1997). A better estimate of the real cost of incineration in the SIOMAB plant is probably the price charged by Net Brussels to municipalities in the Brussels Region for incineration of municipal waste. This price is EUR 62 per tonne.

Recent figures show that circa 40000 tonnes of Flemish waste is incinerated in this installation, together with the municipal waste from the Brussels Region (source: OVAM, 2001).

#### **Walloon Region**

In the Plan Wallon des Déchets, reference costs based upon current facilities were estimated at EUR 67 per tonne.

#### Denmark

65 % of waste from households was incinerated in 1999, equivalent to about 2 million tonnes. All incineration plants recover energy, either in the form of electricity and heat, or just as heat (distributed in district heating systems).

Prices for incineration of one tonne of domestic waste range from 500 – 740 DKK = EUR 66 - 99, excluding VAT, but including waste tax. Waste tax on incineration is 330 DDK = EUR 44 as of January 2001. These prices include plant investment costs and investment costs for CHP, and the plants are used to generate district heating (which gives a lower net cost per tonne and lower gate fee). Bottom ash is typically recycled (75 %) and the rest is sent to landfill. Flue-gas cleaning residues are hazardous waste and presently sent to Norway/Germany where they are deposited in landfills/mines, or sent to special/hazardous waste management sites (where the costs per tonne are higher).

### **Finland**

The Finnish waste incineration policy has mainly centred on the production of refuse-derived fuels for co-incineration (or other thermal treatment) in existing power and heat stations. This policy is being pursued (in part) in order to minimise costs, in a situation where there is already a large infrastructure for the distribution of heat from bio-mass and conventional fuel generating stations.

### **France**

Key factors explaining variation in costs are reported as:

- capacity
- utilisation rate
- type of energy recovery (electricity, heat, co-generation)
- type of disposal and transportation of residues.

The following figures are extracted from an assessment carried out in 2002 on the 42<sup>nd</sup>, and most recently constructed, MSWI built in France:

- investment costs: EUR 3.6 million/(t/h)
- operational costs: EUR 32/t average – however this cost is very variable, ranging from 18 to 42 EUR/t.

Operational costs may be derived as follows:

- 33 EUR/t of fixed costs (personnel, insurance, etc.)
- 13 EUR/t for waste elimination (bottom ash, fly ash) and
- -14 EUR/t of revenues from energy or residue sales.

The total resulting cost per tonne of waste treated is equal to 78 EUR/t (pay-off time of 15 years, an investment paid off at 100 % by a bank loan at 6 % interest rate, and a plant operating 8000 hours per year). [64, TWGComments, 2003]

Key influences identified for future variation in costs:

- technological developments
- evolution of regulations on emissions.

### **Germany**

Almost all of the thermal treatment facilities in Germany are waste incinerators. The capacity of other treatment options, such as pyrolysis plants are negligible. Most MSW incinerators in operation are grate incinerators. There is a great variety in plant size, flue-gas treatment and the further use of the generated energy. The costs of a grate incinerator with a capacity of 200000 tonnes per year and dry and wet flue-gas treatment generating electricity is given below in Table 10.2.

Generally, gate fees for waste incineration are in a range of EUR 64 to 460/t. In other sources a range of EUR 89 to 351/t is given. 50 % of all data on costs of waste incinerators are in a range of EUR 123 to 256/t (according to UBA).

The costs for different sized grate incinerators vary widely. They indicate scale economies. Table 10.1 gives an overview of the range of specific costs depending on the capacity of a grate incinerator with the same technical specification as the plant in Table 10.2:

Capacity (t/yr)	Specific treatment costs EUR/tonne
50000	230
100000	140
200000	105
300000	85
600000	65

**Table 10.1: Treatment costs for a MSW Grate Incinerator with varying capacity [43, Eunomia, 2001]**

The key factors contributing to the costs of waste incineration at present are identified as:

- choice of technology and the technical equipment (especially flue-gas treatment) of the plant
- plant size
- capacity and its utilisation
- plant availability
- the gate fee paid by Local Authorities. This is influenced by whether or not the Local Authority has to pay fees to the operator of the plant for a certain amount of waste, which they have to deliver to the plant. While contracts are often based on a definite amount of waste and are valid for a long period of time, the amount of waste has decreased within recent years
- the income from supplied energy. The amount of electricity and heat being generated and sold varies widely depending on the plant technology and the location of the plant
- the costs for chemicals and the disposal of residues from incineration.

A detailed cost breakdown for a 200000 tonne MSW facility in Germany is given in Table 10.2:

TOTAL INVESTMENT	Investment (EUR)	Payback Period (y/s)	Rate %	Annualised cost (EUR/yr)	Specific costs (EUR/t)
Site costs	368000		7	25700	0.13
Development of site	341000	25	7	29200	0.15
Construction costs	21629000	25	7	1856000	9.28
Technical installations and machinery	69740000	15	7	7657100	38.29
Electro technical installations	13280000	15	7	1458000	7.29
Fees	7349000	17	7	752800	3.76
Pre-financing	9219000	17	7	944200	4.72
<b>TOTAL</b>	<b>121925000</b>			<b>12723000</b>	<b>63.61</b>
<b>OPERATIONAL COSTS, independent of input</b>	EUR	Percentage		Annual costs EUR/yr	Specific costs EUR/t
Construction	21970000	1		219700	1.10
Technical installations and machinery	69740000	4		2789600	13.95
Electro technical installations	13280000	2.5		332000	1.66
Taxes and insurance	105357000	1		1053600	5.27
Management	2863000	10		286300	1.43
Auxiliary materials	3341000	5		167100	0.83
		number	EUR/person		
Labour		80	35790	2863200	14.32
<b>TOTAL</b>				<b>7711500</b>	<b>38.56</b>
<b>OPERATIONAL COSTS, input dependent</b>					
		EUR per m <sup>3</sup> /yr	EUR/m <sup>3</sup>		
Process water		51200	0.15	7900	0.04
Gas		1381440	0.20	282500	1.41
		t/yr	/t		
CaO		1000	79.2	79200	0.40
Ammonia		400	97.1	38900	0.19
	kg/t input				
Treatment of slag	334	66800	28.1	1878500	9.39
Treatment of ashes	8	1600	255.6	409000	2.05
Treatment of filter dust	22	4400	255.6	1124800	5.62
<b>TOTAL</b>				<b>3820800</b>	<b>19.10</b>
	MWh/t input	MWh/yr	EUR/MWh	EUR/yr	EUR/t
Credits for electricity	0.35	70700	46.0	3253300	16.27
<b>TOTAL Cost Per Year</b>				<b>21002000</b>	<b>105</b>
Cost per tonne input					

**Table 10.2: Grate MSW incinerator costs 200000 t/yr Germany [43, Eunomia, 2001]**



Key factors expected to influence future costs:

- many of the plants that have been built in recent years are equipped with simplified technology for flue-gas treatment. Assuming that future incinerators will be equipped with the less complex technology it can be expected that costs will decrease
- the regulation of waste treatment requires an end of the disposal of non pretreated waste with more than 5 % carbon content in landfills from the year 2005 onwards. A lack of capacity for waste incineration could be seen after this date and consequently gate fees of incinerators might increase.

### Greece

At present, no thermal treatment of municipal solid waste takes place in Greece.

### Ireland

There are currently no thermal treatment plants for municipal waste in operation in Ireland. Recent waste management plans include the construction of these.

An estimate of the cost to build and operate an MSW incineration plant of 200000 tonne capacity is presented below (based on Directive 2000/76/EC standards). This data is based on comparative experience in Denmark and the United Kingdom, but with reference to Irish conditions.

<b>Capital investments</b>	<b>EUR</b>
Civil works and buildings	23741660
Mech. and Electrical Equipment	45388468
Other	15108329
<b>Total</b>	<b>84238458</b>
<b>Operating costs</b>	<b>EUR</b>
<b>Fixed</b>	
Personnel	954297
Maintenance and replacement	890522
Unforeseen	125527
<b>Total</b>	<b>1988422</b>
<b>Variable</b>	
Maintenance and replacement	839782
Chemicals	890522
Other (consumables and residues)	1174520
Other (unspecified)	293630
<b>Total</b>	<b>3198454</b>
<b>Variable costs per tonne</b>	<b>16</b>

**Table 10.3: Estimated cost to build and operate a mass-burn MSW incineration plant of 200000 tonne capacity in Ireland**  
Source [43, Eunomia, 2001]

### Italy

In 1999, incineration covered 7.2 % of total municipal waste treatment in Italy. Most facilities at that time were reported to have been designed (and were being operated) according to poor standards regarding energy recovery (average 10 %) and emissions. Gate fees were varying widely, usually in the range 40 - 80 EUR/tonne.

3 major factors are reported to affect costs:

- funds to cover - partially or totally - the costs of construction (this allowed owners to avoid cost items referring to depreciation and interest)
- subsidies for the energy produced - subsidies for energy from waste have been paid for some years in Italy. Initially, under the scope of the “CIP6” provisions (deemed to boost the internal energy production), more recently with the “green certificates”. (Decree 79/99 and Decree 11 Nov 99, whose rationale is to foster the production of energy from non-conventional sources other than fossil fuels, thus contributing to the Kyoto commitments). The level of both subsidies is around 0.139 EUR/kWh and enables contracted facilities to cut down the fees by some 40 EUR/tonne (around 30 EUR/tonne more than normal prices paid for energy in Italy) - if operating at a medium to low energy recovery rate. Revenues and incidences on the gate fee are, of course, higher at higher energy recovery rates
- contributions for burning of packaging materials - as a means to “recover” packaging itself - paid by the mandatory Consortium of Packaging Producers (CONAI), set at 58 EUR/tonne, applies only on 30 % – 40 % of the waste being burned, which represents the percentage of combustible packaging out of total MSW at the site (to be assessed through sorting analyses). Such contribution, defined in 1998, has to be cut progressively, year by year, to EUR 3.5/tonne. Therefore, at present, this contribution increases revenues by EUR 16.5/tonne.

A national increase in incineration (mass burn and RDF) is forecast as consequence of legislative moves to reduce landfilling.

The latest generation of incineration facilities show some common features:

- all facilities recover energy (also in compliance with provisions of the national Waste Management Act that mandates it)
- throughputs are usually much larger than before (in the range 400 to 1000 t/d and more, e.g. Brescia, the new Milan facility, while previous facilities usually were at 100 – 400 t/d)
- many of the new facilities are well integrated in strategies for the abatement of the wet fraction inside the waste to be burned, both through source separation/composting and/or a screening step (e.g. Milan, Parona) that yields a mechanically sorted organic fraction to be later biologically stabilised. This last feature makes incineration more similar to MBT/RDF production with a fitting burning facility
- as a consequence, designed calorific values in normal operational conditions are therefore more and more set towards 10.5 – 12.5 MJ/kg (old facilities were most often around 8.5 MJ/kg).

### Model calculations for an Italian example:

For a facility with the following main features:

- combustion technology: mobile grate
- designed calorific value: 2900 kcal/kg (input waste coming from a screening step - though this has not been considered among costs, and treatment/disposal of the organic undersieve fraction has not been considered, either)
- energetic yield: around 25 %
- throughput: 1000 tonnes per day, three lines
- 300 operating days a year
- systems for abatement of emission fit for the purpose of fully complying with the Directive on Incineration
- rejects (by weight): 18 % bottom ashes; 3 % fly ashes; 20 % residues from gas cleaning.

The gate fee would be between EUR 41.3 and 90.3/tonne depending upon the subsidies awarded.

	Unit	Unit cost (EUR)	Total cost (in EUR)	Payback period	Interest rate (%)	Yearly depreciation (EUR)	Specific cost
<b>Investment costs</b>							
<b>Preliminary surveys, project, approval, etc.</b>			12303640		7 %		
			4132231				
<b>Land purchase (m<sup>2</sup>)</b>	200000	20.66		20	7 %	390053	
<b>Site preparation (excavation, levelling, access roads, link to technological networks)</b>			1239669	20	7 %	117016	
<b>Civil works</b>			42355372	20	7 %	3998047	
<b>Other civil works (sewerage, internal water supply network, fencing, etc.)</b>			1549587	20	7 %	146270	
<b>Treatment and control equipment</b>			80061983	7	7 %	14855759	
<b>Complementary works</b>			4648760	20	7 %	438810	
<b>Other equipment</b>			516529	7	7 %	95844	
			<b>Total depreciation</b>		<b>EUR 2004179944</b>	<b>EUR 66.81</b>	
<b>Operating costs</b>							
<b>Maintenance</b>							
Equipment and machinery (5 %)			4003099				
Civil works (1 %)			485537				
Other equipment (5 %)			25826				
<b>Manpower:</b>							
Accountants	7	35000.00	245000				
Directors	4	60000.00	240000				
Workers	69	30000.00	2070000				
<b>Consumables:</b>							
Water (m <sup>3</sup> )	80000	0.26	20661				
Combustible oil (litres)	270000		62500				
Combustible raw gas (N cubic meters)	5233800	0.15	811023				
Electric Energy (MWh)			206612				
Chemicals and lubricants			1042665				
Other consumables			929752				
<b>Disposal of residues:</b>							
Bottom ash(tonnes)	54000	75.41	4072175				
Fly ashes and other residues (salts, exhausted activated carbon filters, etc., tonnes)	15000	12913	1936983				
Other residues (other filters, exhausted catalysts, etc.)			129132 EUR				
<b>General expenses</b>			377479 EUR				
<b>Miscellaneous (analyses, etc.)</b>			516529	<b>Specific cost (EUR/tonne)</b>			
<b>Total operating cost</b>			<b>18217639</b>	<b>60.73</b>			
<b>TOTAL YEARLY COST</b>			<b>38259438.9</b>	<b>127.53</b>			

Table 10.4: Incinerator costs in Italy based on model calculations  
Source [43, Eunomia, 2001]

Key factors expected to influence future **costs** and/or **fees** are likely to be:

- full implementation of the Incineration Directive 2000/76/EC
- future reduction in the level of subsidies for the production of energy
- increased competition due to the privatisation of the market for energy. This may reduce income from energy and create upward pressure on waste charges/costs.

### **Luxembourg**

There is one thermal treatment facility, a municipal waste incinerator, in Luxembourg. The waste syndicate SIDOR is responsible for this MSWI. Gate fees of the facility and the amount of waste incinerated in the year 1999 are given in Table 10.5 below.

<b>Waste</b>	<b>Amount (t)</b>	<b>Gate fees (EUR/t)</b>
<b>Household waste</b>	78000	96.7
<b>Bulky waste</b>	8000	128.9
<b>Green waste</b>	550	96.7
<b>Market waste</b>	530	96.7
<b>Commercial waste</b>	33000	178.5
<b>Waste from water treatment (not sludges)</b>	450	96.7
<b>Production waste</b>	150	198.3
<b>TOTAL</b>	120680	120.7

**Table 10.5: Fees and expected amount of waste to be incinerated at SIDOR facility, Luxembourg in 1999**

Source [43, Eunomia, 2001]

Specific operational costs of the incinerator are given in Table 10.6 below. Values for the year 1998 are given. Those for 1999 are estimated. Taxes are included.

	EUR/t in 1999 (estimated)	EUR/t in 1998
<b>Incineration, depreciation</b>	30.8	
Margin 5 %	1.5	
Total	32.3	33.2
<b>Flue-gas treatment, depreciation</b>	13.2	
Margin 5 %	0.7	
Total	13.9	13.1
<b>Additional flue-gas treatment, depreciation</b>	10.1	
Margin 5 %	0.5	
Total	10.6	10.2
<b>Operation of new installations</b>		
By-pass (estimated)	1.4	
Homogenisation of waste (estimated)	1.0	
Total	2.4	0
<b>Treatment of bottom ash</b>	14.7	
Not combustible residues	0.6	
Margin 5 %	0.7	
Total	16.1	17.4
<b>Disposal of residues from flue-gas treatment</b>	6.9	
Margin 5 %	0.3	
Total	7.2	11.6
<b>Auxiliary materials</b>		
Lime: 13 kg/tonne of waste	1.2	
NH <sub>3</sub> :4 kg/tonne of waste	0.4	
Oil: 7 l/tonne of waste	1.0	
Gas: 13 m <sup>3</sup> /tonne of waste	2.4	
Other 8 kg/tonne of waste	1.5	
Margin 10 %	0.7	
Total	7.2	7.5
<b>Other costs</b>	12.4	
Margin 5 %	1.2	
Total	13.6	13.6
Credits for electricity (estimated)	-12.4	-10.0
<b>TOTAL OPERATIONAL COSTS</b>	<b>91.0</b>	<b>96.6</b>

**Table 10.6: Specific operational costs of the SIDOR MSWI in Luxembourg 1998 and 1999 [43, Eunomia, 2001]**

Some additional information related to the MSWI of the years 1998 and 1999 (estimated) is given below. The budget is based on 123152 tonnes of waste in 1998 and 120680 tonnes in 1999.

Item	EUR in 1998	EUR/t in 1998	EUR in 1999	EUR/t in 1999
Extraordinary expenses				
Installation for waste homogenisation, studies and tests	248000	2.0		
Installation for waste homogenisation, investment			273000	2.3
Ordinary earnings				
Selling of metal scrap	917	0.007	868	0.0007
<b>Ordinary expenses</b>				
Operational costs installation for waste homogenisation			124000	1.0
Operational costs additional installations for flue-gas treatment and incineration (incl. by-pass)	1204000	9.8	1492000	12.4
Operational costs - flue-gas treatment	1569000	12.7	1731000	14.3
Operational costs - incineration	3657000	29.7	4030000	33.4
Assurances	223000	1.8	223000	1.8
Costs for publication for sensitisation of the public and for education of workers	248000	2.0	372000	3.1
Maintenance of electricity generator	1980	0.02	1980	0.02
Labour costs (SIDOR)	118000	1.0	128000	1.1
Social security contribution of the employer	26000	0.2	28000	0.2
Office costs	15000	0.1	15000	0.1
Administration costs	20000	0.2	22000	0.2
Buying of electricity	9900	0.1	9900	0.1
Guard	112000	0.9	112000	0.9
Emission control (periodic measuring)	248000	2.0	248000	2.1

**Table 10.7: Extract from the budget Of SIDOR for the years 1998 and 1999 [43, Eunomia, 2001]**

Key factors explaining the costs of waste incineration at present are:

- additional technical equipment of the plant
- the credits for electricity
- treatment of residues
- amount of waste to be incinerated.

Key factors expected to influence future costs:

- see key factors at present.

### **The Netherlands**

The Netherlands has, for some time, had some of the tightest sets of regulatory standards for incinerators in Europe. Incinerator gate fees in 1996 were approx. EUR 110. More recent figures from OVAM suggest that gate fees varied from EUR 85 – 161 in 2003. There are high levels of re-cycling of the ash residues produced at Dutch plants. Only flue-gas cleaning residues are not routinely recycled.

Waste treatment technology	Specific capital investment (EUR/t annual capacity)	Treatment costs <sup>(2)</sup> (EUR/t treated)
Incineration	450 – 550 <sup>(1)</sup>	approx. 100
(1) 40 % is due to cleaning of flue-gas		
(2) Depreciation plus operation and maintenance (O and M) costs		
Source: F. M. L. J. Oorthuys and A. J. F. Brinkmann (1999) Benefits of Separation of Municipal Solid Waste, EXPOAMBIENTE '99, 10 – 14 November 1999, Lisbon, Portugal.		

**Table 10.8: Capital investment and treatment costs for MSWI in NL [43, Eunomia, 2001]**

A recent study used some assumptions (including a 15 % efficiency gain) to derive figures for the Netherlands of EUR 77 per tonne for a new 648 kt/yr facility, with sensitivity analysis suggesting a range between EUR 63 – 94 (for the same plant). The revenue from energy sales was assumed to be EUR 36 per tonne, equivalent to approximately EUR 0.05 per kWh. No information was given concerning the costs of ash treatment and disposal, although it is known that bottom ash is largely recycled in the Netherlands.

[74, TWGComments, 2004] Market prices for electricity are approx. 0.0271 EURO/kWh with a potential benefit for the renewable part (50 %) of 0.029 EURO/kWh. (Overall 0.042 EURO/kWh). The revenues are approx. 15 - 20 EURO/tonne. Costs for bottom ash recovery are approx. 9 EURO/tonne bottom ash.

### Portugal

European Investment Bank loans of EUR 45.4 million and EUR 42 million were awarded for incineration plants in Oporto (LIPOR) in 1999, and Lisbon (Valorsul) in 1998, respectively. A recent paper seeking to model disposal costs in the EU suggested figures of EUR 46 – 76/tonne, similar to those quoted for Spain below.

### Spain

The reported gate fees for incineration of MSW were reported at EUR 18 – 51 per tonne. Figures from Catalonia are EUR 28.5 per tonne though this takes into account only operating costs, and excludes depreciation on civil works, equipment and investment. The Ministry for the Environment estimates costs at EUR 52 – 73 per tonne.

Incineration benefits from a special subsidy for the electricity that has been produced. The effect of this is to reduce the above quoted costs to EUR 34 – 56 per tonne.

### Sweden

Sweden has 23 incinerators, 6 of which are larger ones (capacity of 200000 per year or more), the rest average a capacity of 40000 tonnes/yr. There are plans for almost as many more, as present and future changes in waste regulations improve the competitiveness of incineration (e.g. landfill tax, bans on landfilling of combustible waste and kitchen waste).

There are three incinerators with the capability of producing electricity in Sweden, but generally it is considered that the price of electricity has to increase in order to render this profitable. Almost all incinerators produce heat for district heating.

The incinerators in Sweden are mainly grate incinerators, the rest are fluidised bed incinerators. Some general size-cost relations are presented below for examples of Swedish incinerators producing electricity and heating:

	Heating	Power/heating	Heating	Power/heating
Capacity, tonnes/yr	40000	40000	300000	300000
Effect, MW	15	15	114	114
Investment EUR	13336000	24248000	52490000	95437000
Annuity, 7 %, 15 years lifetime	1464000	2662000	5763000	10478000
Operators	16	21	33	43
Staff costs EUR	640000	840000	1320000	1720000
Limestone and chemicals EUR	100000	100000	750000	750000
Operating and maintenance (2 % of investment) EUR	333000	606000	1312000	2386000
Landfilling of bottom ash (incl. tax, EUR 40/tonne) EUR	320000	320000	2400000	2400000
<b>Revenues:</b>				
Electricity (EUR 0.03/kWh) EUR	0	2818000	0	5770000
Heat (EUR 0.02/kWh) EUR	1835000	1360000	13760000	10198000
Gate fees (EUR 23/tonne)	920000	920000	6900000	6900000
<b>Total costs/tonne</b>	<b>71.4</b>	<b>113.2</b>	<b>38.5</b>	<b>59.1</b>
<b>Total revenues/tonne</b>	<b>68.9</b>	<b>127.4</b>	<b>68.9</b>	<b>76.2</b>
<b>Net revenue/tonne</b>	<b>-2.6</b>	<b>14.2</b>	<b>30.4</b>	<b>17.1</b>

**Table 10.9: Cost breakdown for various incinerators in Sweden**  
[43, Eunomia, 2001]

Assumptions made in the calculations in Table 10.9:

There are 7100 running hours/yr, the heating plant produces heat at 85 % efficiency, the heating and power plant produces heat at 63 % efficiency and electricity 22 % efficiency. The costs and revenues for heat, electricity, gate fees, and landfilling are uncertain. The actual investment costs naturally vary depending on site, state of the market, etc.

Bottom ash is not recycled and therefore has to be landfilled in Sweden, thus entailing a cost rather than generating a revenue.

**United Kingdom**

The majority of thermal treatment operations in the UK are mass burn incinerators. Some of these were designed to be combined heat and power plants but in practice, heat supply has been limited. This section therefore concentrates on mass burn facilities generating electricity only. There are fluidised bed plants as well as standard grate incinerators in operation. In addition, gasification and pyrolysis plants are being developed, whilst two facilities manufacture RDF for off-site use.

Contract prices for incineration plant show considerable variation. So do estimates of costs reported in the literature. For example:

1. a 1995 study looked at plant of 100 kt/yr, 200 kt/yr and 400 kt/yr, respectively. Again, all ash residues (350 kg per tonne waste) were assumed to be disposed of to landfill at GBP 10 per tonne. Ferrous metal sales were assumed to be 120000 per year, equivalent to GBP 20 per tonne for ferrous metal at 6 kg recovery per tonne of input. Using a discount rate of 10 %, and with gate fees calculated for both, a plant supplying electricity only (450 kWh/tonne), and a plant supplying combined heat and power, the results are shown in Table 10.10:

	Gate fee required to cover costs (EUR/tonne)					
	100 kt/yr		200 kt/yr		400 kt/yr	
	Elect.	CHP	Elect.	CHP	Elect.	CHP
Pool price (EUR 0.04/kWh)	75.2	83.2	57.6	64	44.8	49.6
(EUR 0.064/kWh for 15 yr.)	65.6	75.2	48	56	36.8	41.6

**Table 10.10: UK gate fees for different incinerator capacities and energy outputs**  
[43, Eunomia, 2001]



2. another study assessed costs for plant of different sizes (110 kt/yr, 225 kt/yr, 400 kt/yr and 600 kt/yr) assuming that bottom ash (30 % input) and fly ash (4 % of input) would both be disposed of at GBP 10 per tonne, electricity (600 kWh/tonne) sold at EUR 0.048/kWh, ferrous metal sold at EUR 32 per tonne (6 kg recovered per tonne input waste), and 19 % of waste eligible for packaging recovery credit sales at EUR 24 per tonne. With a cost of capital of 15 %, gate fees to generate the required rate of return were calculated at EUR 91.2 (110 kt/yr), EUR 65.4 (225 kt/yr) and EUR 50.7 (400 kt/yr) and EUR 42.2 (600 kt/yr).

In all cases, the capital expenditures (which drive the cost side of the equation) vary significantly. What is included, and the manner in which this is accounted for varies across the studies.

An attempt to provide a more detailed breakdown was designed to illustrate sensitivities to key variables and is given below. It is reported that relative to earlier studies:

- United Kingdom incinerators will have had to improve the performance of flue-gas treatment since the days of earlier studies
- a source of revenue is now available where it was not before. Incinerators are allowed to issue PRNs in respect of the packaging content of waste recovered (which has been estimated, for the purposes of calculating the quantity of packaging recovered, at 19 % of input wastes). However, given the debates over whether this revenue will continue in the longer term, it might not be accounted for in calculations of costs by private contractors (since they may not be able to depend on this revenue over the plant's life)
- the previous regime in respect of renewable energy allowed energy from waste plants to benefit from Non-Fossil Fuel Obligation (NFFO) contracts which offered price support for electricity delivered by the plant. The new Renewables Obligation removes this possibility for incinerators (though it seems possible that pyrolysis and gasification plants will benefit from such support).

Capacity t/yr			100000	200000	Unit Costs	
Utilisation as % capacity			95 %	95 %	100000 t/yr	200000 t/yr
			95000	190000		
<b>CAPITAL EXPENDITURE</b>						
Acquisition			EUR 1120000	EUR 1920000		
Handling, furnace, civil works, gas treatment boiler and power generation			EUR 32000000	EUR 46000000		
Planning			EUR 1600000	EUR 2400000		
Project development			EUR 2696000	EUR 3896000		
Total capital expenditure			EUR 56616000	EUR 81816000		
Total capital expenditure excl. vehicles			EUR 51200000	EUR 73600000		
Annualised capital expenditure			EUR 5344149	EUR 7722851	EUR 56.26	EUR 40.64
Annualised capital expenditure excl. vehicles						
<b>OPEX</b>						
Labour			EUR 1120000	EUR 1440000	EUR 11.79	EUR 7.58
Fuel						
Electricity						
Maintenance			EUR 1024000	EUR 1472000	EUR 10.78	EUR 7.74
Other			EUR 640000	EUR 1280000	EUR 6.74	EUR 6.74
Disposal of rejects			0	0	EUR 0.00	EUR 0.00
<i>Bottom Ash</i>	12.8	0.24	EUR 291840	EUR 583680	EUR 3.07	EUR 3.07
<i>Fly Ash/APC residues</i>	88	0.044	EUR 367840	EUR 735680	EUR 3.87	EUR 3.87
Total annualised costs			EUR 8527909	EUR 12714371	EUR 92.50	EUR 69.65
<b>REVENUES</b>						
	Unit Price	Quantity per tonne				
Net energy (kWh)	0.0360	500	- EUR 1710000	- EUR 3420000	- EUR 18.00	- EUR 18.00
Material sales (Fe)	0	0.04	0	0	EUR 0.00	0.00
Packaging recovery revenues	32	0.19	- EUR 433200	- EUR 866400	- EUR 4.56	- EUR 4.56
<b>COSTS NET OF REVENUES</b>			<b>EUR 6384709</b>	<b>EUR 8427971</b>	<b>EUR 69.94</b>	<b>EUR 47.09</b>

Table 10.11: Breakdown of estimated United Kingdom incinerator costs  
Source [43, Eunomia, 2001]

- in the UK there is some uncertainty as to how implementation of the Landfill Directive will affect the costs of landfilling ash residues. In some countries increasing quantities of bottom ash are recovered for use in construction. It was assumed in earlier studies that fly ash and air pollution control would be disposed of for EUR 35 per tonne (inclusive of EUR 16 landfill tax). However, if they require stabilisation before landfilling this would increase the disposal costs of this residue. Note the breakdown assumes a cost for fly ash disposal of EUR 55 per tonne; and
- it is assumed that although steel is recovered from the plant, its quality is such that it may not attract a positive price.

#### Key factors explaining current variation in costs:

The gate fee paid by Local Authorities is strongly influenced by whether or not the Local Authority is successful in bidding for PFI (Public Finance Initiative) credits. PFI credits effectively subsidise the capital cost of incineration plants enabling local authorities to purchase them when they might otherwise be unable to do so. The plant in Table 7.12 might see its gate fee (to a Local Authority) halved under this scheme.

#### Key Factors expected to influence future costs:

The following factors may affect gate fees in future:

- incinerators currently obtain packaging recovery income for 19 % of the material combusted. Removing this option (if the recovery obligation were removed from the Packaging Directive) would increase the gate fee up by around EUR 4.8 (though future prices could make this "loss" greater or smaller)
- the Landfill Directive requires an end to co-disposal and the pretreatment of landfilled waste. United Kingdom government has yet to decide upon what the requirements for pretreatment will entail for fly ash. A requirement to solidify ash in cement or glass would increase costs by as much as EUR 38 per tonne (since the estimated treatment cost for fly ash disposal would increase by a factor of 5 – 10). Even without this, the potential scarcity of hazardous waste landfills makes it unclear where fly ash can be landfilled.

## **10.2 Economic overview – some technological aspects of MSWI**

This annex presents the supplied data concerning the costs of some MSW incineration facilities. The economic aspects of various types of MSW plants/situations are considered. These are:

- discharge and storage costs at a MSWI
- firing system and boiler selection and sizing at a MSWI
- various configurations of the water steam cycle for energy recovery at a MSWI
- selected options for flue-gas treatment at MSWI
- cost estimations for whole MSWI plants using grate technology
- costs of fluidised bed plants for MSW (including pretreatment costs)
- gasification and pyrolysis systems for MSW.

NOTE: The figures given in this annex 10.2 are to be taken as examples and estimates only. They are provided to give the reader an idea of cost structures and inter-relationships, but **MUST NOT** be taken as accurate representations. Significant variation in cost is seen from site to site. Other combinations are also possible. [64, TWGComments, 2003]

As already noted, the costs of a waste incineration plant basically depend on the following factors:

- plant design
- size
- local infrastructure
- specific boundary conditions for waste disposal
- possibility for energy utilisation.

The main components are:

- repayment of investment
- maintenance and re-investment costs
- labour costs
- other fixed costs, such as administration and insurance
- operating costs proportional to throughput, such as chemical supply and waste disposal
- revenues from energy production proportional to throughput.

### Existing Installations:

The cost of retrofitting systems at existing installations is higher than the costs at new installations. This is related to the higher cost of the technical implementation of these techniques rather than techniques themselves.

The additional factors that can further increase costs at existing installations are:

- additional engineering effort
- additional civil engineering
- cost of destruction and removal of old equipment
- connection cost
- production losses of the existing plant, etc.

These can amount to an additional cost increase of 25 – 50 %. [64, TWGComments, 2003]

### Assumptions made in the study:

In the study [3, Austria, 2002] from which this annex is drawn, the thermal output is considered the key parameter for the investment and operating costs, and not the mass throughput. The thermal output determines the size of the boiler and primarily the flue-gas volume and therefore the size of the flue-gas cleaning devices.

For a better understanding of this chapter some parameters were fixed as follows:

- calorific value of the waste: 10 MJ/kg
- ash content of the waste: 30 %
- chlorine concentration in the raw gas before flue-gas cleaning: 1000 mg/Nm<sup>3</sup>
- SO<sub>2</sub> concentration in the raw gas: 600 mg/Nm<sup>3</sup> (Note: a high assumption for MSW, normally nearer 200 mg/Nm<sup>3</sup> [64, TWGComments, 2003])
- specific air requirement per tonne waste: 4500 m<sup>3</sup>
- specific flue-gas volume after flue-gas cleaning: 5500 Nm<sup>3</sup>/tonne of waste.

To calculate the required induced draught fan power, combustion air with a temperature of 50 °C and a pressure increase of 40 mbar is taken as a basis. The fan efficiency was uniformly assumed to be 70 %.

On the basis of these assumptions, specific costs for particular plant sub-units have been estimated and are given per tonne of combusted waste. As in practise, different boundary conditions for the particular plants apply and each plant represents more or less a prototype, so only a rough estimate can be presented.

The investment costs that are described in this paper are based on order prices of the last five years (predominantly Austrian and German plants, which were constructed under comparable boundary conditions).

### 10.2.1 Discharge and storage costs for MSWI

In densely populated regions, waste is delivered to the waste incineration plants by refuse collection vehicles. There it is directly dumped into the waste bunker. Therefore, only weighing installations, traffic areas and waste bunkers have to be erected as installations for delivery and storage. The size, and consequently the costs, of these traffic areas and waste bunkers are mainly determined by the plant capacity and the storage volume of the bunker.

Primarily these costs arise from expenses for building above ground level and foundation work. In this case, the investment costs are not directly proportional to the bunker and plant sizes but have to be calculated with the exponent 0.7. For example, doubling the bunker volume will increase costs by a factor:  $\text{size}^{0.7}$  [3, Austria, 2002]

As to a plant with a yearly waste throughput of about 300000 tonnes, the construction costs for traffic areas and bunkers are about EUR 10 million. For different plant sizes, costs presented in Table 10.12 have been estimated.

Parameter	Throughput		
	100000 t/yr	200000 t/yr	300000 t/yr
Investment costs (EUR)	about 4.6 M	about 7.5 M	about 10 M
Specific investment costs (EUR/t)	4.74	3.86	3.43
Specific maintenance costs (EUR/t)	0.46	0.38	0.33
<b>Specific costs for delivery with refuse collection vehicles (EUR/t)</b>	<b>5.2</b>	<b>4.24</b>	<b>3.77</b>

**Table 10.12: Specific costs for discharge and storage facilities as a function of throughput when waste is delivered by refuse collection vehicles**  
[3, Austria, 2002]

In less densely populated regions some of the waste may be delivered by train. This then makes the erection of track works and installations for discharge, such as container crane systems and dump devices, necessary. Investment cost for a complete crane system is about EUR 3.5 million (for 300000 t/yr). Crane systems for smaller plants are not much cheaper, since their costs depend on the standardised dimensions of the containers. However, costs for tracks will decrease with decreasing plant size.

For different plant sizes costs presented in Table 10.13 have been estimated. Yearly maintenance costs uniformly were rated at 3 % of investment costs.

Parameter	Throughput		
	100000 t/yr	200000 t/yr	300000 t/yr
Investment costs (EUR)	c. 3 million	about 4 M	about 5 M
Specific investment costs (EUR/t)	3.09	2.06	1.72
Specific maintenance costs (EUR/t)	0.90	0.60	0.50
<b>Specific costs of train discharge (EUR/t)</b>	<b>3.99</b>	<b>2.66</b>	<b>2.22</b>

**Table 10.13: Specific costs for discharge and storage facilities as a function of throughput when waste is delivered by train**  
[3, Austria, 2002]

If one part of the waste is delivered by train and the other part is delivered by refuse collection vehicles, overall costs have to be added

### 10.2.2 Firing system and boiler costs for MSWI

The firing system and the boiler comprises the following components:

- installation for feeding and dosing of waste
- supply of combustion air
- combustion grate with combustion chamber
- transport and storage installations for ash and slag
- flue-gas ducts until feed-water preheater
- waste heat boiler including feed-water supply and fresh steam delivery.

Cost determining factors for the firing system and the boiler are:

- the type of the grate system
- the desired boiler efficiency and
- the design of the waste heat boiler.

If water-cooled grates are installed and the flue-gas temperature after the waste heat boiler is 160 °C (which increases boiler efficiency to 90 %) and if high steam parameters are applied, the average investment costs can be up to 20 % higher.

For a line with a yearly throughput of about 150000 tonnes, investment costs for the firing system and the boiler without costs for construction and for electronic, monitoring, regulation and control equipment are about EUR 16 million. Costs for heating surfaces are proportional to the size of the plant, whereas costs for other equipment depend on the plant size, so that on average investment costs will depend on size by a factor of about size<sup>0.8</sup>. [3, Austria, 2002]

Thus for different plant sizes specific costs shown in Table 10.14 below have been estimated. Costs are generally independent of the number of combustion lines.

Parameter	Throughput		
	75000 t/yr	100000 t/yr	150000 t/yr
Investment costs (EUR)	c. 9.2 million	c. 11.6 million	c. 16 million
Specific investment costs (EUR/yr)	12.63	11.94	10.98
Yearly maintenance costs in per cent of investment costs (%/yr)	4.00	4.00	4.00
Specific maintenance costs (EUR/yr)	4.90	4.60	4.30
Average overall consumption of electricity (normal operation) (kWh/t)	27	27	27
Costs of electricity (EUR/t)	0.67	0.67	0.67
Accumulating bottom ash and boiler ash (kg/t)	271.50	271.50	271.50
Disposal costs of bottom ash and boiler ash (EUR/t)	19.16	19.16	19.16
<b>Specific costs for firing and boiler (EUR/t)</b>	<b>37.37</b>	<b>36.42</b>	<b>35.08</b>

**Table 10.14: Specific costs for a grate firing system and the boiler of waste incineration plants as a function of throughput**  
[43, Eunomia, 2001] [3, Austria, 2002]

Operating costs for the firing system that are directly proportional to the waste throughput arise from:

- energy consumption for air and flue-gas conveying and for feed-water supply
- disposal/recycling costs for bottom ash.

The specific energy consumption for the firing system and the boiler is about 27 kWh/t at a steam pressure of about 50 bar. If the steam pressure is increased to 75 bar the energy demand will rise by about 4 kWh/t.

As to the disposal costs for bottom ash it was assumed that both can be disposed of on a landfill for residual waste. If boiler ash could not, and was disposed of underground, disposal costs would rise by about EUR 2/t.

About 3.2 tonnes of steam per tonne waste are produced in general. Proceeds from steam production are outlined in Section 10.2.3 on the water-steam cycle.

### 10.2.3 Water-steam cycle costs for MSWI

The water-steam cycle of a waste incineration plant comprises the following components: water treatment plant, condensate system, turbine with cooling system and heat decoupling system.

Different systems are installed in waste incineration plants. At some plants the major part of the energy is fed into the district heating network and electricity is only produced to cover their own needs. At other plants, emphasis is placed on the production of electricity. The kind of plant and the possibilities for energy delivery primarily determine the proceeds from energy production. Therefore this cost overview is presented in such a way that energy proceeds can be totally attributed to the water-steam cycle. Therefore, five technical systems have been distinguished. The energy yield attained in practise depends on a great number of parameters such as boiler design, heat-exchanger surfaces, utilisation of low pressure steam for feed-water and air preheating and turbine design.

In the following section a comparison of different systems shall be made under standardised boundary conditions.

The main cost factors of the water-steam cycle are described on the basis of the following assumptions:

- yearly operating hours: 7500 h
- in every case a boiler efficiency of about 80 % is assumed so that an energy output of 2.2 MWh per tonne waste results (calorific value of the waste: 10 MJ/kg). This value can vary by plus/minus 10 % depending on the plant
- the investment costs were derived from that of comparable plants. Depending on the actual boundary conditions, significant deviations may occur
- the specific investment costs were calculated on the basis of a rate of interest of 6 % over a duration of 15 years. This period was chosen as the probability for re-investment costs are high after 15 years operation
- yearly maintenance costs uniformly were rated at 3 % of investment costs
- heat and electricity delivery were adjusted to the steam parameters. Depending on the type of turbine and the type and operation of the water-steam cycle deviations may occur
- the use of assumed steam pressures of 50 Bar and 80 Bar is higher than the 40 Bar standard commonly used at many MSWI plants, to avoid corrosion without requiring special measures
- proceeds from delivered energy mainly depend on the kind of energy and the particular energy demand. For feeding electricity into the grid, normally a price of c. EUR 25 per MWh (selling price) is paid. For feeding heat into the district heating system, c. EUR 6 per MWh is paid. If the plant is situated at a site where a demand for electricity and heat exists, the income can be about EUR 45 per MWh (purchase price) for electricity and about EUR 10 per MWh for heat. Consequently for the options EUR 1 - 25 per MWh for electricity and EUR 6 per MWh for heat delivery were taken as relevant values. In comparison, EUR 45 per MWh for electricity and EUR 10 per MWh for heat delivery are paid for options 6, 7 and 8. Option 6 technically corresponds to option 2, option 7 technically corresponds to option 4 and option 8 technically corresponds to option 5.

**Option 1: Pure heat decoupling:**

If only heat is produced, the investment costs comprise expenses for water, condensate treatment and for heat transformation. If no other infrastructure exists, cooling systems for emergency situations have to be installed.

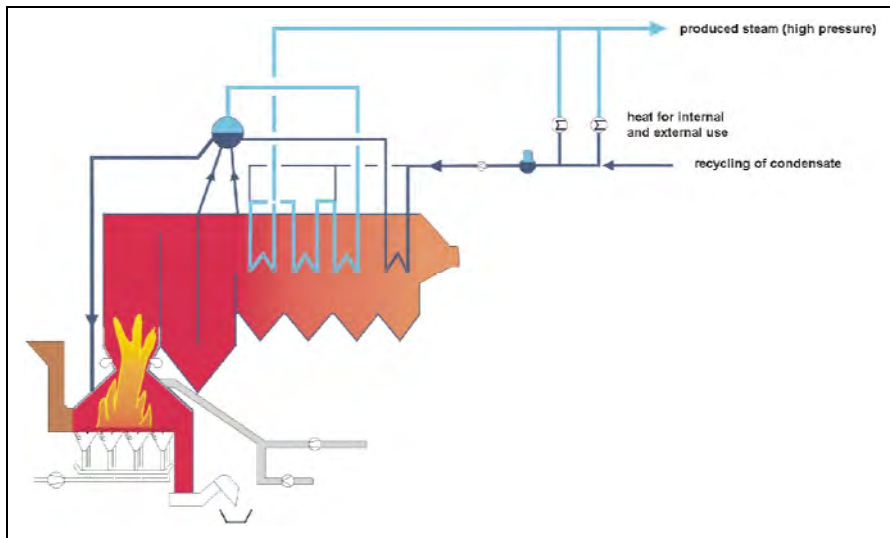

**Figure 10.1: Water-steam cycle, option 1**  
[3, Austria, 2002]

Parameter	Throughput		
	100000 t/yr	200000 t/yr	300000 t/yr
Investment costs (EUR)	c. 3 million	c. 4.5 million	c. 6 million
Specific investment costs (EUR/t)	3.09	2.32	2.06
Specific maintenance costs (EUR/t)	0.90	0.68	0.60
Heat delivery (MWh t <sup>-1</sup> )	2.2	2.2	2.2
Specific proceeds from heat production (EUR/t)	13.2	13.2	13.2
<b>Rated proceeds from water-steam cycle (EUR/t)</b>	<b>9.21</b>	<b>10.21</b>	<b>10.54</b>

**Table 10.15: Specific costs of a water-steam cycle with pure heat decoupling and feeding into district heating systems as a function of waste throughput**  
Source [3, Austria, 2002]

**Option 2: Steam extraction turbine applying steam parameters of 50 bar and 400 °C:**

In this case investment costs comprise costs for water and condensate treatment, for heat decoupling, and for the turbine and cooling systems. If no other infrastructure exists re-cooling systems for emergency situations also need to be installed (Figure 10.2).



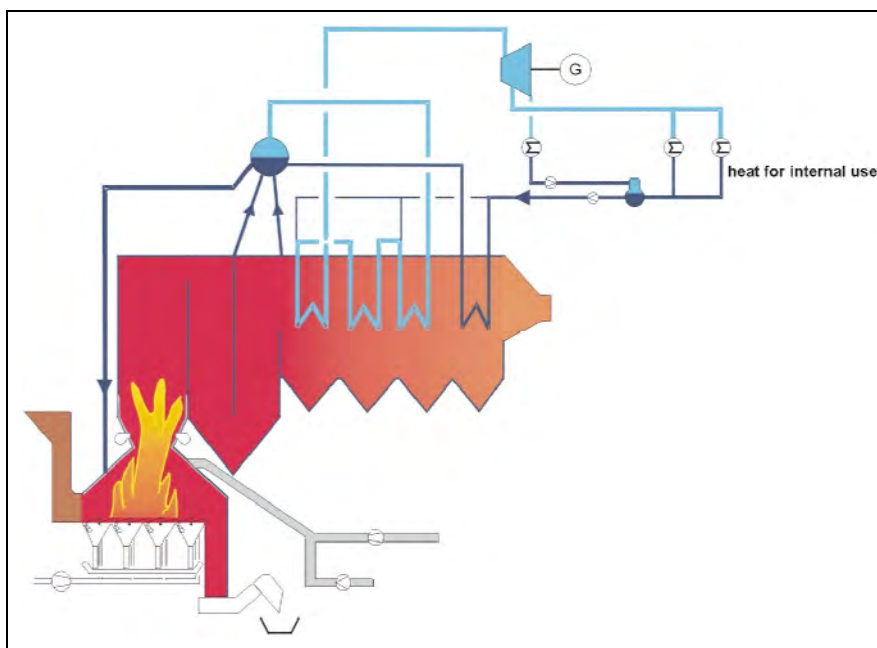

Figure 10.2: Water-steam cycle, option 2 and 6  
[3, Austria, 2002]

Parameter	Throughput		
	100000 t/yr	200000 t/yr	300000 t/yr
Investment costs (EUR)	c. 8 million	c. 12 million	c. 16 million
Specific investment costs (EUR/t)	8.24	6.18	5.49
Specific maintenance costs (EUR/t)	2.40	1.80	1.60
Heat delivery (MWh t <sup>-1</sup> )	0	0	0
Specific proceeds from heat production (EUR/t)	0	0	0
Electricity delivery (MWh t <sup>-1</sup> )	0.44	0.44	0.44
Specific proceeds from electricity production (EUR/t)	11	11	11
<b>Rated proceeds from water-steam cycle (EUR/t)</b>	<b>0.36</b>	<b>3.02</b>	<b>3.91</b>

Table 10.16: Specific costs of a water-steam cycle comprising a steam extraction turbine as a function of waste throughput  
[3, Austria, 2002]

**Option 3: Steam extraction turbine combined with steam introduction into an adjacent thermal power plant:**

In addition to the investment costs given in option 2, the costs for retrofit measures in the power plant, minus the existent infrastructure, have to be considered (Figure 10.3).

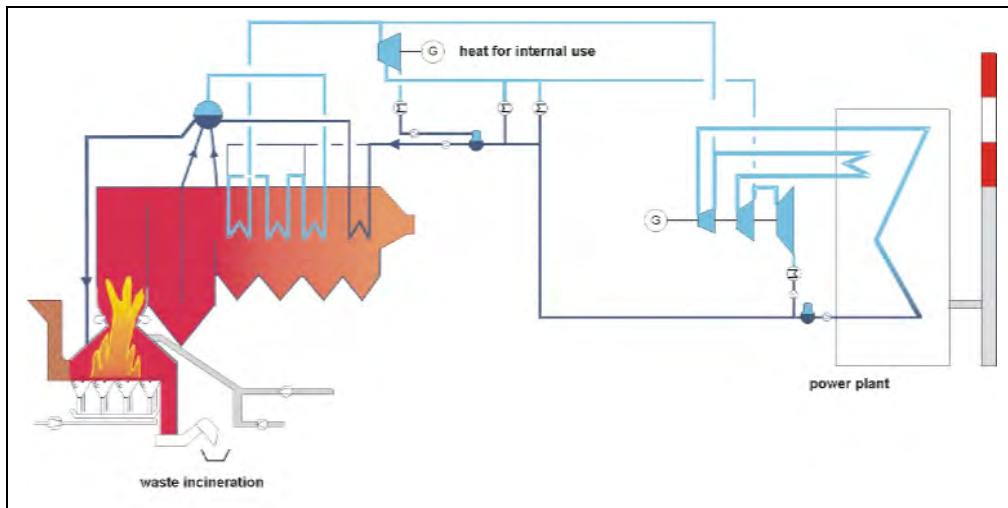

Figure 10.3: Water-steam cycle, option 3  
[3, Austria, 2002]

Parameter	Throughput		
	100000 t/yr	200000 t/yr	300000 t/yr
Investment costs (EUR)	c. 8.5 million	c. 12.5 million	c. 15 million
Specific investment costs (EUR/t)	8.75	6.44	5.15
Specific maintenance costs (EUR/t)	2.55	1.88	1.50
Heat delivery (MWh t <sup>-1</sup> )	0	0	0
Specific proceeds from heat production (EUR/t)	0	0	0
Electricity delivery (MWh t <sup>-1</sup> )	0.66	0.66	0.66
Specific proceeds from electricity production (EUR/t)	16.5	16.5	16.5
<b>Rated proceeds from water-steam cycle (EUR/t)</b>	<b>5.20</b>	<b>8.19</b>	<b>9.85</b>

Table 10.17: Specific costs of a water-steam cycle comprising a steam extraction turbine in combination with the steam system of an adjacent power plant as a function of waste throughput [3, Austria, 2002]

#### **Option 4: Cogeneration (CHP) applying steam parameters of 50 bar and 400 °C:**

In addition to the investment costs given in option 2 the costs for a heat decoupling system needs to be considered (Figure 10.4).

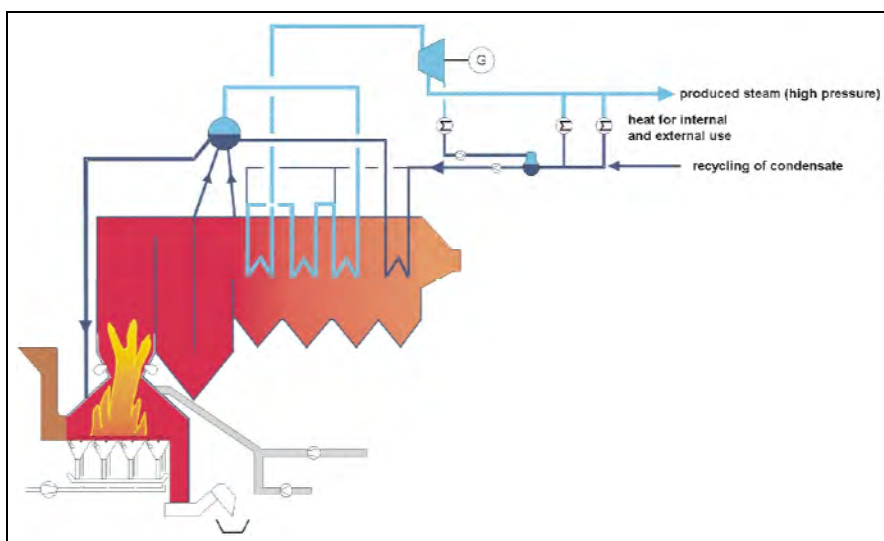

Figure 10.4: Water-steam cycle, options 4, 5, 7 and 8  
[3, Austria, 2002]

Parameter	Throughput		
	100000 t/yr	200000 t/yr	300000 t/yr
Investment costs (EUR)	c. 9 million	c. 14 million	c. 18 million
Specific investment costs (EUR/t)	9.27	7.21	6.18
Specific maintenance costs (EUR/t)	2.70	2.10	1.80
Heat delivery (MWh t <sup>-1</sup> )	1.98	1.98	1.98
Specific proceeds from heat production (EUR/t)	11.88	11.88	11.88
Electricity delivery (MWh t <sup>-1</sup> )	0.22	0.22	0.22
Specific proceeds from electricity production (EUR/t)	5.50	5.50	5.50
<b>Rated proceeds from water-steam cycle (EUR/t)</b>	<b>5.41</b>	<b>8.07</b>	<b>9.40</b>

**Table 10.18: Specific costs of a water-steam cycle comprising cogeneration (CHP) and low steam parameters as a function of waste throughput**

Source [3, Austria, 2002]

#### **Option 5: Cogeneration (CHP) applying steam parameters of 80 bar and 500 °C:**

In addition to the investment costs given in option 2, the cost increases for raised steam parameters and costs for the installations for heat decoupling have to be considered.

Parameter	Throughput		
	100000 t/yr	200000 t/yr	300000 t/yr
Investment costs (EUR)	c. 10 million	c. 15.5 million	c. 20 million
Specific investment costs (EUR/t)	10.30	7.98	6.86
Specific maintenance costs (EUR/t)	3.00	2.33	2.00
Heat delivery (MWh t <sup>-1</sup> )	1.87	1.87	1.87
Specific proceeds from heat production (EUR/t)	11.22	11.22	11.22
Electricity delivery (MWh t <sup>-1</sup> )	0.33	0.33	0.33
Specific proceeds from electricity production (EUR/t)	8.25	8.25	8.25
<b>Rated proceeds from water-steam cycle (EUR/t)</b>	<b>6.17</b>	<b>9.17</b>	<b>10.61</b>

**Table 10.19: Specific costs of a water-steam cycle comprising cogeneration (CHP) and high steam parameters as a function of waste throughput**

[3, Austria, 2002]

#### **Option 6: Steam extraction turbine applying steam parameters of 50 bar and 400 °C:**

Contrary to option 2, the waste incineration plant is located at a site where energy can be substituted which would otherwise have to be purchased.

Parameter	Throughput		
	100000 t/yr	200000 t/yr	300000 t/yr
Investment costs (EUR)	c. 8 million	c. 12 million	c. 16 million
Specific investment costs (EUR/t)	8.24	6.18	5.49
Specific maintenance costs (EUR/t)	2.40	1.80	1.60
Heat delivery (MWh t <sup>-1</sup> )	0	0	0
Specific proceeds from heat production (EUR/t)	0	0	0
Electricity delivery (MWh t <sup>-1</sup> )	0.44	0.44	0.44
Specific proceeds from electricity production (EUR/t)	19.8	19.8	19.8
<b>Rated proceeds from water-steam cycle (EUR/t)</b>	<b>9.16</b>	<b>11.82</b>	<b>12.71</b>

**Table 10.20: Specific costs of a water-steam cycle comprising a steam extraction turbine (normal steam parameters) as a function of waste throughput when energy can be substituted**

[3, Austria, 2002]

**Option 7: Cogeneration (CHP) applying steam parameters of 50 bar and 400 °C:**

Contrary to option 4, the waste incineration plant is in this case located at a site where energy can be substituted which would otherwise have to be purchased.

Parameter	Throughput		
	100000 t/yr	200000 t/yr	300000 t/yr
Investment costs (EUR)	c. 9 million	c. 14 million	c. 18 million
Specific investment costs (EUR/t)	9.27	7.21	6.18
Specific maintenance costs (EUR/t)	2.70	2.10	1.80
Heat delivery (MWh t <sup>-1</sup> )	1.98	1.98	1.98
Specific proceeds from heat production (EUR/t)	19.80	19.80	19.80
Electricity delivery (MWh t <sup>-1</sup> )	0.22	0.22	0.22
Specific proceeds from electricity production (EUR/t)	9.90	9.90	9.90
<b>Rated proceeds from water-steam cycle (EUR/t)</b>	<b>17.73</b>	<b>20.39</b>	<b>21.72</b>

**Table 10.21: Specific costs of a water-steam cycle comprising cogeneration (CHP - normal steam parameters) as a function of waste throughput when energy can be substituted [3, Austria, 2002]**

**Option 8: Cogeneration (CHP) applying steam parameters of 80 bar and 500 °C:**

Contrary to option 5, the waste incineration plant is in this case located at a site where energy can be substituted which would otherwise have to be purchased.

Parameter	Throughput		
	100000 t/yr	200000 t/yr	300000 t/yr
Investment costs (EUR)	c. 10 million	c.15.5 million	c. 20 million
Specific investment costs (EUR/t)	10.30	7.98	6.86
Specific maintenance costs (EUR/t)	3.00	2.33	2.00
Heat delivery (MWh t <sup>-1</sup> )	1.87	1.87	1.87
Specific proceeds from heat production (EUR/t)	18.70	18.70	18.70
Electricity delivery (MWh t <sup>-1</sup> )	0.33	0.33	0.33
Specific proceeds from electricity production (EUR/t)	14.85	14.85	14.85
<b>Rated proceeds from water-steam cycle (EUR/t)</b>	<b>20.25</b>	<b>23.25</b>	<b>24.69</b>

**Table 10.22: Specific costs of a water-steam cycle comprising cogeneration (CHP - high steam parameters) as a function of waste throughput when energy can be substituted Source [3, Austria, 2002]**

## **Discussion of water-steam cycle options 1 to 8:**

### **Survey of specific proceeds from water-steam**

Option	Variation in income in EUR per tonne of waste treated with option and throughput		
	100000 t/yr	200000 t/yr	300000 t/yr
Option 1	9.21	10.21	10.54
Option 2	0.36	3.02	3.91
Option 3	5.20	8.19	9.85
Option 4	5.41	8.07	9.40
Option 5	6.17	9.17	10.61
Option 6	9.16	11.82	12.71
Option 7	17.73	20.39	21.72
Option 8	20.25	23.25	24.69

**Table 10.23: Survey of specific income from different options of the water-steam cycle as a function of waste throughput [3, Austria, 2002]**

As shown in Table 10.23, increasing plant size results in higher proceeds from the water-steam cycle. For lower investments (pure heat decoupling - option 1), the dependence on the plant size is only marginal.

On the basis of rated costs, higher investments for a higher rate of electricity production, as is assumed in option 3 and 5 would be economically favourable. However, option 3 can only be realised at a site adjacent to a power plant with an approximately ten times higher thermal output and a yearly operating time of at least 5000 h.

Option 5 is problematic in so far as corrosion problems occur when increased steam parameters are applied. In Table 10.23 a high availability is assumed for all options, although this is not expected in practice in the case of option 5. Here higher revision costs within the boiler system and additional downtime have to be considered. If these facts cause additional expenses of about EUR 2 million per year, specific costs will increase by EUR 7 per tonne in the case of a plant with a waste throughput of 300000 t/yr.

The difference between sites with and without heat, demand at the same cost levels for energy (option 2 and 4) referred to a throughput of 300000 tonnes per year is only about EUR 5.5/t.

Proceeds from electricity production in a power plant and co-generation (CHP) are similar.

A significant increase of proceeds may be achieved by a suitable choice of plant location if produced energy can be used or if an existing energy demand can be covered (option 6 to 8).

### **10.2.4 Costs for some flue-gas treatment combinations used in MSWI**

The economics of the process units that differentiate the following combinations of flue-gas cleaning technologies, are considered in this section. Information is taken from [3, Austria, 2002]:

#### Combination 1:

- electrostatic precipitator
- two-stage wet scrubbing with and without precipitation
- wet removal of fine dust, and
- catalytic plant (low-dust circuit).

Combination 2:

- fabric filter with dosage of lime and activated coke
- two-stage wet scrubbing with gypsum scrubber and
- downstream catalytic plant (low-dust circuit).

Combination 3:

- electrostatic precipitator
- two-stage wet scrubbing with NaOH scrubber
- fabric filter with dosage of lime and activated coke and
- downstream catalytic plant (low-dust circuit).

Combination 4:

- electrostatic precipitator
- two-stage wet scrubbing with precipitation
- activated coke absorber (cross current)
- downstream catalytic plant (low-dust circuit).

Combination 5:

- electrostatic precipitator
- two-stage wet scrubber
- wet removal of fine dust and
- activated coke absorber (countercurrent).

Combination 6:

- fluidised bed process
- fabric filter
- activated coke filter
- selective catalytic reduction.

#### **10.2.4.1 Dry flue-gas cleaning**

For dry flue-gas cleaning it is assumed that the dust concentration in the raw gas is 5 g/Nm<sup>3</sup> and that the flue-gas volume is 5500 Nm<sup>3</sup>/t.

The investment costs for the dedusting device include expenses for the filter itself, as well as for the silos, dust conveyors and dosing devices (if installed).

Operating costs mainly consist of costs for electricity consumption, disposal costs for the separated dust and costs for the adsorption reagents. Costs for the adsorption media also include disposal costs of accumulated waste.

In this assessment dedusting with an electrostatic precipitator is used in combination with a downstream wet electrostatic precipitator or a downstream activated coke plant.

The typical operational temperature range of an electrostatic precipitator is 180 – 230 °C. Specific costs of an electrostatic precipitator as a function of waste throughput are presented in Table 10.24, and the specific costs of wet de-dusting systems are shown in Table 10.25.

### Costs for dedusting with ESP

Parameter	Unit	Throughput per line		
		75000 t/yr	100000 t/yr	150000 t/yr
<b>Consumption of electricity</b>				
Specific consumption	kWh/t	12	12	12
Specific costs of energy consumption	EUR/t	0.29	0.29	0.29
<b>Disposal costs</b>				
Specific amount of accumulated waste	kg/t	27.50	27.50	27.50
Specific costs for waste disposal	EUR/t	4.13	4.13	4.13
<b>Maintenance and wear</b>				
Share of investment costs	%	2	2	2
Specific costs of maintenance	EUR/t	0.27	0.24	0.21
<b>Investment costs</b>				
Specific investment costs	EUR	1000000	1200000	1600000
Rated specific overall costs	EUR/t	<b>6.06</b>	<b>5.89</b>	<b>5.73</b>

**Table 10.24: Specific costs for dedusting with an electrostatic precipitator as a function of waste throughput**  
[3, Austria, 2002]

### Costs for a wet dedusting system

Parameter	Unit	Throughput per line		
		75000 t/yr	100000 t/yr	150000 t/yr
<b>Consumption of electricity</b>				
Average overall consumption (normal operation)	kWh/t	6	6	6
Costs of electricity consumption	EUR/t	0.16	0.16	0.16
<b>Disposal costs</b>				
Specific amount of accumulated waste	kg/t			
Specific costs for waste disposal	EUR/t			
<b>Maintenance and wear</b>				
Share of investment costs	%	1.5	1.5	1.5
Specific costs of maintenance	EUR/t	0.30	0.30	0.25
<b>Investment costs</b>				
Specific investment costs	EUR	1500000	2000000	2500000
Rated specific overall costs	EUR/t	<b>2.52</b>	<b>2.52</b>	<b>2.12</b>

**Table 10.25: Specific costs for wet dedusting as a function of waste throughput**  
[3, Austria, 2002]

It has been shown that a dry flue-gas cleaning system with dosage of activated coke is the most cost-effective solution for pre-separation of mercury, PCDD/F and for dedusting. Another advantage of this process is that a large proportion of the heavy metals and dioxins and furans are already removed before the flue-gas enters the wet scrubbing system. For that reason the pollutant concentration in the accumulated gypsum is low.

### Dry flue-gas cleaning with fabric filter

Parameter	Units	Throughput		
		75000 t/yr	100000 t/yr	150000 t/yr
<b>Consumption of electricity</b>				
Specific consumption	kWh/t	9	9	9
Specific costs of energy consumption	EUR/t	0.22	0.22	0.22
<b>CaO-consumption incl. waste disposal</b>				
Specific consumption	kg/t	0.00	0.00	0.00
Stoichiometric factor		3	3	3
Specific costs for adsorption	EUR/t	0.00	0.00	0.00
<b>Activated coke consumption</b>				
Specific consumption	kg/t	1.00	1.00	1.00
Specific costs of activated coke	EUR/t	0.30	0.30	0.30
<b>Disposal costs</b>				
Specific amount of accumulated waste	kg/t	28.50	28.50	28.50
Specific costs for waste disposal	EUR/t	4.28	4.28	4.28
<b>Maintenance and wear</b>				
Share of investment costs	%	1	1	1
Specific costs of maintenance	EUR/t	0.15	0.15	0.13
Specific costs of filter wear	EUR/t	0.78	0.78	0.78
<b>Investment costs</b>				
Specific investment costs	EUR	1150000	1450000	2000000
Rated specific overall costs	EUR/t	<b>7.30</b>	<b>7.21</b>	<b>7.08</b>

**Table 10.26: Specific costs of a dry flue-gas cleaning system with fabric filters as a function of waste throughput**  
[3, Austria, 2002]

#### 10.2.4.2 Absorption and adsorption plants for the separation of HCl, HF and SO<sub>2</sub>

In the study from which this information is drawn [3, Austria, 2002] only wet processes are mainly used for separation of HCl, HF and SO<sub>2</sub>. Data for one plant using a dry system for pre-separation is also given.

In cases where wet processes are applied, operating costs are influenced by the type and amount of adsorption media, by the energy consumption and by disposal costs for the waste. The investment costs for flue-gas ducts, scrubbers, droplet separators, heat-exchangers and reactors and for the whole infrastructure for handling of water, waste water, chemicals and residues are also included.

Assumptions made, are that 600 mg/Nm<sup>3</sup> SO<sub>2</sub> and 1000 mg/Nm<sup>3</sup> HCl have to be separated from the raw gas. Under these conditions specific costs of a NaOH scrubber are about EUR 11/t, costs of scrubbers with precipitation are between 8 and 9 EUR/t and costs of a gypsum scrubber are between EUR 5 and 6/t, respectively.

The combination of a gypsum scrubber with a dry flue-gas cleaning system with activated coke adsorption is slightly more expensive than a dry plant for the separation of HCl, HF and SO<sub>2</sub> only (13.19 vs. 12.78 EUR/t) based on a throughput of 75000 t/yr.

For plants with a waste throughput of about 100000 t/yr per line, costs are approximately the same (EUR 12.69 vs. 12.63/t). For a throughput of about 150000 t/yr per line, lower costs arise for the combination gypsum scrubber plus dry flue-gas cleaning system compared to dry adsorption only (EUR 12.15 vs. 12.44/t).



Some costs of absorption and adsorption plants are given in the tables below:

### Dry flue-gas cleaning with adsorption

Parameter	Units	Throughput per line		
		75000 t/yr	100000 t/yr	150000 t/yr
<b>Consumption of electricity</b>				
Specific consumption	kWh/t	13	13	13
Specific costs of energy consumption	EUR/t	0.33	0.33	0.33
<b>CaO-consumption incl. waste disposal</b>				
Specific consumption	kg/t	14.44	14.44	14.44
Stoichiometric factor		1.50	1.50	1.50
Specific costs for adsorption	EUR/t	4.50	4.50	4.50
<b>Activated coke consumption</b>				
Specific consumption	kg/t	1.00	1.00	1.00
Specific costs of activated coke	EUR/t	0.30	0.30	0.30
<b>Disposal costs</b>				
Specific amount of accumulated waste	kg/t	28.50	28.50	28.50
Specific costs for waste disposal	EUR/t	4.28	4.28	4.28
<b>Maintenance and wear</b>				
Share of investment costs	%	1	1	1
Specific costs of maintenance	EUR/t	0.23	0.22	0.20
Specific costs of filter wear	EUR/t	0.78	0.78	0.78
<b>Investment costs</b>				
Specific investment costs	EUR	1725000	2175000	3000000
Specific investment costs	EUR/t	2.37	2.24	2.06
<b>Rated specific overall costs</b>	<b>EUR/t</b>	<b>12.78</b>	<b>12.63</b>	<b>12.44</b>

**Table 10.27: Specific costs of a dry flue-gas cleaning system with adsorption as a function of waste throughput**  
[3, Austria, 2002]

### Gypsum scrubber

Parameter	Units	Throughput per line		
		75000 t/yr	100000 t/yr	150000 t/yr
<b>Consumption of electricity</b>				
Specific consumption	kWh/t	19	19	19
Specific costs of energy consumption	EUR/t	0.48	0.48	0.48
<b>Reheating</b>				
Temperature increase	°C	30	30	30
Heat demand	kWh/t	0.06	0.06	0.06
Specific costs	EUR/t	0.39	0.39	0.39
<b>CaCO<sub>3</sub> consumption</b>				
Specific consumption	kg/t	11.42	11.42	11.42
<b>CaO-consumption</b>				
Specific consumption	kg/t	1.89	1.89	1.89
Costs of neutralising agent	EUR/t	0.47	0.47	0.47
<b>Disposal costs</b>				
Specific amount of accumulated gypsum	kg/t	14.78	14.78	14.78
Specific amount of filter cake	kg/t	1.00	1.00	1.00
Specific costs	EUR/t	0.45	0.45	0.45
<b>Maintenance and wear</b>				
Share of investment costs	%	2	2	2
Specific costs	EUR/t	0.67	0.60	0.53
<b>Investment costs</b>				
Specific investment costs	EUR	2500000	3000000	4000000
Specific investment costs	EUR/t	3.43	3.09	2.75
<b>Rated specific overall costs</b>	<b>EUR/t</b>	<b>5.89</b>	<b>5.48</b>	<b>5.07</b>

**Table 10.28: Specific costs of a gypsum scrubber as a function of waste throughput**  
[3, Austria, 2002]

## Scrubber with precipitation

Parameter	Units	Throughput		
		75000 t/yr	100000 t/yr	150000 t/yr
<b>Consumption of electricity</b>				
Specific consumption	kWh/t	19	19	19
Specific costs of energy consumption	EUR/t	0.48	0.48	0.48
<b>Reheating</b>				
Temperature increase	°C	30	30	30
Heat demand	kWh/t	0.06	0.06	0.06
Specific costs	EUR/t	0.39	0.39	0.39
<b>NaOH- consumption</b>				
Specific consumption	kg/t	2.75	2.75	2.75
<b>CaO-consumption</b>				
Specific consumption	kg/t	9.87	9.87	9.87
Costs neutralising of agent	EUR/t	2.07	2.07	2.07
<b>Disposal costs</b>				
Specific amount of accumulated gypsum	kg/t	8.87	8.87	8.87
Specific amount of filter cake	kg/t	10.85	10.85	10.85
Specific costs	EUR/t	2.16	2.16	2.16
<b>Maintenance and wear</b>				
Share of investment costs	%	2	2	2
Specific costs	EUR/t	0.67	0.60	0.53
<b>Investment costs</b>				
Specific investment costs	EUR/t	3.43	3.09	2.75
<b>Rated specific overall costs</b>	<b>EUR/t</b>	<b>9.19</b>	<b>8.78</b>	<b>8.37</b>

Table 10.29: Specific costs of a scrubber with precipitation as a function of waste throughput  
Source [3, Austria, 2002]

## 10.2.4.3 NaOH scrubber

Parameter	Units	Throughput per line		
		75000 t/yr	100000 t/yr	150000 t/yr
<b>Consumption of electricity</b>				
Specific consumption	kWh/t	19	19	19
Specific costs of energy consumption	EUR/t	0.48	0.48	0.48
<b>Reheating</b>				
Temperature increase	°C	30	30	30
Heat demand	MWh/t	0.06	0.06	0.06
Specific costs	EUR/t	0.39	0.39	0.39
<b>NaOH- consumption</b>				
Specific consumption	kg/t	6.88	6.88	6.88
<b>CaO-consumption</b>				
Specific consumption	kg/t	4.71	4.71	4.71
Costs for neutralising agent	EUR/t	3.77	3.77	3.77
<b>Disposal costs</b>				
Specific amount of accumulated gypsum	kg/t	0.00	1.00	2.00
Specific amount of filter cake	kg/t	25.64	25.64	25.64
Specific costs	EUR/t	3.85	3.91	3.97
<b>Maintenance and wear</b>				
Share of investment costs	%	1.5	1.5	1.5
Specific costs	EUR/t	0.36	0.33	0.30
<b>Investment costs</b>				
Specific investment costs	EUR/t	2.47	2.27	2.06
<b>Rated specific overall costs</b>	<b>EUR/t</b>	<b>11.31</b>	<b>11.14</b>	<b>10.96</b>

Table 10.30: Specific costs of a NaOH scrubber as a function of waste throughput  
[3, Austria, 2002]

#### 10.2.4.4 Secondary NO<sub>x</sub> reduction using SCR or SNCR

[3, Austria, 2002]

In addition to investment costs and costs for SCR commonly include: maintenance, flue-gas reheating, catalyst-exchange, ammonia/urea and electricity. Flue-gas reheating costs are dependent on catalyst operation temperature and the order in which flue-gas treatment techniques are applied i.e. if wet scrubbers are applied downstream of SCR systems, the inlet temperature to the SCR preheater can be lower and hence less reheat required. Application of SCR in high dust areas is rare in waste incineration facilities (for operational reasons) but has the advantage of avoiding reheating.

Included in the investment costs presented here are; the whole flue-gas path with heat transfer system, flue-gas pipe, catalyst box and bypass pipe as well as the whole NH<sub>4</sub>OH system consisting of de-tanking equipment, storage, dosing station, evaporation and mixing. The overall costs of catalytic flue-gas cleaning (Table 10.31) are about 3 EUR/t, which is two times higher than the costs for non-catalytic flue-gas cleaning (SNCR see Table 10.32).

SCR is generally used where emission limits are set below 100 mg/Nm<sup>3</sup> and gives performance typically in the range of 40 – 70 mg/Nm<sup>3</sup>. Although emission concentrations below 70 mg/Nm<sup>3</sup> are reported in some cases, SNCR emission levels in the range of 120 – 180 mg/Nm<sup>3</sup> are more typical.

If the catalyst is also used for dioxin oxidation the catalyst volume and thus the position specific volume/catalyst wear will increase. However, the differences in overall costs are small.

##### Catalytic flue-gas cleaning (SCR)

Parameter	Units	Throughput per line		
		75000 t/yr	100000 t/yr	150000 t/yr
<b>Consumption of electricity</b>				
Specific consumption	kWh/t	8	8	8
Specific costs of energy consumption	EUR/t	0.20	0.20	0.20
<b>Reheating</b>				
Temperature increase	°C	30	30	30
Heat demand	MWh/t	0.06	0.06	0.06
Specific costs	EUR/t	0.64	0.64	0.64
<b>NH<sub>4</sub>OH consumption (as NH<sub>3</sub> solution 25 %)</b>				
Specific consumption	kg/t	2.44	2.44	2.44
Specific costs	EUR/t	0.37	0.37	0.37
<b>Maintenance and wear</b>				
Share of investment costs	%	1	1	1
Specific	EUR/t	0.16	0.15	0.13
Average life cycle	a	10.00	10.00	10.00
Specific costs catalyst wear	EUR/t	0.30	0.30	0.30
<b>Investment costs</b>				
Specific investment costs	EUR/t	1.65	1.54	1.37
<b>Rated specific overall costs</b>	<b>EUR/t</b>	<b>3.32</b>	<b>3.20</b>	<b>3.02</b>

**Table 10.31: Specific costs of SCR as a function of waste throughput**  
[3, Austria, 2002]

Note: Several members of the TWG commented that the SCR investment cost presented above were low compared to the current market.

**Non-catalytic flue-gas cleaning (SNCR)**

Parameter	Units	Throughput per line		
		75000 t/yr	100000 t/yr	150000 t/yr
<b>Consumption of electricity</b>				
Specific consumption	kWh/t	2	2	2
Specific costs of energy consumption	EUR/t	0.04	0.04	0.04
<b>NH<sub>4</sub>OH consumption (as NH<sub>3</sub> solution 25 %)</b>				
Specific consumption	kg/h	4.88	4.88	4.88
Specific costs	EUR/t	0.73	0.73	0.73
<b>Maintenance and wear</b>				
Share of investment costs	%	2	2	2
Specific	EUR/t	0.19	0.16	0.13
<b>Investment costs</b>				
Specific investment costs	EUR/t	0.96	0.82	0.69
<b>Rated specific overall costs</b>	<b>EUR/t</b>	<b>1.92</b>	<b>1.76</b>	<b>1.59</b>

**Table 10.32: Specific costs of SNCR as a function of waste throughput**  
[3, Austria, 2002]

**10.2.4.5 Post treatment flue-gas polishing systems**

At some plants, systems for the post treatment of flue-gases are installed after the dedusting and gas absorption or adsorption operations: These are generally a flow injection absorber (Table 10.33) with activated coke and lime or limestone as reagents and fixed bed absorber (Table 10.34) using furnace coke.

In this case, reacted or loaded reagents are returned in the combustion system. Thus operating costs are primarily the costs for the adsorption media and electricity consumption. Investment costs include flue-gas ducts, heat-exchangers, reactors and filters and the required infrastructure for delivery, storage and dosage of chemicals and for conveying, storage and landfilling of residues.

The costs of an additional flue-gas polishing stages are given below:

**Flow injection absorber**

Parameter	Units	Throughput per line		
		75000 t/yr	100000 t/yr	150000 t/yr
<b>Consumption of electricity</b>				
Specific consumption	kWh/t	9	9	9
Specific costs of energy consumption	EUR/t	0.22	0.22	0.22
<b>CaO-consumption incl. salt disposal</b>				
Specific consumption	kg/t	4.77	4.77	4.77
Stoichiometric factor		15.00	15.00	15.00
Specific costs for adsorption	EUR/t	1.09	1.09	1.09
<b>Activated coke consumption</b>				
Specific consumption	kg/t	1.00	1.00	1.00
Specific costs of activated coke	EUR/t	0.30	0.30	0.30
<b>Disposal costs</b>				
Specific amount of accumulated waste	kg/t	1.06	1.06	1.06
Specific costs for waste disposal	EUR/t	0.16	0.16	0.16
<b>Maintenance and wear</b>				
Share of investment costs	%	1	1	1
Specific costs of maintenance	EUR/t	0.15	0.15	0.13
Specific costs of filter wear	EUR/t	0.78	0.78	0.78
<b>Investment costs</b>				
Specific investment costs	EUR/t	1.58	1.49	1.37
<b>Rated specific overall costs</b>	<b>EUR/t</b>	<b>4.28</b>	<b>4.18</b>	<b>4.05</b>

**Table 10.33: Specific costs of a flow injection absorber as a function of waste throughput**  
[3, Austria, 2002]

## Activated coke plant

Parameter	Units	Throughput per line		
		75000 t/yr	100000 t/yr	150000 t/yr
<b>Consumption of electricity</b>				
Specific consumption	kWh/t	10	10	10
Specific costs of energy consumption	EUR/t	0.25	0.25	0.25
<b>Activated coke consumption</b>				
Specific consumption	kg/t	2.00	2.00	2.00
Specific costs	EUR/t	0.60	0.60	0.60
<b>Maintenance and wear</b>				
Share of investment costs	%	1	1	1
Specific	EUR/t	0.37	0.36	0.33
<b>Investment costs</b>				
Specific investment costs	EUR/t	3.84	3.71	3.43
<b>Rated specific overall costs</b>	<b>EUR/t</b>	<b>5.07</b>	<b>4.92</b>	<b>4.62</b>

**Table 10.34: Specific costs of an activated coke plant as a function of waste throughput [3, Austria, 2002]**

### 10.2.5 Cost estimations for some complete MSWI plants

[3, Austria, 2002]

In order to estimate the costs of whole plants, the following assumptions are made:

At a plant with a waste throughput of 100000 t/yr an arrangement based on one line, for 200000 t/yr two lines of 100000 t/yr each and for 300000 t/yr two lines of 150000 t/yr each are assumed.

The investment costs that have been estimated here for the particular plant components, only refer to the systems engineering and hardware costs. Therefore, additional costs relating to construction, electrical and mechanical costs (EMC), and other infrastructure measurements need to be added. The following costs are estimated for these:

- construction costs + 20 % of plant cost
- EMC + 15 % of the plant cost.

Other investment costs such as costs for planning of the plant, and other infrastructure, differ marginally with plant size. Labour costs were calculated for the whole plant and, thus, have not been considered in the estimations for the particular plant components. In the cost calculations only expenses for those personnel that are directly necessary for the plant operation are included. Differences in the distribution and administration systems have been neglected.

The investment costs were calculated statically based on a duration of 15 years and at a rate of interest of 6 %. Furthermore, full load operation of the plant with a yearly operating time of 7500 h was assumed. In the rated costs, some aspects, such as costs for construction interests, leading personnel, administration, advertising, and insurance are not included. Thus costs calculated under these assumptions are at least 30 to 40 % too low and therefore calculated as *rated specific overall costs*. To make cost estimations more realistic, 40 % was added to the rated specific overall costs and the resulting cost were named *estimated specific overall costs*.

Cost estimations for different plants are based on the same simplified assumptions. Thus the relations of different plants correspond to practical experiences.

In the tables below, the following differences between plants are illustrated:

- different plant size
- different energy utilisation on the basis of uniform prices
- different flue-gas cleaning systems.

The assumptions made are described in the titles of Table 10.35 to Table 10.40.

The figure below shows examples of the impact of plant size and the energy utilisation option on the specific waste treatment costs of new MSWI installations:

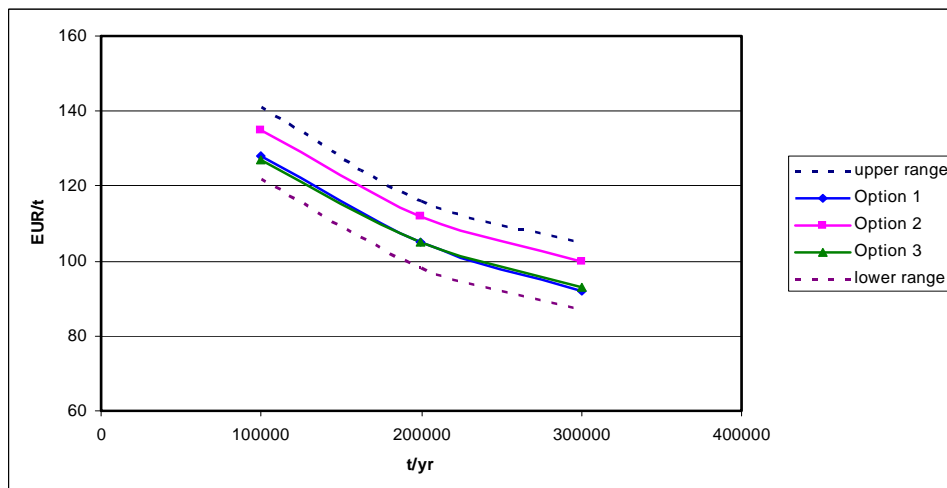

**Figure 10.5: The impact of plant size and energy utilisation on the specific waste treatment costs of new MSWI installations**  
[3, Austria, 2002], [64, TWGComments, 2003]

Plant size has a great influence on the overall costs of a plant. The maximum difference between small and large plants is about EUR 37 per tonne incinerated waste. The means of energy utilisation shifts the costs by about EUR 9 per tonne. Integration of steam in existing power plant (option 1) and cogeneration (option 3) lead to lower overall costs than pure electricity production (option 2).

Figure 10.6 shows the specific waste treatment cost structure for MSWI installations using different flue-gas treatment techniques, but with the same energy utilisation option:

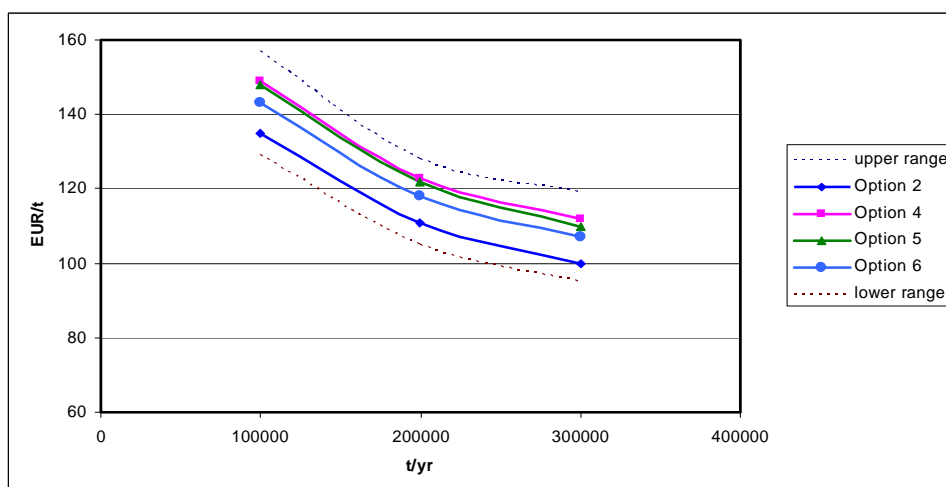

**Figure 10.6: The impact of varying FGT systems and plant sizes on the treatment costs of new MSWI installations using the same energy utilisation techniques**  
[3, Austria, 2002], [64, TWGComments, 2003]

In the options that are shown in Figure 10.6, only electricity is produced from waste incineration. Again it is shown that the overall costs of a plant mainly depend on the size (maximum difference: EUR 37 per tonne), whereas the maximum difference as a function of the flue-gas cleaning system is EUR 13 per tonne.

On the whole, the range of overall costs shown in both figures is between 92 and 148 EUR per tonne of incinerated waste.

For smaller throughput plants (e.g. below 100000 tonnes/yr), because the overall quantity of heat produced is lower, it can be easier to find a heat user. In such cases most of the heat produced by the plant may be sold. This income from heating energy may then reduce the gate fee for received waste to the level where the small scale of the plant actually becomes an economic advantage. For example: where steam sells at a price of 15 - 20 EUR/MWh, and 2 - 2.5 MWh of heat is produced per tonne of waste, this yields steam income in the range of EUR 30 – 50 per tonne waste. [64, TWGComments, 2003]

In rural regions, a plant capacity of 300000 t/yr can correspond to a waste collection area radius of about 80 – 100 km. For small plants the cost difference between direct delivery with the refuse collection vehicle and delivery with an overall logistic of collection, reloading to train and transport by train is between EUR 10 and 15/t. Thus lower logistic costs at small plants can compensate the higher specific treatment costs only to a small degree.

Parameter	Units	Throughput		
		100000 t/yr	200000 t/yr	300000 t/yr
Costs for discharge and storage using refuse collection vehicles	EUR/t	5.20	4.24	3.77
Additional costs for discharge and storage using the train	EUR/t	3.99	2.66	2.22
Firing system and boiler	EUR/t	36.42	36.42	35.08
Water steam cycle (option 3)	EUR/t	5.20	8.19	9.85
Dry flue-gas cleaning	EUR/t	7.21	7.21	7.08
Gypsum scrubber	EUR/t	5.48	5.48	5.07
Catalytic flue-gas cleaning	EUR/t	3.20	3.20	3.02
Investment costs of systems engineering	EUR	33650000	59100000	78000000
Construction	EUR	6730000	11820000	15600000
EMC	EUR	5047500	8865000	11700000
Other investment costs	EUR	6000000	7000000	8000000
Specific costs for construction, EMC + others	EUR/t	18.30	14.25	12.12
Personnel costs	EUR/yr	1700000	1800000	2000000
Specific personnel costs	EUR/t	17.00	9.00	6.67
<b>Rated overall costs</b>	<b>EUR/t</b>	<b>91.60</b>	<b>74.27</b>	<b>65.16</b>
<b>Estimated overall costs</b>	<b>EUR/t</b>	<b>128</b>	<b>104</b>	<b>91</b>

**Table 10.35: Option 1: Costs of a grate firing system incorporating delivery by train, dry, wet and catalytic flue-gas treatment and with the steam cycle connected to that of an adjacent power plant as a function of throughput [3, Austria, 2002]**

Parameter	Units	Throughput		
		100000 t/yr	200000 t/yr	300000 t/yr
Costs for discharge and storage using refuse collection vehicles	EUR/t	5.20	4.24	3.77
Additional costs for discharge and storage using the train	EUR/t	3.99	2.66	2.22
Firing system and boiler	EUR/t	36.42	36.42	35.08
Water steam cycle (option 2)	EUR/t	0.36	3.02	3.91
Dry flue-gas cleaning	EUR/t	7.21	7.21	7.08
Gypsum scrubber	EUR/t	5.48	5.48	5.07
Catalytic flue-gas cleaning	EUR/t	3.20	3.20	3.02
Investment costs of systems engineering	EUR	33150000	58600000	79000000
Construction	EUR	6630000	11720000	15800000
EMC	EUR	4972500	8790000	11850000
Other investment costs	EUR	6000000	7000000	8000000
Specific costs for construction, EMC + others	EUR/t	18.12	14.16	12.24
Personnel costs	EUR/yr	1700000	1800000	2000000
Specific personnel costs	EUR/t	17.00	9.00	6.67
<b>Rated overall costs</b>	<b>EUR/t</b>	<b>96.26</b>	<b>79.35</b>	<b>71.22</b>
<b>Estimated overall costs</b>	<b>EUR/t</b>	<b>135</b>	<b>111</b>	<b>100</b>

**Table 10.36: Option 2: Costs of a grate firing system incorporating delivery by train, dry, wet and catalytic flue-gas treatment with power generation as a function of throughput [3, Austria, 2002]**

Parameter	Units	Throughput		
		100000 t/yr	200000 t/yr	300000 t/yr
Costs for discharge and storage using refuse collection vehicles	EUR/t	5.20	4.24	3.77
Additional costs for discharge and storage using the train	EUR/t	3.99	2.66	2.22
Firing system and boiler	EUR/t	36.42	36.42	35.08
Water steam cycle (option 4)	EUR/t	5.41	8.07	9.40
Dry flue-gas cleaning	EUR/t	7.21	7.21	7.08
Gypsum scrubber	EUR/t	5.48	5.48	5.07
Catalytic flue-gas cleaning	EUR/t	3.20	3.20	3.02
Investment costs of systems engineering	EUR	34150000	60600000	81000000
Construction	EUR	6830000	12120000	16200000
EMC	EUR	5122500	9090000	12150000
Other investment costs	EUR	6000000	7000000	8000000
Specific costs for construction, EMC + others	EUR/t	18.48	14.52	12.48
Personnel costs	EUR/yr	1700000	1800000	2000000
Specific personnel costs	EUR/t	17.00	9.00	6.67
<b>Rated overall costs</b>	<b>EUR/t</b>	<b>91.57</b>	<b>74.66</b>	<b>65.97</b>
<b>Estimated overall costs</b>	<b>EUR/t</b>	<b>128</b>	<b>104</b>	<b>92</b>

**Table 10.37: Option 3: Costs of a grate firing system incorporating delivery by train, dry, wet and catalytic flue-gas treatment with cogeneration (CHP) as a function of throughput [3, Austria, 2002]**



Parameter	Units	Throughput		
		100000 t/yr	200000 t/yr	300000 t/yr
Costs for discharge and storage using refuse collection vehicles	EUR/t	5.20	4.24	3.77
Additional costs for discharge and storage using the train	EUR/t	3.99	2.66	2.22
Firing system and boiler	EUR/t	36.42	36.42	35.08
Water steam cycle (option 2)	EUR/t	0.36	3.02	3.91
Electrostatic precipitator	EUR/t	5.89	5.89	5.73
NaOH scrubber	EUR/t	11.14	11.14	10.96
Flow injection absorber	EUR/t	4.18	4.18	4.05
Catalytic flue-gas cleaning	EUR/t	3.20	3.20	3.02
Investment costs systems of engineering	EUR	37250000	59400000	80200000
Construction	EUR	7450000	11800000	16040000
EMC	EUR	5587500	8910000	12030000
Other investment costs	EUR	6000000	7000000	8000000
Specific costs for construction, EMC + others	EUR/t	19.60	14.31	12.38
Personnel costs	EUR/yr	1700000	1800000	2000000
Specific personnel costs	EUR/t	17.00	9.00	6.67
<b>Rated overall costs</b>	<b>EUR/t</b>	<b>106</b>	<b>88</b>	<b>80</b>
<b>Estimated overall costs</b>	<b>EUR/t</b>	<b>148</b>	<b>123</b>	<b>112</b>

**Table 10.38: Option 4: Costs of a grate firing system incorporating delivery by train, electrostatic precipitator, NaOH scrubber, flow injection absorber and catalytic plant with power generation as a function of throughput [3, Austria, 2002]**

Parameter	Units	Throughput		
		100000 t/yr	200000 t/yr	300000 t/yr
Costs for discharge and storage using refuse collection vehicles	EUR/t	5.20	4.24	3.77
Additional costs for discharge and storage using the train	EUR/t	3.99	2.66	2.22
Firing system and boiler	EUR/t	36.42	36.42	35.08
Water steam cycle (option 2)	EUR/t	0.36	3.02	3.91
Electrostatic precipitator	EUR/t	5.89	5.89	5.73
Scrubber with precipitation	EUR/t	8.78	8.78	8.37
Activated coke absorber	EUR/t	4.92	4.92	4.62
Catalytic flue-gas cleaning	EUR/t	3.20	3.20	3.02
Investment costs of systems engineering	EUR	40500000	65300000	88200000
Construction	EUR	8100000	13060000	17640000
EMC	EUR	6075000	9795000	13230000
Other investment costs	EUR	6000000	7000000	8000000
Specific costs for construction, EMC + others	EUR/t	20.77	15.37	13.34
Personnel costs	EUR/yr	1700000	1800000	2000000
Specific personnel costs	EUR/t	17.00	9.00	6.67
<b>Rated overall costs</b>	<b>EUR/t</b>	<b>105.82</b>	<b>87.46</b>	<b>78.90</b>
<b>Estimated overall costs</b>	<b>EUR/t</b>	<b>147</b>	<b>122</b>	<b>110</b>

**Table 10.39: Option 5: Costs of a grate firing system incorporating delivery by train, electrostatic precipitator, precipitation, activated coke absorber and catalytic plant with power generation as a function of throughput [3, Austria, 2002]**

Parameter	Units	Throughput		
		100000 t/yr	200000 t/yr	300000 t/yr
Costs for discharge and storage using refuse collection vehicles	EUR/t	5.20	4.24	3.77
Additional costs for discharge and storage using the train	EUR/t	3.99	2.66	2.22
Firing system and boiler	EUR/t	36.42	36.42	35.08
Water steam cycle (option 2)	EUR/t	0.36	3.02	3.91
Dry adsorption	EUR/t	12.63	12.63	12.44
Activated coke absorber	EUR/t	4.92	4.92	4.62
Catalytic flue-gas cleaning	EUR/t	3.20	3.20	3.02
Investment costs of systems engineering	EUR	38475000	61250000	83000000
Construction	EUR	7695000	12250000	16600000
EMC	EUR	5771000	9187500	12450000
Other investment costs	EUR	6000000	7000000	8000000
Specific costs for construction, EMSR + others	EUR/t	20.04	14.64	12.72
Personnel costs	EUR/yr	1700000	1800000	2000000
Specific personnel costs	EUR/t	17.00	9.00	6.67
<b>Rated overall costs</b>	<b>EUR/t</b>	<b>103.04</b>	<b>84.69</b>	<b>76.61</b>
<b>Estimated overall costs</b>	<b>EUR/t</b>	<b>144</b>	<b>119</b>	<b>107</b>

**Table 10.40: Option 6: Costs of a grate firing system incorporating delivery by train, dry adsorption, activated coke absorber and catalytic plant with power generation as a function of throughput [3, Austria, 2002]**

### 10.2.6 Costs of fluidised bed combustion for MSW

The feedstock of a fluidised bed (FB) must be crushed or shredded before it can be processed in the FB combustion unit. Big inerts, glass and ferrous/non ferrous materials may also be extracted before feeding the combustion chamber to avoid clogging of air inlets and disruption in the fluidisation. The result is that the material fed to the combustion unit has a lower ash content (approximately 10 % instead of 25 %) than unsorted waste. [64, TWGComments, 2003]

The pretreatment required to prepare unsorted MSW for FBC typically costs EUR 10 to 30. This must be added when considering the overall treatment cost. [64, TWGComments, 2003]

Five FBC units were constructed in France between 1995 and 1997. Two separate technologies are employed: TMC dense fluidised bed (DFB) (Guerville, Doullens and Monthyon) and rotating fluidised bed (RFB) (by ABT/Lurgi in Gien and Sausheim). The following operational comments, some with an impact on costs issues, were noted [64, TWGComments, 2003]:

- availability ranges were low, from 65 % to 80 % for the best lines
- construction and commissioning phases were longer than initially anticipated
- excellent combustion performance was confirmed, unburnt matter content of less than 0.3 % in bottom ash
- energy efficiency is considerably lower than for grate-fired units
- a slight reduction in NO<sub>x</sub> and low CO emissions
- other emissions similar to grate firing systems.

Load flexibility, absence of thermal inertia and the capacity to handle wastes with a high net calorific value are reported to be of low real benefit.

Total investment costs for the 5 French units vary between 1.5 and 5.8 million EUR/(t/h). Total operational cost vary between EUR 39 and 136/t MSW treated. [64, TWGComments, 2003]

The calorific value and ash content of the wastes treated in fluidised beds vary widely. The specific costs for combustion strongly depend on these two parameters. In order to obtain comparable figures, in this study the following assumptions were made [3, Austria, 2002] (see Tables 10.41 to 10.43 below):

- ash content of the prepared waste: 10 %
- calorific value of the prepared waste: 15 MJ/kg.

These parameters roughly correspond to those of sorted fractions from waste. For a comparison of the specific costs of combustion of unsorted waste on a grate firing system, plants with the same rated thermal input were investigated.

For fluidised bed combustion, estimations were based on a stationary fluidised bed reactor with a capacity of 70000 t/yr and a circulating fluidised bed with a capacity of 200000 t/yr in one line each using the waste parameters above.

These data correspond to grate firing systems with a capacity of 100000 t/yr and 300000 t/yr (calorific value of waste: 10 MJ/kg). However, in the latter case two combustion lines were assumed. Few plant constructors offer plants with a yearly capacity of 300000 t per line.

Regarding the energy utilisation, option 2 was the basis for both firing systems.

Costs for flue-gas treatment have been assumed to be the same for both systems, and the same emission limit values applied. In reality, for processes observing the same emission limit values, the FGT costs are likely to be lower with FBC than with a grate incinerator processing the same throughput of waste. [64, TWGComments, 2003]

On the basis of the assumptions made in this study and a capacity of 70000 t/yr of pretreated waste (fluidised bed), or 100000 t/yr of untreated waste (grate firing), approximately the same specific treatment costs will arise based on the rated thermal input. Based on the mass throughput incineration costs of fluidised bed combustion systems are noticeably higher than those of a grate firing systems (see Table 10.43). However, for larger plants, with a throughput of 200000 t/yr treated waste (for fluidised bed combustion) or 300000 t/yr untreated waste (for grate firing), specific costs related to the rated thermal input are shown in this study more favourable if fluidised bed combustion is applied. However, if waste first has to be separated into low and high calorific fractions and then subsequently crushed, ground, and separated, the subsequent combustion in a fluidised bed reactor will be less economically favourable in comparison to a grate firing. [64, TWGComments, 2003]

Parameter	Throughput	
	70000 t/yr	200000 t/yr
Investment costs (EUR)	c. 10 million	c. 23 million
Specific investment costs (EUR/t)	14.71	11.84
Yearly maintenance costs as share of investment costs (%/yr)	3	3
Specific maintenance costs (EUR/t)	4.29	3.45
Average overall consumption of electricity (normal operation) (kW/t)	57	67
Costs of electricity (EUR/t)	1.44	1.67
Amount of bottom ash and boiler ash (kg/t)	100	100
Disposal costs of bottom ash and boiler ash (EUR/t)	6	6
<b>Specific costs of firing and boiler (EUR/t)</b>	<b>26.43</b>	<b>22.96</b>

**Table 10.41: Costs for the firing system and the boiler of waste incineration plants with fluidised bed combustion as a function of throughput (not including waste pretreatment costs) [3, Austria, 2002], [64, TWGComments, 2003]**

Costs of a steam cycle: steam extraction turbine applying steam parameters of 50 bar and 400 °C (corresponding to option 2 and a grate firing system):

In addition to the presumptions made in option 2 for grate firing systems the higher calorific value is considered.

Parameter	Throughput	
	70000 t/yr	200000 t/yr
Investment costs (EUR)	c. 8 million	c. 16 million
Specific investment costs (EUR/t)	11.77	8.24
Specific maintenance costs (EUR/t)	3.43	1.40
Delivery of heat (MWh/t)	0	0
Delivery of electricity (MWh/t)	0.66	0.66
Specific proceeds from electricity production (EUR/t)	16.5	16.5
<b>Rated proceeds from water-steam (EUR/t)</b>	<b>1.30</b>	<b>5.86</b>

**Table 10.42: Specific costs of a water-steam cycle comprising a steam extraction turbine (normal steam parameters) as a function of waste throughput [3, Austria, 2002]**

#### Comparison of costs of grate and fluidised bed systems with the same thermal output:

Parameter	Units	Throughput (t/yr)			
		70000	100000	200000	300000
Grate firing system	EUR/t		36.01		31.18
	EUR/GJ		3.6		3.12
Fluidised bed without waste crushing and grinding	EUR/t	36.52		21.75	
	EUR/GJ	3.77		2.78	
Fluidised bed with waste crushing and grinding <sup>1</sup>	EUR/t	56.52		41.75	

<sup>1</sup> For crushing and grinding of waste an expense of 20 EUR/t was assumed.

**Table 10.43: Specific costs and income of waste treatment, firing, boiler and energy utilisation Source [3, Austria, 2002]**

### 10.2.7 Gasification and pyrolysis system costs for MSW

This section is based on [43, Eunomia, 2001] and [64, TWGComments, 2003]

Gasification and pyrolysis are not as widely applied for wastes as conventional incineration. Cost data provided may therefore be subject to more variation than that provided for incineration installations.

There is one full-scale gasification plant in Finland, in the city of Lahti, which uses MSW-based recycled fuel. The gasification unit (50 MW) produces gas to be used in a larger, main boiler, which uses coal as main fuel.

The gasifier uses, in addition to selected waste from households, industrial wood based waste such as bark, sawdust, plywood and chipboard. The fraction from households is about 30 - 40 % of input energy.

Fuel receiving, processing (shredding and sieving) and feeding are connected to a gasifier. Energy waste from households is sorted and collected separately, and principally it needs only shredding to be made fuel. The gate fee for separately collected waste from households is zero.

The personnel of the main boiler operate and control the gasification process, so the gasifier does not have significant labour costs of its own. The flue-gas treatment process is in the main boiler, and it has not been included in the gasifier costs. These explain the relatively high profitability of the gasifier as represented in Table 10.44 below.

Investment and operating costs of fuel processing and gasification plant are also shown in Table 10.44 below. The gasification plant is owned and operated by a private sector company, Lahti Energy Ltd.

Capital costs include the profit of the contractor and process provider. VAT is excluded. Operating costs of the gasifier are the prime costs of operator, and do not include profit or VAT. It is important to note that, in the operating costs of fuel processing, including the profit of the contractor (services bought from the private sector), VAT is excluded. This can add significantly to costs.

Key factors expected to influence future costs:

The EU Directive (2000/76/EC) on the incineration of waste will increase the emission monitoring costs and also make the emission limits tighter.

<b>Costs for Gasification plant</b>	<b>Cost/ EUR</b>
Capacity 100000 tonnes per year (total of all fuels input to gasifier)	
<b>Capital costs:</b>	
Fuel processing and feeding	4204698
Gasifier unit	7568456
<b>Total capital costs</b>	<b>11773154</b>
<b>Operational Cost:</b>	
Gasifier	213598
Fuel processing and feeding	267419
Fuel costs (other than waste from households)	882986
<b>Total operational costs</b>	<b>1364003</b>
<b>Total annual costs</b>	<b>2656632</b>
Revenues per year:	
Electricity sales (0.034 EUR/kWh)	3531946
District heating sales (0.017 EUR/kWh)	1765973
<b>Revenues total</b>	<b>5297919</b>
Note: Depreciation Period = 15 years at interest rate = 7 %	

**Table 10.44: Capital and operating costs of the Lahti RDF gasification plant, Finland [43, Eunomia, 2001],**

Current pyrolysis/gasification costs in the UK have been estimated (no projects have been brought into full-scale operation) at approximately EUR 40 – 160 per tonne with most suppliers falling in the range EUR 56 - 88 per tonne. Other evidence suggests the lower end of the range may apply for gasification technologies (i.e., in the order of EUR/40/t).

The only operating plant in Europe (Karlsruhe) has a gate fee of 140 EURO/t at a capacity of 225000 t/yr. But as reported by the operator, the investment cost for this plant has increased by about EUR 40 million due to the modifications necessary. In addition, all figures reported so far, show a yearly throughput of waste of max. 50 % of the design capacity.

Hypothetical calculated costs for a 150000 tonne pyrolysis plant are shown in Table 10.45.

	<b>Costs per tonne for pyrolysis</b>
<b>COSTS</b>	
Capital cost per tonne	EUR 64.99
Operational cost	EUR 58.96
Fixed	EUR 0.00
Variable	EUR 0.00
Overhead	EUR 17.34
Total	EUR 141.30
<b>REVENUES</b>	
Materials	- EUR 3.57
Electricity production	- EUR 4.77
Total	- EUR 8.34
<b>NET COST</b>	EUR 132.96
Quantity RDF (kg/tonne)	0

**Table 10.45: Hypothetical cost calculations for a pyrolysis plant in the Flanders Region of Belgium**  
Source [43, Eunomia, 2001]

At the time of writing, the additional technological risk associated with the adoption of gasification and pyrolysis for many wastes, remains significantly greater than that for better proven, incineration type thermal treatments. The additional risks may diminish with proven market experience and evidence of reliability with commonly encountered waste inputs.

### 10.3 Example installation descriptions

This annexe contains a selection of installation descriptions of entire operational installations. The installations that are included here were chosen because the descriptions provided were accompanied by thorough quantitative data (which also included here), and because together they cover a very wide range of situations, waste types and technologies. They are presented in order to provide examples of the actual overall design and performance levels achieved at those example installations. It is not intended that the examples themselves provide examples of what is BAT or is not BAT - the conclusions of the BREF technical working group on BAT are given in Chapter 5.

### 10.3.1 Examples of municipal waste incineration

#### 10.3.1.1 Grate incinerator with SCR and steam distribution

196605 tonnes of domestic waste from Vienna City were incinerated in the waste incineration plant Flötzersteig in the year 2000. General data of this plant are presented in Table 10.46.

Waste incineration plant Flötzersteig	
Operator	Fernwärme Vienna GmbH
Start up	1963
Firing technology	Grate firing
Waste throughput	196605.52 t
Average net calorific value	8862 kJ kg <sup>-1</sup>
Average gross calorific value	9400 kJ kg <sup>-1</sup>
Theoretical rated thermal input	62 MW
Working hours line 1	8011
Working hours line 2	8066
Working hours line 3	8207

**Table 10.46: General data of the waste incineration plant Flötzersteig (reference year: 2000)**

A process flow diagram of one of the three incineration lines is shown in Figure 10.7. Each line consists of the following units:

- waste bunker
- firing system: Combined forward and backward moving grate
- waste heat boiler
- flue-gas cleaning devices consisting of: electrostatic precipitator, three-stage wet scrubber, catalytic flue-gas cleaning system for NO<sub>x</sub> and dioxin removal
- multistage waste water treatment plant
- steam distribution system.

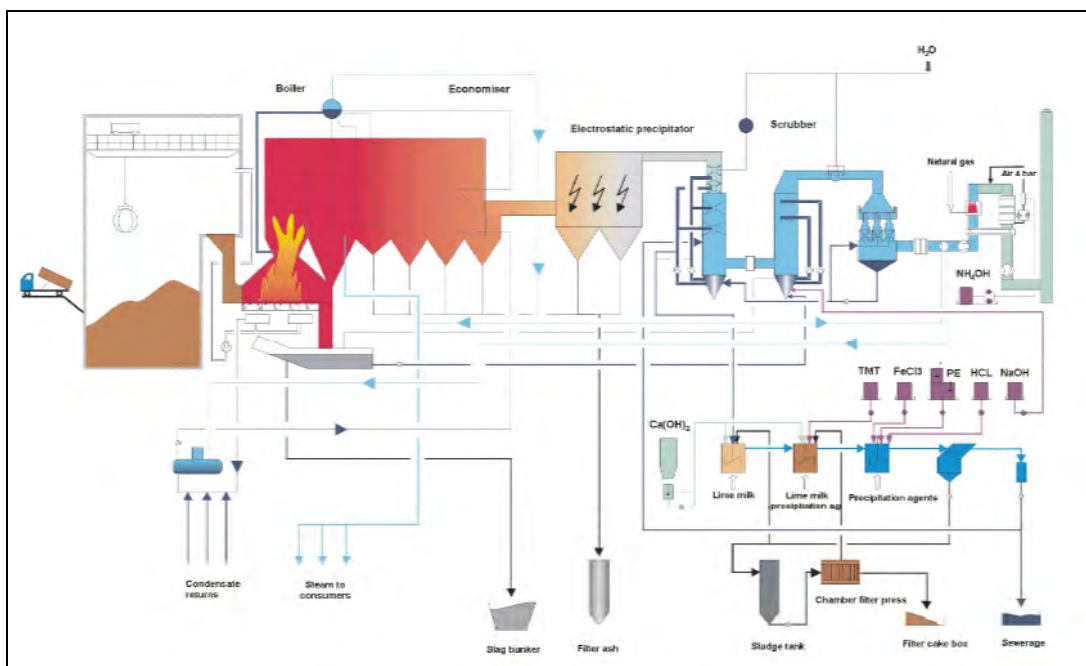

**Figure 10.7: Process flow scheme of the waste incineration plant Flötzersteig**

Table 10.47 shows an input/output balance of the waste incineration plant Flötzersteig related to one tonne of waste.

Input related to one tonne of waste		Output related to one tonne of waste	
Heat	283.6 kWh	Heat	1980 kWh
Electricity	79.0 kWh	Electricity	-
Natural gas	16.38 m <sup>3</sup>	Steam (p = 16 bar; T = 270 °C)	2.75 t
Fresh water	825 l	Slag	255.6 kg
Lime	2.46 kg	Metal scrap	-
Sodium hydroxide, 30 %	3.48 kg	Fly ash	15.6 kg
Ammonia, 25 %	1.87 kg	Filter cake (20 – 30 % H <sub>2</sub> O)	0.93 kg
Precipitating agents	0.25 kg	Cleaned waste water	312.6 l
Polyelectrolyte	0.003 kg	Cleaned flue-gas (dry)	5100 Nm <sup>3</sup>
Hydrochloric acid	0.075 kg		

**Table 10.47: Input and output flows of the waste incineration plant Flötzersteig (reference year: 2000)**

### Acceptance, treatment and storage of waste

Domestic waste from Vienna is delivered by 230 refuse collection vehicles. Each vehicle contains 4 – 5 t waste on average. After weighing waste is dumped into the waste bunker that consists of a daily bunker and a bulk storage bunker. The size of the storage bunker is equivalent to the volume of a waste delivery over a period of three days.

### Waste introduction and supply with combustion air

The storage bunker as well as three chutes (funnel tubes) are fed with waste grapples from two cranes. Waste is introduced by chutes, pushed onto the combustion grate and combusted with preheated air.

### Utilisation of energy

The combustion grate is followed by a steam boiler (evaporator heating surface: 1695 m<sup>2</sup>) with superheater (370 m<sup>2</sup>) and economiser (220 m<sup>2</sup>). The produced superheated steam has a temperature of 270 °C and 16 bar.

Steam pipelines in accessible canals lead to proximate bulk purchasers. Residual heat is fed into the remote district heating network via two converting stations.

### Flue-gas cleaning system and emissions to the air

*Electrostatic precipitator:* Each line is equipped with an electrostatic precipitator with two fields for separation of coarse particles. The dust load is reduced from about 3.000 mg Nm<sup>-3</sup> to 20 – 40 mg Nm<sup>-3</sup> and finally reduced to about 2 mg Nm<sup>-3</sup> by the flue-gas cleaning system before the stack.

*Wet flue-gas cleaning:* Flue-gas from each line is washed by three scrubbers. In the first scrubber flue-gases are cooled from a temperature of 200 °C to 60 – 70 °C and saturated with steam. In the lower part of the scrubber a water film is created by circular nozzles so that HCl, HF, heavy metals, Hg and part of the residual dust are washed out. The pH of the washing water is held constant by addition of lime milk to a value of 1.5. In the second (pH neutral) scrubber SO<sub>2</sub> is separated by addition of NaOH whereby a mixture of Na<sub>2</sub>SO<sub>4</sub> and Na<sub>2</sub>SO<sub>3</sub> is produced. A part of the wash-water is routed to the wet slag removal where gypsum is precipitated and removed together with slag. Fine dust is separated in the third treatment step by a venturi scrubber.



*Catalytic NO<sub>x</sub> removal and dioxin destruction:* Before entering the catalyst the flue-gas is reheated from 60 to 130 °C by means of steam heat exchangers. Previously after the entrance valve an evaporated aqueous ammonia solution is added to the raw gas. After reaction in the catalyst the flue-gas is cooled by a heat pipe and conducted to the stack via the flue-gas fan. Emission levels that can be achieved by these plants are presented in Table 10.48.

Parameter	Emission (mg Nm <sup>-3</sup> ) <sup>a</sup>			Total mass (kg yr <sup>-1</sup> ) <sup>b,d</sup>	Specific emissions (g t <sup>-1</sup> ) <sup>c,d</sup>
	Min.	Average value	Max.		
Dust <sup>*</sup>	0.5	2.1	9.1	2105.64	10.71
HCl <sup>*</sup>	0.1	1.6	8.1	1604.3	8.16
HF		0.14		140.38	0.71
SO <sub>2</sub> <sup>*</sup>	0.1	10.4	53.6	10427.93	53.04
C <sub>org</sub> <sup>*</sup>	0.1	0.7	7.2	701.88	3.57
CO <sup>*</sup>	1.2	15.2	98.3	15240.82	77.52
NO <sub>x</sub> as NO <sub>2</sub> <sup>*</sup>	0.1	30.5	87.3	30581.91	155.55
Pb		0.044		44.12	0.22
Cr		<0.001		1	0.0051
Zn		0.114		114.31	0.58
Σ Pb + Cr + Zn		<0.159		159.43	0.81
As		<0.001		1	0.0051
Co		<0.001		1	0.0051
Ni		<0.001		1	0.0051
Σ As + Co + Ni		<0.003		3	0.0153
Cd		0.002		2	0.01
Hg		0.036		36.1	0.18
NH <sub>3</sub> <sup>*</sup>		0.58		581.56	2.96
PCDD+PCDF		0.018 ng Nm <sup>-3</sup>		18.05 mg yr <sup>-1</sup>	0.0918 µg t <sup>-1</sup>

<sup>\*</sup> Continuous measurement  
<sup>a</sup> Half hourly average values in mg Nm<sup>-3</sup>; dioxin emissions are given in ng Nm<sup>-3</sup> (11 % O<sub>2</sub>; dry flue-gas; standard conditions)  
<sup>b</sup> In kg yr<sup>-1</sup>, dioxins in mg yr<sup>-1</sup>  
<sup>c</sup> Emissions related to one tonne used waste in g t<sup>-1</sup>; dioxin emissions in µg t<sup>-1</sup>  
<sup>d</sup> Total mass and specific emissions are calculated based on average half hourly mean values, using the quantity of dry flue-gas (5100 Nm<sup>3</sup> t<sup>-1</sup><sub>waste</sub>) and the waste quantity (196605 t yr<sup>-1</sup>).

**Table 10.48: Emissions to air from the waste incineration plant Flötzersteig (reference year: 2000)**

### Waste water treatment and emissions to water

Waste water first passes a neutralisation step where a part of the heavy metals precipitates. The other part is precipitated in the precipitation step which is then followed by a flocculation step. Accumulated sludge is separated in a baffle plate thickener before it is dewatered in a chamber filter press. A partial flow of the cleaned waste water is routed to the clean water tank, the rest is conducted into the sewage.

Following values presented in Table 10.49 can be achieved by this multistage waste water treatment system.

Parameter	Measured value (mg l <sup>-1</sup> )
Temperature	<30 °C
Electric conductance	20 mS
pH	7.6
Undissolved matter	<30
Settleable solids	<10
As	<0.003
Cd	0.001
Chlorides (Cl)	10000
Cyanides	<0.006
Cr	<0.05
Cu	0.11
Fluorides (F)	<0.006
Hg	<0.001
NH <sub>4</sub> (N)	3.16
Nitrate (NO <sub>3</sub> )	33
Nitrite (NO <sub>2</sub> )	0.14
Ni	<0.05
Pb	<0.01
Sulphate (SO <sub>4</sub> )	325
Sulphides	<0.1
Sulphites	<1.0
Zn	0.4
AOX/EOX	1.02/<0.02
BTXE	<0.025
Total HC	0.05
Phenol	<0.01

**Table 10.49: Waste water parameters of the waste incineration plant Flötzersteig after the waste water treatment (reference year: 2000)**

## Waste

*Slag:* At the end of the grate slag falls into the water filled wet deslagger where it is cooled. Afterwards it is transported to the slag bunker by a plate conveyor. From there slag is loaded onto trucks by using a crane and transported to a landfill.

*Fly ash:* Fly ash is transported to an intermediate silo using conveying screws. From there it is pneumatically conveyed into two ash silos.

Slag and ash are solidified by addition of water and cement and used for the erection of sidewalls for the landfill Rautenweg in Vienna.

*Filter cake from waste water treatment:* The filter cake from waste water treatment is filled into “big bags” and disposed of underground.

The composition of above-mentioned waste fractions is shown in Table 10.50. Results of leaching tests are given in Table 10.51.

Parameter	Measured value		
	Slag	Fly ash	Filter cake
Bulk density (kg m <sup>-3</sup> )	800 - 2300	500 - 800	
TOC (%) (air dried basis - ad)	1.5 - 2.5	1.5 - 2.0	
Σ(SO <sub>4</sub> +SO <sub>3</sub> ) (%) (ad)	1.5 - 8.0	4.5 - 17.0	
Cl (%) (ad)	0.2 - 0.5	7.5 - 11.5	
F (%) (ad)	0.01 - 0.1	0.1 - 0.3	
CO <sub>3</sub> (%) (ad)	3.0 - 15.0	2.5 - 15.0	
SO <sub>4</sub> (%) (ad)	1.5 - 5.0	4.5 - 12.5	
Total moisture (%) (ad)	15.0 - 40.0	0.1 - 0.5	
Loss on ignition (%) (ad)	1.5 - 4.5	0.5 - 3.0	
<b>Main components (mg kg<sup>-1</sup>) (dry basis)</b>			
Si	130000 - 220000	65000 - 130000	
Al	40000 - 110000	40000 - 70000	27500
Mg	10000 - 25000	10000 - 25000	29700
Fe	20000 - 40000	10000 - 20000	55100
Ca	120000 - 160000	150000 - 210000	183000
Na	15000 - 30000	30000 - 50000	2250
K	10000 - 25000	45000 - 120000	3040
<b>Heavy metals (mg kg<sup>-1</sup>) (dry basis)</b>			
Zn	1500 - 5000	12000 - 25000	15000
Pb	1000 - 3500	3000 - 7000	5900
Mn	400 - 1000	400 - 900	388
Cr	200 - 500	400 - 900	238
Cd	5 - 15	200 - 800	451
As	3 - 15	3 - 30	19
Hg	0.3 - 3.0	5 - 40	1590
Ni	50 - 700	100 - 700	313
<b>Organic compounds (µg kg<sup>-1</sup>)</b>			
Total PCDF	0.05 - 0.2	2 - 20	
Total PCDD	0.02 - 0.2	5 - 80	
TEQ	0.001 - 0.008	1.0 - 2.0	
Total PCB	<600	<600	
Total PAH	<50	<50	

**Table 10.50: Chemical data of wastes from the waste incineration plant Flötzersteig (reference year: 2000)**

Parameter	Concentration (mg kg <sup>-1</sup> ) <sup>a</sup>	
	Slag	Fly ash
Mg	<10	<10
Ca	1300	15000
SO <sub>4</sub>	1600	25000
Cl	1500	110000
NH <sub>3</sub> as N	7	3
NO <sub>3</sub> as N	<3	<3
NO <sub>2</sub> as N	5	0.5
DOC	200	20
Fe	<0.5	<0.5
Mn	<0.5	<0.5
Ni	<0.5	<0.5
Cd	<0.01	0.02
Cr	<0.5	<0.5
Cu	2.5	0.5
Pb	60	120
Zn	1.5	5
Hg	<0.01	<0.01

<sup>a</sup> Test details: Increased liquid to solid ratio (10:1); distilled water (T = 20 °C); no pH control; maximum particle size 10 mm; results in mg per kg dry residue.

**Table 10.51: Leaching tests; waste incineration plant Flötzersteig (reference year: 2000)**

### 10.3.1.2 Grate incinerator with SCR and CHP

In the year 2000 268912 tonnes of waste were combusted in the waste incineration plant Spittelau. General data of the waste incineration plant Spittelau are shown in Table 10.52.

Waste incineration plant Spittelau	
Operator	Fernwärme Vienna GmbH
Start up	1971
Firing technology	Grate firing
Waste throughput	268912.09 t
Average net calorific value	8822 kJ kg <sup>-1</sup>
Average gross calorific value	9400 kJ kg <sup>-1</sup>
Theoretical rated thermal input	85 MW
Working hours line 1	7812
Working hours line 2	7882

**Table 10.52: General data of the waste incineration plant Spittelau (reference year: 2000)**

### Plant concept

A process flow diagram of the waste incineration plant Spittelau is shown in Figure 10.8. Each line basically consists of the following units:

- waste bunker
- firing system: Reciprocating grate
- waste heat boiler
- flue-gas cleaning devices consisting of: Electrostatic precipitator, three-stage wet scrubber, catalyst for NO<sub>x</sub> removal and dioxin destruction
- multistage waste water treatment plant
- steam turbine, generator and heat decoupling system.

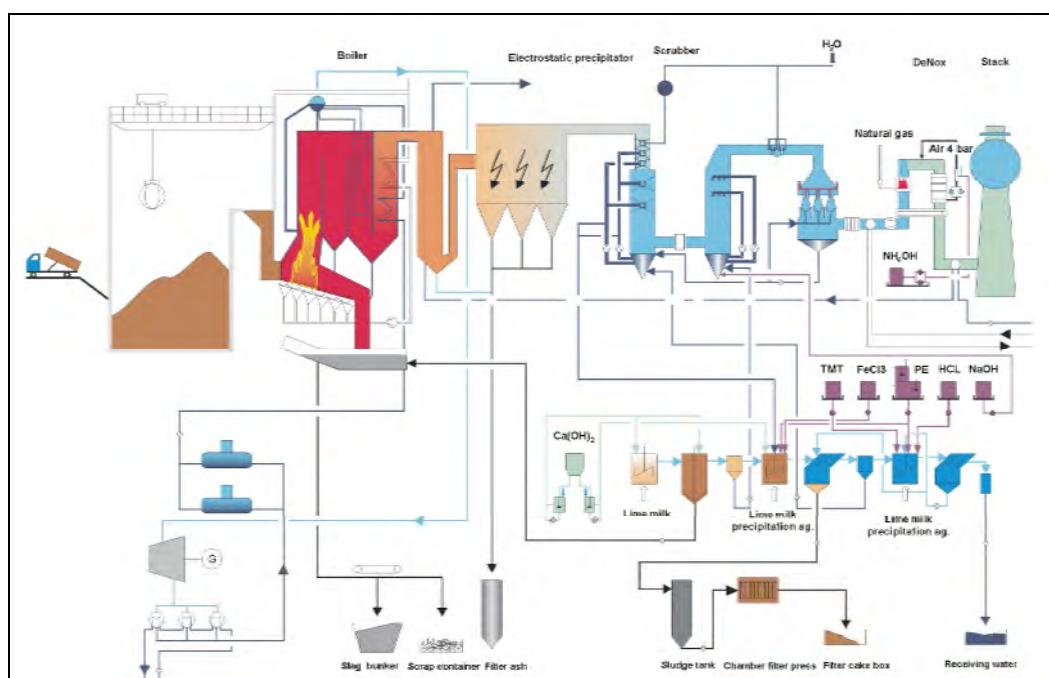

Figure 10.8: Process flow scheme of the waste incineration plant Spittelau

Table 10.53 shows an input-output balance of the waste incineration plant Spittelau related to one tonne of waste.

Input related to 1 t waste		Output related to 1 t waste	
Heat	27.6 kWh	Heat	1857 kWh
Electricity	78.5 kWh	Electricity	150 kWh
Natural gas	20.1 m <sup>3</sup>	Steam (p= 32 bar; T = 240 °C)	2.6 t
Fresh water	730 l	Slag	207 kg
Lime	2.9 kg	Metal scrap	22 kg
Sodium hydroxide, 30 %	2.25 kg	Fly ash	19 kg
Ammonia, 25 %	2.9 kg	Filter cake (15 – 20 % H <sub>2</sub> O)	1 kg
Precipitating agents, 15 %	0.17 kg	Cleaned waste water	415 l
		Cleaned flue-gas (dry)	4.545 Nm <sup>3</sup>

Table 10.53: Input-output flows of the waste incineration plant Spittelau (reference year: 2000)

### Acceptance, treatment and storage of waste

Domestic and similar industrial waste is delivered to the waste incineration plant Spittelau by 250 refuse collection vehicles per day. The vehicles are weighed on two weigh-bridges before waste is dumped into the waste bunker that has a volume of about 7.000 m<sup>3</sup>.

### Waste introduction and supply of combustion air

After mixing in the bunker waste is supplied to both combustion lines by two bridge cranes. Each crane grab has a capacity of 4 m<sup>3</sup>. Waste is fed onto the grate that is located at the lower end of the combustion chamber through a filling slot using hydraulic locators.

Fresh air needed for combustion is sucked off from the waste bunker. Thus a slight vacuum is produced so that odour and dust emissions through the dumping devices to the ambient air are minimised.

### **Grate firing system**

Up to 16 t waste per hour can be thermally treated on the sloped reciprocating grate with a total surface of 35 m<sup>2</sup>. With the heat content of the combustion gases 90 tonnes of saturated steam per hour are produced.

### **Utilisation of energy**

For electricity production steam is expanded in a backpressure turbine from 33 to 4.5 bar. The remaining energy of the steam is transferred to the return water of the remote district heating network in heat exchangers. On an yearly average more than 5 MW electricity for covering of own needs and for feeding into the public electricity network as well as 60 MW of district heat are produced

### **Flue-gas cleaning system and emissions to the air**

*Electrostatic precipitator:* Hot flue-gas with a temperature of 180 °C leaves the heat exchanger, that follows the waste heat boiler. Then it is dedusted in a three field electrostatic precipitator to a concentration <5 mg Nm<sup>-3</sup>.

*Wet flue-gas cleaning:* Dedusted flue-gas enters the quenching zone of the first wet scrubber, where it is cooled to saturation temperature (60 – 65 °C) by injection of fresh water. The first wet scrubber is built as cross flow scrubber working at a pH value of 1. Due to intensive contact between wash-water and flue-gas HCl, HF, dust as well as heavy metals are separated. The second wet scrubber is designed for desulphurization and is operated at a pH of 7. Flue-gas is adiabatically expanded in the downstream electrodynamic venturi scrubber where fine dust particles are separated after charging by an electrode.

*Catalytic NO<sub>x</sub> removal and dioxin destruction:* After reheating by a heat exchanger an evaporated aqueous solution of ammonia is added to the flue-gas. Flue-gas is further reheated to a reaction temperature of 280 °C by means of heat pipes and gas burners. In the catalyst (three layers) nitrogen oxides are converted to nitrogen and dioxins/furans are destroyed.

In a third heat exchanger flue-gases are cooled to 115 °C and discharged to the atmosphere via a 126 m high stack. The concentration of certain pollutants in the flue-gas is presented in Table 10.54.

Parameter	Emission (mg Nm <sup>-3</sup> ) <sup>a</sup>			Specific emissions (g t <sup>-1</sup> ) <sup>c,d</sup>	Total mass (kg yr <sup>-1</sup> ) <sup>b,d</sup>
	Min.	Average value	Max.		
Dust <sup>*</sup>	0.0	0.8	12.6	3.64	977.76
HCl <sup>*</sup>	0.0	0.8	8.2	3.64	977.76
HF		<0.02		<0.1	<27.8
SO <sub>2</sub> <sup>*</sup>	0.0	2.1	16.4	9.54	2566.63
CO <sup>*</sup>	1.4	26.3	91.2	119.53	32144
NO <sub>x</sub> as NO <sub>2</sub> <sup>*</sup>	0.0	22.9	92.8	104.08	27988.5
C <sub>org</sub> <sup>*</sup>	0.0	0.5	19.2	2.27	611.1
Pb		0.012		0.054	14.67
Cr		<0.001		0.045	1.22
Zn		0.032		0.145	39.11
Σ Pb+Cr+Zn		<0.045		0.2	54.99
As		<0.001		0.0045	1.22
Co		<0.001		0.0045	1.22
Ni		<0.002		0.009	2.44
Σ As+Co+Ni		<0.004		0.018	4.88
Cd		0.001		0.0045	1.22
Hg		0.007		0.032	8.56
NH <sub>3</sub>		0.7		3.18	855.54
PCDD+PCDF		0.02 ng Nm <sup>-3</sup>		0.091 mg yr <sup>-1</sup>	24.4 µg t <sup>-1</sup>

<sup>\*</sup> Continuous measurement; discontinuous values are arithmetic average values from a TÜV measurement (17.01.2001)

<sup>a</sup> Half hourly average values in mg Nm<sup>-3</sup>; dioxin emissions in ng Nm<sup>-3</sup> (11 % O<sub>2</sub>; dry flue-gas; standard conditions)

<sup>b</sup> In kg yr<sup>-1</sup>, dioxins in mg yr<sup>-1</sup>

<sup>c</sup> Emissions related to one tonne used waste in g t<sup>-1</sup>, dioxin emissions in µg t<sup>-1</sup>

<sup>d</sup> Total mass and specific emissions are calculated based on average half hourly mean values, using the quantity of dry flue-gas (5170 Nm<sup>3</sup> t<sup>-1</sup><sub>waste</sub>) and the waste quantity (269375 t yr<sup>-1</sup>).

**Table 10.54: Emissions to air from the waste incineration plant Spittelau (reference year: 2000)**

### Waste water treatment and emissions to water

Dissolved heavy metals from the first scrubber become insoluble by adding lime milk, precipitating and flocculation agents. Then they are separated by means of a downstream laminar clarifier. After the precipitation and the separation step has been passed repeatedly the hydroxide sludge is dewatered. Gypsum from the discharged water of the second scrubbing step is precipitated by addition of lime milk and then precipitated in the clarification basin. Gypsum sludge is pumped into the wet deslagger. Sodium hydroxide that is recovered is recycled into the second scrubber. The cleaned waste water is directly released into the receiving water.

Values that can be achieved by this multistage waste water treatment plant are shown in Table 10.55.

Parameter	Measured value (mg l <sup>-1</sup> )
Temperature	47.8 °C
Fish toxicity GF	2.0
pH value	7.8
Filterable substances	<20
Settleable solids	<0.3 ml/l
Sight depth	>30.0 cm
Residue on evaporation	1.4 g l <sup>-1</sup>
Colour	clear
Odour	neutral
Al	0.19
Ag	0.12
Ammonia (N)	3.3
As	<0.002
Ba	0.19
Ca	5056
Cd	<0.001
Co	<0.05
Cr <sub>total</sub>	<0.05
Cr (VI)	<0.05
Chlorine (free)	<0.05
Chlorine (total) Cl <sub>2</sub>	<0.05
Chloride (Cl)	7085
Cyanides (CN)	<0.006
Cu	<0.05
Fe	<0.05
Fluorides (F)	2.2
Hg	<0.001
Mn	<0.05
Nitrate (NO <sub>3</sub> )	4.8
Nitrite (NO <sub>2</sub> )	0.07
Ni	<0.05
P	<0.05
Pb	<0.01
Sb	0.04
Sn	0.06
Sulphate (SO <sub>4</sub> )	1183
Sulphide	<0.1
Sulphite	<1.0
Tl	<0.01
V	<0.05
Zn	<0.06
EOX	<0.02
CSB	<75
BTX	<0.025
Total HC	0.21
Phenol	<0.01
Tensides	<0.02
Non-volatile lipophilic components	<20
TOC	4.3

**Table 10.55: Waste water parameters of the waste incineration plant Spittelau after treatment (reference year: 2000)**



## Waste

*Slag:* At the end of the combustion grate slag falls into a water filled wet deslagger. From there the cooled slag is transported to the slag bunker by a belt conveyor.

*Filter ash:* Filter ash is transported to a silo using a mechano-pneumatic conveying system. Slag and filter ash are mixed with water and cement and used as slag/filter ash concrete in the landfill construction.

*Ferrous scrap:* Ferrous scrap is separated from cooled slag by an magnetic separator and supplied to the steel industry.

*Filter cake from waste water treatment:* Filter cake is filled into “big bags” and disposed of underground.

The composition of above-mentioned waste fractions is shown in Table 10.56. Results of leaching tests are presented in Table 10.57.

Parameter	Measured value		
	Slag	Fly ash	Filter cake
Bulk density (kg m <sup>-3</sup> )	800 - 1200	500 - 800	
TOC (%) (air dried basis - ad)	1.0 - 2.5	0.8 - 2.5	
Σ(SO <sub>4</sub> +SO <sub>3</sub> ) (%) (ad)	1.0 - 11.0	6.0 - 15.0	
Cl (%) (ad)	0.1 - 0.6	5.0 - 11.0	0.5 - 2.5
F (%) (ad)	0.01 - 0.1	0.1 - 1.5	0.5 - 1.5
CO <sub>3</sub> (%) (ad)	1.0 - 15.0	2.5 - 13.5	5.0 - 15.0
SO <sub>4</sub> (%) (ad)	1.0 - 8.0	6.0 - 11.0	15 - 30
Total moisture (%) (ad)	8.0 - 20.0	0.1 - 1.5	
Loss on Ignition (%) (ad)	1.0 - 4.5	0.5 - 3.0	
<b>Main components (mg kg<sup>-1</sup>) (dry basis)</b>			
Si	140000 – 280000	70000 - 160000	10000 - 70000
Al	30000 – 75000	40000 - 80000	1500 - 20000
Mg	10000 – 23000	70000 - 180000	1500 - 30000
Fe	30000 – 80000	10000 - 20000	10000 - 50000
Ca	120000 – 240000	130000 - 230000	200000 - 400000
Na	10000 – 45000	15000 - 65000	1000 - 10000
K	10000 - 25000	30000 - 75000	500 - 5000
<b>Heavy Metals (mg kg<sup>-1</sup>) (dry basis)</b>			
Zn	1200 - 5500	7000 - 20000	700 - 4500
Pb	500 – 5500	2500 - 7000	100 - 2000
Mn	300 – 1100	500 - 800	100 - 900
Cr	100 - 500	400 - 700	20 - 100
Cd	2 - 10	50 - 500	5 - 100
As	2 - 15	5 - 30	0.5 - 15
Hg	0.3 – 3.0	5 - 50	100 - 2000
Ni	50 - 400	50 - 200	20 - 160
<b>Organic compounds (µg kg<sup>-1</sup>)</b>			
Total PCDF	0.01 - 0.1	5 - 30	1.0 - 3.0
Total PCDD	0.01 - 0.2	5 - 35	4.0 - 8.0
TEQ	0.001 – 0.006	1.0 - 4.0	0.2 - 1.0
Total PCB	<600	<600	
Total PAH	<100	<100	

**Table 10.56: Chemical data of waste fractions from the waste incineration plant Spittelau (reference year: 2000)**

Parameter	Concentration (mg kg <sup>-1</sup> ) <sup>a</sup>		
	Slag	Fly ash	Gypsum
Mg	<10	<10	100
Ca	2000	15000	10300
SO <sub>4</sub>	100	25000	1900
Cl	2500	100000	4400
NH <sub>3</sub> as N	10	5	
NO <sub>3</sub> as N	<3	<3	13
NO <sub>2</sub> as N	0.5	0.5	0.3
DOC	250	15	14
Fe	0.5	0.5	<0.7
Mn	<0.5	<0.5	<0.7
Ni	<0.5	<0.5	<0.7
Cd	0.01	0.2	0.01
Cr	<0.5	<0.5	<0.7
Cu	5	0.5	<0.7
Pb	20	250	0.18
Zn	1.5	15	<0.7
Hg	<0.01	<0.01	<0.01

<sup>a</sup> Test details: Increased liquid to solid ratio (10: 1); distilled water (T = 20 °C); no pH control; maximum particle size 10 mm; results in mg per kg dry residue.

**Table 10.57: Leaching tests; waste incineration plant Spittelau (reference year: 2000)**

### 10.3.1.3 Grate incinerator with SCR, CHP and bottom ash treatment

In the year 2000, 40094 tonnes of domestic and trade waste, about 10000 tonnes of trade waste, building waste and bulky refuse each as well as about 4000 tonnes of residues from mechanical treatment and 1251 tonnes of feeding stuff were combusted in the waste incineration plant Wels. General data of the waste incineration plant Wels - line 1 are shown in Table 10.58.

Waste incineration plant Wels	
Operator	Welser Abfallverwertung – Betriebsführung GmbH
Start up	1995
Firing technology	Grate firing
Waste throughput	75681 t
Average gross calorific value	9.5 MJ kg <sup>-1</sup>
Theoretical rated thermal input	33.5 MW
Working hours line 1	8183

**Table 10.58: General data of the waste incineration plant Wels (reference year: 2000)**

### Plant concept

A process flow diagram of the waste incineration plant at Wels is shown below. The plant basically consists of the following units:

- waste bunker
- firing system: Grate firing (Combined forward and backward moving grate)
- waste heat boiler
- power generation and possibility of decoupling of district heat
- flue-gas cleaning devices: Electrostatic precipitator, two-stage wet scrubber, activated coke filter, catalytic flue-gas cleaning system
- residue treatment: Wet chemical/thermal ash treatment (thermal treatment not in operation), slag treatment
- multistage waste water treatment plant.

Table 10.59 shows an input-output balance of the waste incineration plant Wels related to one tonne of waste.

Input related to 1 t waste		Output related to 1 t waste	
Electricity	130 kWh	Electricity	599 kWh
Natural gas	4.5 m <sup>3</sup>	Steam (p = 40 bar; T = 400 °C)	3.15 t
Fresh water	850 l	Slag	274 kg
Lime	6.4 kg	Ferrous scrap	17.2 kg
Sodium hydroxide, 30 %	3.0 kg	Fly ash	35 kg
Ammonia, 25 %	1.4 kg	Filter cake (28 % H <sub>2</sub> O)	2.25 kg
Coke	1.2 kg	Gypsum	4.7 kg
Polyelectrolyte	0.006 kg	Cleaned waste water	358 l
Hydrochloric acid, 30 %	0.5 kg	Cleaned flue-gas (dry)	5692 Nm <sup>3</sup>
FeCl <sub>3</sub> , 40 %	0.65 kg		
Na <sub>2</sub> S	0.19 kg		

Table 10.59: Input and output of the waste incineration plant Wels (reference year: 2000)

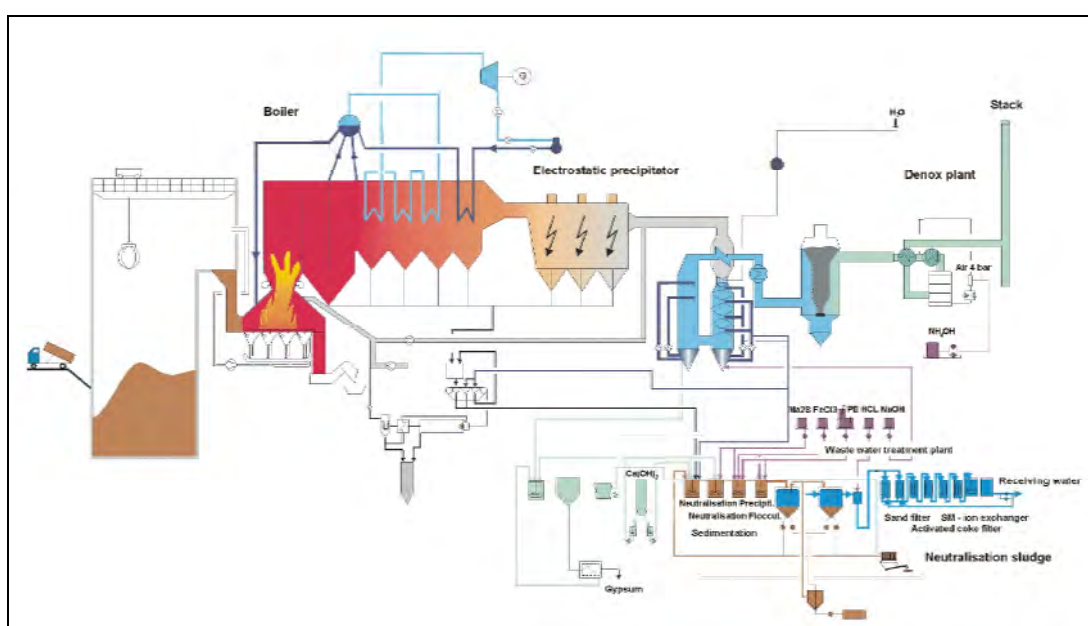

Figure 10.9: Process flow scheme of the waste incineration plant Wels – line 1

### Acceptance, treatment and storage of waste

Waste for combustion is delivered by refuse collection vehicles, weighed and afterwards dumped into the waste bunker that has a capacity of 4600 m<sup>3</sup>. Waste is mixed using a grab crane.

### Waste introduction and supply of combustion air

Every 15 minutes about 2 tonnes of waste are fed from the waste bunker via a slot and a locator onto the combined forward and backward moving grate. The main part of the primary combustion air is sucked off from the waste bunker by a fan and blown through the cooled grate bars into the waste bed lying beyond. When waste with low calorific value is combusted primary air is preheated to enhance combustion and ensure a high combustion temperature.

A part of the cooled flue-gas is withdrawn after the electrostatic precipitator and recirculated into the combustion chamber. Thereby the oxygen content in the flame and thus formation of thermal NO<sub>x</sub> is lowered.

### **Grate firing system**

Combined forward and backward moving grate.

### **Waste heat boiler**

The combustion grate is followed by a boiler system, where flue-gases are cooled from a temperature of 950 °C to 650 °C. Afterwards flue-gases pass the convection zone where their energy content is used for steam production. There their temperature is reduced to 200 °C.

### **Utilisation of energy**

A turbine with a rated power of 7.2 MW produces 45.5 million kWh electricity (reference year: 2000) which are partly used for covering own needs. The surplus of produced energy is fed into the public electrical system.

### **Flue-gas cleaning system and emissions to the air**

*Electrostatic precipitator:* The major part of dust is separated from the flue-gas by electrostatic precipitation

*Wet flue-gas cleaning:* In the first acid step hydrochloric and hydrofluoric acid as well as mercury compounds and residual dust are absorbed in the acid washing water. The occurring absorption liquor is collected in the lower part of the scrubber. A partial flow of process water is continuously fed into the waste water cleaning system in order to prevent the concentration of pollutants. In the second scrubber SO<sub>2</sub> is removed from flue-gas using lime and sodium hydroxide. A partial flow of circulating water is conducted over a precipitation station where a part of the formed sulphates is precipitated as gypsum.

*Activated coke filter:* In the activated coke filter traces of mercury, organic compounds, HCl and SO<sub>2</sub> are adsorbed to activated coke. A part of the loaded filter material is continuously withdrawn and new activated coke is added.

*Catalyst:* After leaving the activated coke filter flue-gases are reheated to a temperature that is sufficient for catalytic denitrification and oxidation of organic compounds by means of a heat transfer system and a high pressure steam heat exchanger. Nitrogen oxides are reduced by injection of an aqueous solution of ammonia. After cooling flue-gases are routed to the stack.

Emission levels that can be achieved by the described flue-gas cleaning system are presented in Table 10.60.

Parameter	Emission (mg Nm <sup>-3</sup> ) <sup>a</sup>	Total mass (kg yr <sup>-1</sup> ) <sup>b,d</sup>	Specific mass (g t <sup>-1</sup> ) <sup>c,d</sup>
Dust <sup>*</sup>	<0.5	<215.39	<2.85
HCl <sup>*</sup>	<0.1	<43.08	<0.57
HF <sup>*</sup>	<0.05	<21.54	<0.28
SO <sub>2</sub> <sup>*</sup>	<2	<861.55	<11.38
CO <sup>*</sup>	20	8615.53	113.84
NO <sub>x</sub> as NO <sub>2</sub> <sup>*</sup>	54	23261.92	307.37
Pb	<0.002	<0.86	<0.011
Cr	<0.002	<0.86	<0.011
Zn	<0.002	<0.86	<0.011
As	<0.002	<0.86	<0.011
Co	<0.002	<0.86	<0.011
Ni	<0.002	<0.86	<0.011
Cd	<0.002	<0.86	<0.011
Hg	<0.002	<0.86	<0.011
Sb	<0.002	<0.86	<0.011
Cu	<0.002	<0.86	<0.011
Mn	<0.002	<0.86	<0.011
V	<0.002	<0.86	<0.011
Sn	<0.002	<0.86	<0.011
Tl	<0.002	<0.86	<0.011
Se	<0.002	<0.86	<0.011
Σ HC <sup>*</sup>	<1	<430.77	<5.69
NH <sub>3</sub>	3.5	1507.72	19.92
PCDD + PCDF (I-TEF)	0.003 ng Nm <sup>-3</sup>	1.29 mg yr <sup>-1</sup>	0.017 µg t <sup>-1</sup>

<sup>\*</sup> Continuous measurement  
<sup>a</sup> Half hourly average values in mg Nm<sup>-3</sup>; dioxin emissions are given in ng Nm<sup>-3</sup> (11 % O<sub>2</sub>; dry flue-gas; standard conditions)  
<sup>b</sup> In kg yr<sup>-1</sup>, dioxin loads in mg yr<sup>-1</sup>  
<sup>c</sup> Emissions related to one tonne used waste in g t<sup>-1</sup>; dioxin emissions in µg t<sup>-1</sup>  
<sup>d</sup> Total mass and specific emissions are calculated based on average half hourly mean values, using the quantity of dry flue-gas (5692 Nm<sup>3</sup> t<sup>-1</sup><sub>waste</sub>) and the waste quantity (75681 t yr<sup>-1</sup>).

**Table 10.60: Emissions to air from the waste incineration plant Wels (reference year: 2000)**  
**Waste water treatment and emissions to water**

The waste water treatment plant consists of a precipitating zone (neutralisation, precipitation, flocculation, sedimentation and sludge dewatering) and a filter zone, which has been erected in two lines (two-layer filter, activated coke filter, ion exchanger, pure water filter). The parameters of cleaned waste water are shown in Table 10.61. The cleaned waste water is released into the receiving water.

Parameter	Measured value (mg l <sup>-1</sup> )
Temperature	<30 °C
pH value	6.8 <pH <9.0
Undissolved compounds	<25
Settleable solids	<0.2
Salt content	<35 g l <sup>-1</sup>
As	<0.05
Cd	<0.05
Chlorides (Cl)	<20 g l <sup>-1</sup>
Cyanides	<0.05
Cr	<0.1
Cu	<0.3
Fluorides (F)	<10
Hg	<0.01
NH <sub>4</sub> – N	<8
Nitrate (NO <sub>3</sub> )	<40
Nitrite (NO <sub>2</sub> )	<8
Ni	<0.5
Pb	<0.1
Sulphate (SO <sub>4</sub> )	<1200
Sulphides	<0.1
Sulphites	<8
Zn	<0.5
AOX/EOX	<0.1
Total HC	<3
Volatile chlorinated hydro carbons	<0.1
Saponifiable fats and oils	<4

**Table 10.61: Waste water parameters of the waste incineration plant Wels after waste water treatment (reference year: 2000)**

## Waste

*Slag:* Slag is washed with water and landfilled.

*Gypsum:* Gypsum occurring by desulphurization is dewatered and landfilled.

*Ash:* Ash that occurs in the electrostatic precipitators is conveyed to a silo for fly ash where it is intermediate-stored before wet chemical treatment.

Slag, ash and gypsum are landfilled.

*Ferrous scrap:* Ferrous scrap is separated from slag and delivered to a scrap dealer.

*Sludges:* Sludges that occur during waste water treatment are dewatered using a chamber filter press, filled into “big bags” and disposed of underground.

### 10.3.1.4 Grate incinerator with SNCR de-NO<sub>x</sub>, combined double filtration and wet scrubbing

Capacity approx. 320000 tonnes/yr

2 incineration lines at 23 t/h each

Central flow furnace with multi-step feed grate

Incineration temperature 850 °C at a residence time >2 seconds

Start-up: 1999

### Reduction of emissions into the air

The waste gas cleaning system consists of the following components:

- SNCR
- Boiler dust deposition
- Tissue filter as current flow adsorber (adsorption of dioxins/furans on hearth furnace coke (HFC))
- 2-stage HCl scrubber
- SO<sub>2</sub> scrubber
- Tissue filter with HFC metering for the adsorption of remaining dioxins, furans and heavy metals.

Waste gas quantity line 1 76137 m<sup>3</sup>/h  
line 2 78464 m<sup>3</sup>/h

Manufacturer: L & C Steinmüller GmbH

Parameter	Measure	Half-hour average value	Daily average value	Annual average value
<b>Continuous measurement</b>				
Total dust	mg/m <sup>3</sup>	<5	<2.5	0.4
HCl	mg/m <sup>3</sup>	<10	<5	0.1
SO <sub>x</sub>	mg/m <sup>3</sup>	<50	<20	2.44
NO <sub>x</sub>	g/m <sup>3</sup>	<0.280	<0.12	0.082
Total C	mg/m <sup>3</sup>	<15 <sup>1</sup>	<7	0.5
CO	mg/m <sup>3</sup>	<60 <sup>1</sup>	<20	8.0
<b>Periodic measurement</b>				
HF	mg/m <sup>3</sup>	<0.06	-	0.03
NH <sub>3</sub> <sup>3)</sup>	-	-	-	-
Cd, Tl	mg/m <sup>3</sup>	<0.001	-	0.0006
Hg <sup>2)</sup>	µg/m <sup>3</sup>	<1	-	0.5
Σ Sb, As, Pb, Cr, Co, Cu, Mn, Ni, V, Sn	mg/m <sup>3</sup>	<0.014	-	0.0081
PCDD/PCDF, I-TE	ng/m <sup>3</sup>	<0.011	-	0.0023
<sup>1)</sup> higher values only for a short time with starts/stops at low temperatures (only gas furnace) <sup>2)</sup> continuous measurement behind the 1 <sup>st</sup> tissue filter, emission measurement repeated <sup>3)</sup> Individual measurement <1 mg/m <sup>3</sup> In all measurements, 100 % of the values specified were complied with.				

**Table 10.62: Average values measured in clean gas (operating values)**

### Reduction of emissions into the water

Waste water from waste gas cleaning undergoes indirect condensation. Thus, the plant is operated with zero waste water discharge. The raw acid from the hydrochloric acid scrubber is upgraded to 30 % hydrochloric acid in a hydrochloric acid reprocessing plant. Mixed salts are used in liquid form (brine) as stowing material in salt caverns. The plaster from the SO<sub>2</sub> scrubber is processed in the building industry.

**Residues**

Quantity of slag: 86000 t/yr (260 kg/t waste)  
 Reprocessing of slag: washing, crushing, metal separation, sifting  
 Further use: Utilization, e.g. in road construction  
 Quality: (see table below)

<b>Solid matter values:</b>	
TOC	<1 %
Loss on ignition	<3 %
PCDD/PCDF	<10 ng I-TE/kg
<b>Eluate values:</b>	
Cl <sup>-</sup>	<100 mg/l
SO <sub>4</sub> <sup>2-</sup>	<350 mg/l
As	<0.006 mg/l
Cd	<0.0005 mg/l
Cr	<0.05 mg/l
Cu	<0.1 mg/l
Hg	<0.0002 mg/l
Ni	<0.004 mg/l
Pb	<0.02 mg/l
Zn	<0.01 mg/l

**Table 10.63: Slag quality****Energy utilization (reference year 2000)**Heat generation/output

Heat generation in total: 3009893 GJ/yr  
 Internal consumption: 800925 GJ/yr  
 Heat output to thermal power plant: 1346577 GJ/yr

Steam generation/output

Steam DE1: 493105 t  
 Steam DE2: 488834 t  
 Steam HDE3: 25458 t  
 Steam HDE4: 33908 t  
 Steam output to thermal power plant: 461756 t

Electric power generation/output:

Electric power generation in total: 59213 MWh  
 Internal consumption (incl. additional supplies of approx. 7398MWh): 36715 MWh  
 Electric power output: 29896 MWh

Waste quantity combusted: approx. 318000 t		Energy in (MWh)		Energy efficiency ratio in (%)		
		El power	Heat	El. Power	Heat	Total
	generated	59213	526000	7/9.3 <sup>7</sup>	66/88 <sup>1</sup>	73/97.3 <sup>1</sup>
released	29896	344000	4/5.3 <sup>1</sup>	42/56 <sup>1</sup>	46/61.3 <sup>1</sup>	

<sup>1</sup> Energy utilization factor, taking into account a combustion efficiency of >75 % of the energy input into the waste.

**Table 10.64: Energy efficiency ratio (assumed average calorific value ≈ 9500 kJ/kg)**



## Costs

- Investment costs (incl. planning and 50000000 DM for infrastructure measures): approx.  $450 \cdot 10^6$  DM
- Specific treatment costs: approx. 250 DM/t (plus VAT)

### 10.3.1.5 Grate incinerator with semi-wet FGT, active carbon injection, ash recirculation, bottom ash treatment and (mainly) electricity generation

#### GENERAL INFORMATION

The plant is situated on the Island of Mallorca. The waste treated are municipal solid waste and occasionally sewage sludge. Flexible design to wide range of LCV in urban waste and to adapt to changes in selective collection.

Of note are:

- control of incoming waste (providers, origin and types of waste) and sub-products
- water management efficiency - agreement with neighbouring industrial installation to re-use external waste water in the process
- contribution to an isolated energy system (island)
- measures to avoid/eliminate smell and leaching
- certified environmental and quality management system.

#### DESIGN/CONSTRUCTION DATA

Combustion technique : 2 x 18.75 t<sub>w</sub>/h, Roller type (DBA) 20° Inclination Dusseldorf Grate

Plant capacity : 300000 t/yr; LCV range : 6575 - 8666 kJ/kg;

Design thermal input to the grate : 2 x 45.14 MW

Steam boiler, 42 bar, 400 °C; horizontal design, four superheaters, three economisers.

Energy valorisation : Electricity for export and internal use, steam for internal use only.

Turbo-generator : 34.1 MW (design to accept steam from a 3<sup>rd</sup> line which is now under project)

FGT system (Flue-gas Treatment) : Semi-wet process, with active carbon injection, ash recirculation.

De-dusting by Bag House Filter. Semi-wet scrubber, atomizer with lime milk injection. De-diox by Active Carbon injection. De-NO<sub>x</sub> (and additional de-diox) by SCR (contracted : installation 2004 – 2005).

No aqueous effluents are discharged from the plant

Bottom ash treatment : quenched and directed to a segregation plant in which it is separated into three main fractions: Ferrous Metals, Non Ferrous Metals and Inerts. Ageing area for the inerts

FGT solid residues : Fly ash stabilised with special cement and landfilled in a "safety deposit"

Material valorisation : Bottom ash used for road construction, cement production and as a substitute for other construction materials when appropriate. Ferrous and non-ferrous metals sold to the local market.

Re-use of stabilized APC residues under investigation.

Start-up : 1996 (test trials), official March 1997.

Complies with the WID-2000 (Waste Incin. Directive) except de-NO<sub>x</sub>. SCR de-NO<sub>x</sub> system under contracting, to be in operation in 2005.

**OPERATING DATA**

Year of reference for the following data: 2003

Waste throughput 300739 t/yr municipal solid waste.

Average NCV: 7760 kJ/kg

Working hours including partial load hours (availability) : Line 1: 7984/8760 hr/Line 2: 7975/8760 hr.

Main maintenance turn down in November (done every 15 – 18 months)

Reagents consumption : CaO : 2684 t/yr // Activ. Carbon : 280 t/yr // Crude Water : 93982 t/yr.

Imported electricity: 1082 MWh/yr (only during yearly shutdown for maintenance). No heat imported.

Electricity consumption : 22809 MWh/yr.

Energy output : 154 GWh/yr

Material residues : Cemented Fly Ash : 21020 t/yr

Annual average of continuous concentrations measurement in clean gas :

Total dust : 1.2 mg/Nm<sup>3</sup> // HCl : 5.3 mg/Nm<sup>3</sup> // HF <0.1 mg/Nm<sup>3</sup> // SO<sub>x</sub> as SO<sub>2</sub> (data 2004): 6.5 mg/Nm<sup>3</sup>

// TOC : 1.8 mg/Nm<sup>3</sup> // CO : 1.9 mg/Nm<sup>3</sup> // NO<sub>x</sub> : 280 mg/Nm<sup>3</sup>.

Average value of concentration samplings in clean gas (periodic measurement of substances listed in the WID-2000), 8 samplings :

Cd : <0.008 mg/Nm<sup>3</sup> // Tl : <0.008 mg/Nm<sup>3</sup> // Cd + Tl : <0.016 mg/Nm<sup>3</sup> // Hg : <0.0005 mg/Nm<sup>3</sup> // Sb :

<0.01 mg/Nm<sup>3</sup> // As : <0.025 mg/Nm<sup>3</sup> // Pb : <0.02 mg/Nm<sup>3</sup> // Cr : <0.009 mg/Nm<sup>3</sup> // Co : <0.01 mg/Nm<sup>3</sup>

// Cu : <0.015 mg/Nm<sup>3</sup> // Mn : <0.05 mg/Nm<sup>3</sup> // Ni : <0.009 mg/Nm<sup>3</sup> // V : <0.009 mg/Nm<sup>3</sup>

Sb + As + Pb + Cr + Co + Cu + Mn + Ni + V : <0.16 mg/Nm<sup>3</sup>

PCDD/F (4 samplings): <0.005 ng<sub>iteq</sub>/m<sup>3</sup>

**ECONOMICS**

Investment cost 90 million Euros financed by the European Investment Bank

Gate fee : 75 Euros/tonne. This fee is the fee per tonne entering in the integrated waste management scheme which includes management of transfer stations, separation of packaging residues, composting and anaerobic digestion for organic fraction, bottom ash recycling, stabilization/solidification of ashes and APC residues and safety landfill for stabilized residues. It is the result of the local decision to favour recycling schemes and therefore all the costs of the integrated management are supported by the incineration fee. Municipalities do pay ZERO euros for composting and recycling options.

### 10.3.1.6 Grate incinerator with SNCR de-NO<sub>x</sub>, semi-wet FGT, active carbon injection and high steam parameters (60 bar/380 °C) electricity generation

**GENERAL information**

Municipal authority (Final customer) and the Owner of the plant : Consorci per al Tractament de residus sòlids urbans del Maresme

Operator : Tractament i Revalorització de Residus del Maresme, S.A.

The plant treats Municipal Solid Waste

On this plant, it is worth noting the high steam characteristics (60 bar)

**DESIGN/CONSTRUCTION DATA**

Combustion technique : Reverse acting reciprocating grates, 2 x 10 t/h

Plant capacity : 165000 t/yr; LCV range : 5440 - 12560 kJ/kg; nominal : 8375 kJ/kg.

Design thermal input to the grate : 2 x 23.2 MW

Steam boiler, 60 bar, 380 °C; vertical design, 5 passes.

Energy valorisation : Electricity for export and internal use, steam for internal use only.

Turbo-generator : 11.25 MW

FGT system (Flue-gas Treatment) : Semi-wet process, with active carbon injection, and SNCR.

SNCR de-NO<sub>x</sub> (urea). De-dusting by Bag House Filter. Semi-wet scrubber, with upstream injection of lime milk and active carbon (separately) + (added) Contact (Dry) Reactor (Ca(OH)<sub>2</sub>) with recirculation of ashes from the BHF. De-diox by Active Carbon injection after the Semi-wet scrubber.

No aqueous effluent from the FGT. Other waste water treatment (by precipitation) and release to the sewer.

Bottom ash treatment : quenched scrap ferrous metals removal, recovered for road construction

FGT solid residues : Fly ash stabilisation and landfilling.

Material valorisation : Bottom ash used for road construction. Ferrous metals recovered.

Start-up : 1994 (grates, boilers, semi wet FGT), 2000 (Active carbon), 2004 (SNCR + Dry (Contact reactor) Ca(OH)<sub>2</sub>).

**OPERATING DATA**

Year of reference (for the following data) : 2003  
 Waste throughput : 163.362 t/yr. Municipal solid waste 96 %, Industrial waste 4 %  
 Average NCV: 8820 kJ/kg  
 Working hours including partial load hours (availability) : L1: 8319/8760 h, L2: 8424/8760 h.  
 Reagents consumption : Ca(OH)<sub>2</sub> : 1844 t/yr // NaOH: 54.2 t/yr // HCl : 20.3 t/yr // Activated carbon : 148 t/yr // Urea N<sub>2</sub>H<sub>4</sub>: 720 kg/yr // Fresh water : 62144 m<sup>3</sup>/yr.  
 Imported electricity: 1547 MWh/yr (only during yearly shutdown for maintenance).  
 Energy consumption : Electricity 10930 MWh, Natural gas: 68367 Nm<sup>3</sup>/yr  
 Energy output : Electricity: 61690 MWh.  
 Material recovery : Bottom ash for road construction: 40394 t/yr. Ferrous metals : 833 t/yr  
 Material residues : Fly Ash: 6261 t/yr  
 Annual average of continuous concentrations measurement in clean gas :  
 // HCl : 26 mg/Nm<sup>3</sup> // PST : 9 mg/Nm<sup>3</sup> // CO : 13 mg/Nm<sup>3</sup>  
 Average value of concentration samplings in clean gas (periodic measurement) :  
 TOC: 11.66 mg/Nm<sup>3</sup> // HF: 0.071 mg/Nm<sup>3</sup> // SO<sub>2</sub>: 22.06 mg/Nm<sup>3</sup> // Cd+Hg: 0.0178 mg/Nm<sup>3</sup> // Ni+As: 0.0385 mg/Nm<sup>3</sup> // Pb+Cr+Cu+Mn: 0.2499 mg/Nm<sup>3</sup> // NO<sub>x</sub>: 237.59 ppm  
 PCDD/F : 0.0462 ng<sub>iteq</sub>/m<sup>3</sup>  
 Concentrations in cleaned waste water : Total suspended solids : 33 mg/l // Cd : <0.05 mg/l // Pb : <0.5 mg/l // Zn : <0.5 mg/l // pH value : 8 // P : 8 mg/l.

**10.3.1.7 Grate incinerator with SNCR (NH<sub>3</sub>), semi-wet lime, active carbon and electricity generation****GENERAL information**

The plant is in South East London, UK. Owned by SELCHP Ltd and operated by Onyx SELCHP Ltd  
 It's worthy noting of : ISO 9001 and ISO 14001. Investors in People (IIP). Project financing. High electricity generation. Big plant.  
 The waste is municipal solid waste

**DESIGN/CONSTRUCTION DATA**

Combustion technique : 2 x 29 t<sub>w</sub>/h, Reverse acting Reciprocating grate.  
 Plant capacity : 420000 t/yr; LCV range : 7500 to 10000 kJ/kg;  
 Design thermal input to the grate : 2 x 68.5 MW  
 Steam boiler, 45 bar, 395 °C; Vertical design, 4 passes.  
 Energy valorisation : Electricity for export and internal use, steam for internal use only.  
 Turbo-generator : 35 MW  
 FGT system (Flue-gas Treatment) : SNCR Semi-wet process with active carbon injection.  
 De-dusting by Bag House Filter. Semi-wet scrubber with lime milk from quick lime. De-diox by Active Carbon injection before the semi-wet scrubber. SNCR de-NO<sub>x</sub> (ammonia water).  
 No aqueous effluent discharged from the plant  
 Bottom ash treatment : quenched, scrap ferrous metals removal, ash stored for ageing, scrap non ferrous removal. Max 110000 tonnes per year.  
 FGT solid residues : APC Residues: 12500 t/yr mixed with water and landfilled.  
 Material valorisation : Bottom ash used for road construction. Ferrous and non-ferrous metals.  
 Start-up : 1994.  
 Complies with the WID-2000 emission limits except for NO<sub>x</sub> and HCl. Enlarged baghouse and some work to SNCR to comply by 12/2005

## OPERATING DATA

Reference year (for the following data) : 2003

Waste throughput : 404000 t/yr, 100 % municipal waste.

Average NCV : 9250 kJ/kg

Working hours (availability) including partial load hours: line 1 : 8 403 h/yr; line 2 : 7 812 h/yr

Reagents consumption : Quick lime: 3 876 t/yr // Caustic Soda: 45.75 t/yr // Activ. Carbon: 79 t/yr //

Hydroc. Acid: 57 t/yr // Ammonia: 997 t/yr.

Energy input: Imported electricity : 274 MWh // Fuel : 457 427 litres

Energy consumption : Electricity: 66 kWh/t of waste

Electricity output : 243 GWh generated, 216 GWh exported

Material recovery : Bottom ash: 111 000 t/yr // Ferrous metals: 9 300 t/yr

Material residues : FGT residues: 12 500 t/yr

Concentrations in clean gas (continuous measurement). Annual average, plus maximum 1/2 hour average and max daily average :

SO<sub>2</sub>: 8.2/<30/<60 mg/Nm<sup>3</sup>

HCl: 13.4/11.5/<40 mg/Nm<sup>3</sup>

CO: 6.2/<12/<65 mg/Nm<sup>3</sup>

Dust: 1.2/<10/<20 mg/Nm<sup>3</sup>

NO<sub>x</sub>: 282/<320/<380 mg/Nm<sup>3</sup>

TOC: 1.2/<2/<15 mg/Nm<sup>3</sup>

Concentrations in clean gas (periodic measurement). Average value:

Hg + Cd: 0.003 mg/Nm<sup>3</sup> // Dioxins: 0.004 ng/Nm<sup>3</sup> // Total other metals : 0.019 mg/Nm<sup>3</sup>

## ECONOMICS

Investment costs : GBP 100 million, including GBP 15 million construction finance.

Gate fee : Average GBP 35 per tonne. Electricity selling price all up around GBP 27 per MW hour.

### 10.3.1.8 Grate incinerator with SNCR (NH<sub>3</sub>), semi-wet lime, active carbon and electricity generation

#### GENERAL information

The plant is owned by Hampshire Waste Services Ltd and operated by Onyx Hampshire Ltd. The municipal authority (final customer) is Hampshire County Council, UK.

Waste type : Municipal solid waste only.

Of particular note :

- Award-winning architecture
- Part of a major integrated municipal waste contract, with enhanced recycling & composting
- Project financing

**DESIGN/CONSTRUCTION DATA**

Combustion technique : Reverse acting Reciprocating grate, 1 x 12 t/h

Plant capacity : 90000 t/yr; LCV range : 6990 - 12500 kJ/kg; nominal : 9200 kJ/kg

Design thermal input to the grate : 1 x 30.67 MW

Steam boiler, 45 bar, 395 °C; vertical design, 4.5 passes.

Energy valorisation : Electricity for export and internal use, steam for internal use only.

Turbo-generator : 8 MW

FGT system (Flue-gas Treatment) : Semi-wet process with active carbon injection, SNCR.

SNCR de-NO<sub>x</sub> (urea). De-dusting by 1 BHF (Bag House Filter). Semi-wet scrubber with lime milk from quick lime. De-diox by Active Carbon injection before the BHF.

No aqueous effluent from the plant under steady state conditions.

Bottom ash treatment : quenched, scrap ferrous metals removal.

FGT solid residues : Dampened & landfilled as special waste. Mid 2005 : secondary processing planned using waste acids to give non-hazardous filter cake

Material valorisation : Bottom ash - mid 2005 plant planned for non-ferrous extraction & secondary aggregate production.

Start-up : 2003.

reported to comply with the WID-2000 since start up, but some procedural issues to be resolved with Regulator

**OPERATING DATA**

Reference year (for the following data) : Design/2004/2005 forecast

Waste throughput : 90000 t/yr; 100 % municipal waste

Average NCV : 9100 kJ/kg est.

Working hours (availability) including partial load hours : 87.80 %

Reagents consumption : Quick lime : 10 kg/t<sub>w</sub> // Urea : 1.25 kg/t<sub>w</sub> // Activated carbon : 0.25 kg/t<sub>w</sub> // Fresh water : 0.25 t/t<sub>w</sub>.

Energy input: Imported electricity : 340 MWh electricity// Fuel oil: 80000 t

Energy consumption : Elec: 70 kWh/t of waste

Electricity output : 0.5 MWh/t

Material recovery : Bottom ash: 25 % // Ferrous metal: 2 %

Material residues : FGT residues: 35 kg/t

Average concentrations in clean gas (continuous measurement) :

CO: 4.7 mg/Nm<sup>3</sup> // HCl: 8.1 mg/Nm<sup>3</sup> // VOCs: 0.4 mg/Nm<sup>3</sup> // NO<sub>x</sub>: 177 mg/Nm<sup>3</sup> // SO<sub>2</sub>: 7.5 mg/Nm<sup>3</sup> // TPM: 4.2 mg/Nm<sup>3</sup>.

Concentrations in clean gas (periodic measurement of substances listed in the WID-2000)

Cd+Tl: 0.0002 mg/Nm<sup>3</sup> // Hg: 0.009mg/Nm<sup>3</sup> // Total other heavy metals: 0.02 mg/Nm<sup>3</sup> // Dioxins: 0.00882 ng/Nm<sup>3</sup>.

Concentrations in clean gas (periodic measurement of substances not listed in the WID-2000) : NH<sub>3</sub>: 0.7 mg/Nm<sup>3</sup>.

**ECONOMICS**

Investment costs : GBP 30 – 35 million, depending on assumptions

Gate fee : Internal cost centre - no gate fee

### 10.3.2 Examples of the hazardous wastes installations

#### 10.3.2.1 Rotary kiln with heat recovery, SNCR, EP, wet scrubber and static coke filter

Two rotary kilns of the Plant Simmeringer Haide are operated for incineration of hazardous wastes. In the year 2000, 89964 tonnes of wastes were combusted. A detailed list of treated types of waste and quantities is given in Table 10.65.

Types of waste	Waste quantity (t yr <sup>-1</sup> )
Waste oil	9521
Oil-water mixture, oil content 85 – 100 %	28
Oil-water mixture, oil content 50 – 85 %	1655
Oil-water mixture, oil content <50 %	6384
Oil-water mixture, oil content <10 % which can be separated	759
Separator content	1216
Other waste, internal waste	1902
MA 48; collection of hazardous waste	1059
Liquid organic waste	10703
Solid or pasty organic waste	11100
Liquid inorganic waste	10005
Solid or pasty inorganic waste	328
Oil contaminated soil	115
Trade and industrial waste	16308
Hospital waste	2360
Old medicines	768
Herbicides	802
Hazardous household waste	2
Chemically contaminated soil	56
Laboratory waste	344
Biofilter from the main WWTP Vienna, residual waste	3256
Screening DRO	5008
Sand and crushed stone, canal waste	4829

**Table 10.65: Types of waste and waste quantities incinerated in the rotary kilns of Plant Simmeringer Haide (reference year: 2000)**

General data of the two rotary kilns of the Plant Simmeringer Haide are shown in Table 10.66.

Rotary kilns of the Plant Simmeringer Haide	
Operator	Fernwärme Vienna GmbH
Years of commissioning	1980
Firing technology	rotary kiln
Waste throughput	89964 t
Theoretical rated thermal input	50 MW
Working hours line 1	6.782
Working hours line 2	7.423

**Table 10.66: General data of the rotary kilns of the Plant Simmeringer Haide (reference year: 2000)**

## Plant concept

A process flow diagram of one of the rotary kilns is shown in Figure 10.10. Each combustion line basically consists of the following units:

- delivery and acceptance zone
- firing system: Rotary kiln (length: 12 m, outer diameter 4.5 m, rotations per minute: 0.1–0.6)
- waste heat boiler
- flue-gas cleaning devices: SNCR process, electrostatic precipitator, four-stage wet scrubber, activated coke filter
- multistage waste water treatment plant
- steam distribution system.

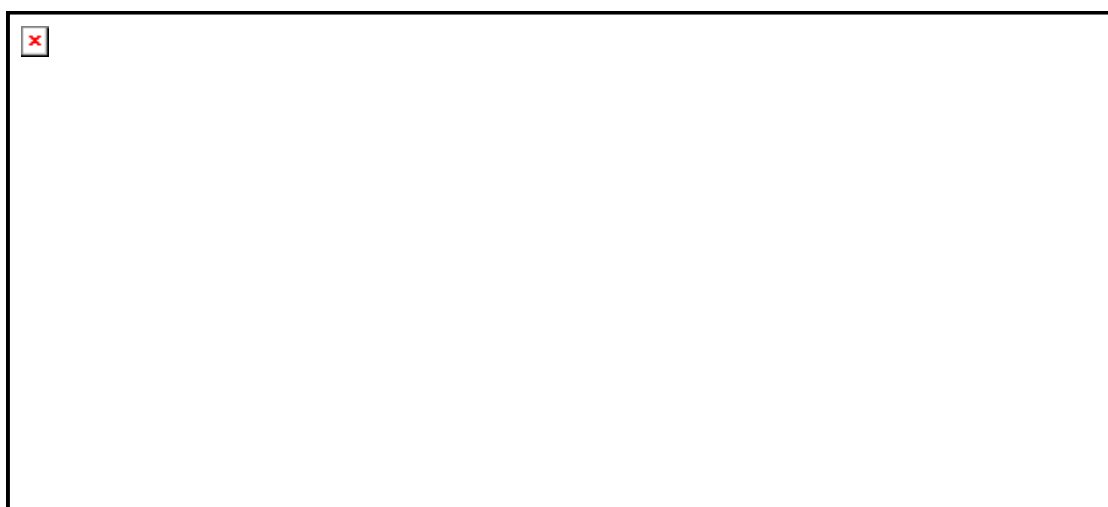

**Figure 10.10: Process flow scheme of the rotary kilns of the Plant Simmeringer Haide**

Table 10.67 presents an input/output balance of the rotary kilns of the Plant Simmeringer Haide related to one tonne of waste.

Input related to 1 t waste		Output related to 1 t waste	
Electricity	234 kWh	Heat	1459 kWh
Fresh water	6158 l	Electricity	269 kWh
Heavy fuel oil, 1 % S	0.033 m <sup>3</sup>	Steam (p = 52 bar; T = 350 °C)	3.7 t
Lime	23.2 kg	Slag	190 kg
Coke	5.0 kg	Metal scrap	13.4 kg
Sodium hydroxide, 50 %	5.2 kg	Fly ash	14.6 kg
Ammonia, 25 %	3.0 kg	Filter cake (54.7 % H <sub>2</sub> O)	17 kg
Precipitating agents, 15 %	0.32 kg	Cleaned waste water	1657 l
FeCl <sub>3</sub> , 40 %	1.53 kg	Cleaned flue-gas (dry)	7900 Nm <sup>3</sup>
Hydrochloric acid, 30 %	1.0 kg		
Sand	35.6 kg		
Liquid nitrogen, 98.5 %	3.6 kg		

**Table 10.67: Input and output flows of the rotary kilns of the Plant Simmeringer Haide (reference year: 2000)**

### **Acceptance, treatment, storage and introduction of waste**

After delivery hazardous wastes are visually examined whereby the accordance with accompanying documents is verified. Afterwards chemical and physical parameters according to ÖNORM S2110 (1991) are determined. On the basis of analysis results waste fractions are evaluated, intermediately stored, mixed according to existing “recipes” and fed into the rotary kiln.

*Solid Waste:* Solid waste is delivered in containers and vats by trucks and dumped into the waste bunker. Waste from the waste bunker is directly supplied either to the combustion process over a feeding chute or is homogenised first.

*Liquid Waste:* Liquid waste is delivered in tank lorries and stored depending on their properties. Combustible liquids are either directly supplied to the combustion process or after previous mixing using combustion lances.

*Container:* Containers are intermediately stored, sorted and directly supplied to the combustion process or to the homogenization process using roller conveyors and lifts

*Infectious clinical waste:* This waste fraction is delivered in sealed plastic containers, intermediately stored and supplied to the combustion chamber by a fully automatic conveyor.

### **Supply of combustion air**

Combustion air is sucked off from the bunker and supplied to the rotary kiln over the front wall as primary air and over the afterburning chamber as secondary air.

### **Rotary kilns with afterburning chamber**

The steel tubes are refractory lined and have a length of 12 meters and an outer diameter of 4.5 m. Waste is mixed by slow rotation (0.1 - 0.6 rotations per minute), transported through the rotary kiln and combusted at a temperature of about 1200 °C.

Flue-gases of the rotary kiln are fully combusted in the afterburning chamber. If the combustion temperature in the afterburning chamber falls below 1200 °C two side wall burners using extra light and heavy fuel oil can be additionally switched on. In the middle respective upper end of the afterburning chamber secondary and tertiary air is injected.

### **Utilisation of energy**

Electricity is produced to cover the own needs of the Plant Simmeringer Haide. Additionally heat is fed into the remote district heating system of Vienna.

### **Flue-gas cleaning system and emissions to the air**

*Electrostatic precipitator:* In this first flue-gas cleaning step dust emissions are reduced to 10 - 30 mg/Nm<sup>-3</sup>.

*Wet flue-gas cleaning:* The wet flue-gas cleaning system consists of two cross flow scrubbers for separation of acid, water soluble gases as well as dust and heavy metals. The subsequent venturi scrubber is operated for separation of fine dust and for preconditioning of flue-gases for the electrodynamic venturi scrubber.

*SNCR:* Nitrogen Oxides are reduced by injection of an aqueous solution of ammonia into the flue-gas.



*Activated coke filter:* Post-treatment takes place in a countercurrent plant using activated coke separately for each combustion line. This unit consists of two parallel arranged adsorbers that are filled with lignite-furnace coke. The adsorbers for the rotary kilns consist of 8 modules each, whereby each module is filled with 15 t adsorbent. Flue-gas flows through the layer from the bottom up while the coke slowly moves downwards.

Using these flue-gas cleaning system emission levels shown below are achieved:

Parameter	Emission (mg Nm <sup>-3</sup> ) <sup>a</sup>	Total mass (kg yr <sup>-1</sup> ) <sup>b, d</sup>	Specific emissions (g t <sup>-1</sup> ) <sup>c, d</sup>
Dust <sup>*</sup>	<0.05	35.54	0.395
HCl <sup>*</sup>	0.42	298.5	3.318
HF	<0.05	35.54	0.395
SO <sub>2</sub> <sup>*</sup>	1.2	852.86	9.48
CO <sup>*</sup>	33	23453.61	260.7
NO <sub>x</sub> as NO <sub>2</sub> <sup>*</sup>	104	73914.42	821.6
Cr	0.0005	0.35	0.004
As	<0.0001	0.071	0.00079
Ni	0.0003	0.21	0.0024
Cd	0.0003	0.21	0.0024
Hg	0.0014	0.995	0.011
Cu	0.0005	0.35	0.004
C <sub>org</sub> <sup>*</sup>	2.2	1563.58	17.38
NH <sub>3</sub>	1.9	1350.36	15.01
PCDD+PCDF	0.00154 ng Nm <sup>-3</sup>	1.1 mg yr <sup>-1</sup>	0.012 µg t <sup>-1</sup>
PAH	0.0133	9.45	0.11

\* Continuous measurement  
<sup>a</sup> Half hourly average values in mg Nm<sup>-3</sup>; dioxin emissions are given in ng Nm<sup>-3</sup> (11 % O<sub>2</sub>; dry flue-gas; standard conditions)  
<sup>b</sup> In kg yr<sup>-1</sup>, dioxin loads in mg yr<sup>-1</sup>  
<sup>c</sup> Emissions related to one tonne used waste in g t<sup>-1</sup>; dioxin emissions in µg t<sup>-1</sup>  
<sup>d</sup> Total mass and specific emissions are calculated based on average half hourly mean values, using the quantity of dry flue-gas (7900 Nm<sup>3</sup> t<sup>-1</sup><sub>waste</sub>) and the waste quantity (89964 t yr<sup>-1</sup>).

**Table 10.68: Emissions to air from the rotary kilns of the Plant Simmeringer Haide (reference year: 2000)**

### Waste water treatment and emissions to water

Waste water from both rotary kilns is pre-cleaned together with those of the three fluidised bed reactors. Afterwards it is conducted into the main sewage treatment plant of Vienna. Waste water cleaning is performed using gravity separation, neutralisation, flocculation, filtration and precipitation processes.

Using these cleaning steps emission levels shown below are achieved:

Parameter	Measured value (mg l <sup>-1</sup> )
Temperature	<30 °C
Electric conductivity	24.6 mS cm <sup>-1</sup>
pH value	9.2
Undissolved compounds	10
As	<0.02
Ca	3.86 g l <sup>-1</sup>
Cd	0.019
Chlorides (Cl)	8.86 g l <sup>-1</sup>
Cyanides	<0.1
Cr	0.01
Cu	0.01
Fluorides (F)	5.2
Hg	0.001
NH <sub>4</sub> – N	63
Nitrate (NO <sub>3</sub> )	50
Ni	0.01
Pb	<0.02
Sulphate (SO <sub>4</sub> )	912
Sulphides	<0.01
Sulphites	<5
Zn	0.05
AOX/EOX	0.01
Phenol	0.11
Sb	0.047
Tl	0.02
V	0.01

**Table 10.69: Waste water parameters of the rotary kilns of the Plant Simmeringer Haide after waste water treatment (reference year: 2000)**

## Wastes

*Slag and filter ash:* Slag and filter ashes are landfilled.

*Filter cake:* The filter cake from the waste water cleaning plant is filled into “big bags” and landfilled.

*Ferrous scrap:* Separated ferrous metals are delivered to a scrap dealer.

*Activated coke:* Loaded activated coke is removed into a silo by conveying installations and combusted internally.

Chemical data of waste fractions from the rotary kilns are shown in Table 10.70

Parameter	Measured value		
	Slag	Fly ash	Filter cake
TOC (%) (air dried basis - ad)	2.22	2.19	
Cl (%) (ad)		3.4	
SO <sub>3</sub> (%) (ad)		21.4	
<b>Main components (mg kg<sup>-1</sup>) (dry basis)</b>			
SiO <sub>2</sub>	40.9 %	12.2 %	2.9 %
Al	22217	13576	3308
MgO	3.1 %	1.4 %	0.5 %
Fe	97815	46928	26619
CaO	12.1 %	8.2 %	31.4 %
Na <sub>2</sub> O		17.9 %	
K <sub>2</sub> O	1.1	5.3	<0.4
<b>Heavy Metals (mg kg<sup>-1</sup>) (dry basis)</b>			
Zn	1868	52921	9399
Pb	802	25162	1062
Mn	826	1046	467
Cr	643	494	37
Cd	4.4	360	162
As	7.6	142	12
Hg	0.29	0.42	1088
Ni	375	995	83

**Table 10.70: Chemical data of wastes from the rotary kilns (reference year: 2000)**

Results from leaching tests are presented in Table 10.71.

Leached concentrations (mg kg <sup>-1</sup> )	Slag	Fly ash	Gypsum
pH value	11.0	6.6	8.5
SO <sub>4</sub>	90	18717	1441
Cl	30	5260	624
NH <sub>3</sub> as N	0.29	0.65	1.73
NO <sub>3</sub>	4	4.6	5
NO <sub>2</sub>	0.1	0.1	0.8
Fe	0.02	0.02	0.01
Mn	0.02	20	0.19
Ni	<0.1	5.47	<0.1
Cd	0.02	31	0.01
Cr	0.01	0.01	0.01
Cu	0.01	19.2	<0.01
Pb	0.13	9.3	0.1
Zn	0.99	2178	0.18
Hg	<0.001	0.003	<0.001

**Table 10.71: Leaching tests (according to ÖNORM S 2115) rotary kilns of the Plant Simmeringer Haide (reference year: 2000)**

### 10.3.2.2 Rotary kiln with SCR, EP, wet scrubber and static carbon filter

Total capacity 110000 t/yr  
 Drum-type kiln with secondary reaction chamber  
 2 incineration lines of 6.3 t/h each  
 Start-up: 1997

## Reduction of emissions into the air

The waste gas cleaning system consists of the following components:

- Electrostatic filter
- Quench
- HCl absorber (2-step scrubbing)
- SO<sub>2</sub> scrubber (2-step neutralization with lime milk)
- Activated carbon filter
- DeNO<sub>x</sub> -SCR catalyser.

Waste gas per line: 61800 m<sup>3</sup>/h

Manufacturer:

The average values measured in clean gas (operating values) of the plant are listed in the following Table 10.72.

Parameter	Measure	Half-hour average value	Daily average value	Annual average value
<b>Continuous measurement</b>				
Total dust	mg/m <sup>3</sup>			0.2
HCl	mg/m <sup>3</sup>			0.7
SO <sub>x</sub>	mg/m <sup>3</sup>			0.08
NO <sub>x</sub>	g/m <sup>3</sup>			0.075
Total C	mg/m <sup>3</sup>			0.3
CO	mg/m <sup>3</sup>			8.9
Hg	mg/m <sup>3</sup>			0.002
<b>Periodic measurement (average value over sample taking period)</b>				
HF	mg/m <sup>3</sup>			<0.2
Cd, Tl	mg/m <sup>3</sup>			0.0004
Σ Sb, As, Pb, Cr, Co, Cu, Mn, Ni, V, Sn	mg/m <sup>3</sup>			0.009
PCDD/PCDF, I-TE	ng/m <sup>3</sup>			0.005

**Table 10.72: Average values measured in clean gas (operating values)**

## Reduction of emissions into the water

The incineration plant is operated with a zero waste water discharge. The raw acid from the hydrochloric acid scrubber is upgraded to 18 % hydrochloric acid in a chemical-physical reprocessing plant. The plaster from the SO<sub>2</sub> scrubber is reprocessed.

## Energy utilization

With a waste quantity of 69000 t combusted in the year 2000, a heat quantity of 192000 was fed into the existing district heating system.

## Noise emissions/immissions

Distance of plant to site of immission/impact: 500 m

Sound assess level:

L<sub>aeq</sub> = 44.3 dB(A) - short-term (1 minute) events

L<sub>AF</sub> = 56.5 dB(A)

## Costs

- Investment costs (including modernization of the plant): approx. 400m DM
- Specific treatment costs: 400 to 800 DM

### 10.3.2.3 Rotary kiln with SNCR (urea), dry lime FGT, double bag filtration and dioxin absorption

Installation operated by SARP Industries, Limay

#### GENERAL INFORMATION

Hazardous wastes incinerators (2 lines + 1 under construction) owned and operated by SARP Industries.

Waste treated: hazardous wastes, solid, pasty, liquid. Outstanding issues: Cyanide solid and liquids/Organic acid special lines/Odororous wastes injection. High Chlorine input (close to 2 % in weight)

#### DESIGN/CONSTRUCTION DATA

- rotary Kilns (Diameter 2.5m, 3.0m, 3.5m/Length 11m, 11m, 12m)
- secondary Combustion Chamber (200 to 300 m<sup>3</sup>)
- NCV range: -600 to 10 000 kcal/kg (average at 2500 kcal/kg)
- design thermal input: 17 to 20 MW/7 - 8 T/h per line
- permit: 3 x 50 000 T/y
- steam boiler: 6 pass, vertical, 30bar saturated steam
- energy valorisation: steam sold to power plant (heating of fuel tanks)
- FGT system: Conditioning tower (water), Double dry = Reactor 1 + BHF 1 + Reactor 2 + BHF 2, spongiacal lime and dioxorb injection in stage 2 and recycling
- SNCR deNO<sub>x</sub> with solid urea
- consumption: lime 50 kg/tonne HW (stoichiometric ratio 1.5)
- bottom ash: to HW landfill
- FGT residues: BHF dust to stabilisation unit and the HW landfill
- start up: line 1 1985/line 2 1989/line 3 2005
- complies with the WID-2000 directive since 2000 (because of HWID).

#### OPERATING DATA

- year of reference 2001
- waste throughput: 105 000 tonnes
- average NCV: 2200 to 2500 kcal/kg
- working hours: line 1 7259/8760 h/line 2 8208/8760 h
- reagent consumption: Ca(OH)<sub>2</sub> 5000 tonnes/Dioxorb (dediox clay) 540 tonnes
- electricity consumption: 24 332 000 kWh (for the all plant, including, Physico Chemical treatment, Evapo-oxydation unit, Shredding, Stabilisation plant)
- material residues: bottom ash 12 600 tonnes/BHF dust 7 800 tonnes
- annual average of continuous concentration measurement in clean gas (dry 11 % O<sub>2</sub>):
- dust 1.42/1.33 mg/Nm<sup>3</sup> // HCl 0.75/0.60 mg/Nm<sup>3</sup> // SO<sub>2</sub> 5.2/22.7 mg/Nm<sup>3</sup> // TOC 2/0.8 mg/Nm<sup>3</sup> // CO 13.5/15.2 mg/Nm<sup>3</sup> // NO<sub>x</sub> 117/73 mg/Nm<sup>3</sup>
- average values of concentration sampling in clean gas (periodic measurements), 2 samplings:
- sum Sb+As+Pb+Cr+Co+Cu+Mn+Ni+V 0.05/0.34 mg/Nm<sup>3</sup> // Hg 0.002/0.002 mg/Nm<sup>3</sup> // Cd+Tl 0.006/0.004 mg/Nm<sup>3</sup> // PCDD-F 0.022/0.013 ng I-TEQ/Nm<sup>3</sup>.

#### ECONOMICS

Investment costs: line 3 around EUR 27 million

Gate fee: varying from 80 to EUR 1000/T (average around EUR 300/tonne)

### 10.3.3 Examples of sewage sludge installations

#### 10.3.3.1 Bubbling fluidised bed with heat recovery, SNCR, EP, wet scrubbing and static coke filter

In the year 2000 54390 tonnes of sewage sludge and 3378 tonnes of waste oils as well as about 1000 tonnes of feeding stuff and solvents each were combusted in three fluidised bed reactors. General data of the fluidised bed reactors are shown in Table 10.73.

Fluidised bed reactors in the plant Simmeringer Haide	
Operator	Fernwärme Vienna GmbH
Start-up	1980/1992
Firing technology	Stationary fluidised bed reactors System Copeland
Sludge throughput	54390 t dry substance, corresponding to 1656000 m <sup>3</sup> thin slurry
Average net calorific value	15.7 MJ kg <sup>-1</sup> dry substance
Average gross calorific value	17.1 MJ kg <sup>-1</sup> dry substance
Theoretical rated thermal input	50 MW
Working hours line 1	2484
Working hours line 2	5603
Working hours line 3	8784

Table 10.73: General data of the fluidised bed reactors of the Plant Simmeringer Haide (2000)

#### Plant concept

A process flow scheme of one fluidised bed reactor is shown in Figure 10.11. One incineration line basically consists of the following units:

- fluidised bed reactor
- waste heat boiler
- flue-gas cleaning devices: SNCR process, electrostatic precipitator, acid and alkaline scrubber, activated coke filter
- multistage waste water treatment plant
- steam distribution system

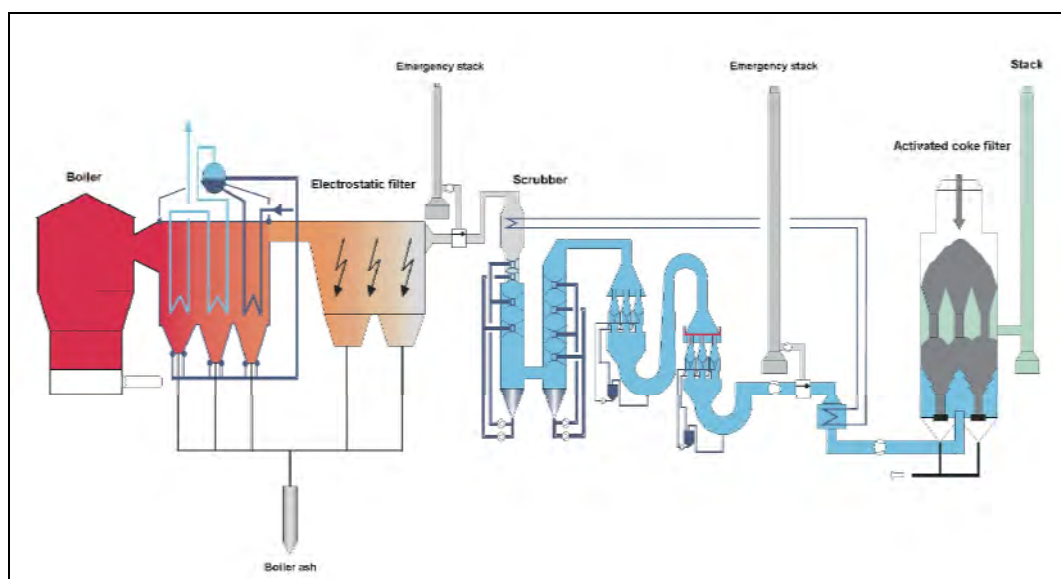

Figure 10.11: Process flow scheme of the fluidised bed reactors of the Plant Simmeringer Haide

Table 10.74 presents an input/output balance of the three fluidised bed reactors of the Plant Simmeringer Haide related to one tonne of waste.

Input related to 1 t waste		Output related to 1 t waste	
Electricity	590 kWh	Hydrochloric acid, 30 %	1.4 kg
Heavy fuel oil (1 % S)	0.059 m <sup>3</sup>	Quartz sand	13.7 kg
Fresh water	15530 l	Liquid nitrogen, 98.5 %	2.5 kg
Lime	4.7 kg	Heat	1.98 MWh
Sodium hydroxide, 50 %	16.5 kg	Electricity	0.363 kWh
Ammonia, 25 %	4.1 kg	Steam (p = 52 bar; T = 350 °C)	5.22 t
Precipitating agents, 15 %	0.05 kg	Fly and bed ash	264 kg
FeCl <sub>3</sub> , 40 %	2.1 kg	Filter cake (54.7 % H <sub>2</sub> O)	23 kg
Coke	3.4 kg	Cleaned waste water	1104 l
Polyelectrolyte	4.45 kg	Cleaned flue-gas (dry)	13110 Nm <sup>3</sup>

**Table 10.74: Input and output flows of the fluidised bed reactors (reference year: 2000)**

### Acceptance, treatment, storage and introduction of waste

The three fluidised bed reactors are constructed for the incineration of sewage sludge from the main waste water treatment plant of Vienna. Supplied thin sludge is dewatered by means of centrifuges. The resulting thick sludge has a dry substance content between 30 and 36 % and is supplied to the fluidised bed reactors.

### Supply of combustion air

Combustion air is preheated by means of an air preheater.

### Fluidised bed reactors

The three fluidised bed reactors of the plant Simmeringer Haide are constructed according to the principle of the stationary fluidised bed technology. The temperature of the fluidised bed is 750 °C. The combustion chamber is equipped with an oil burner.

### Utilisation of energy

Energy from the flue-gas is used for the production of steam (53 bar). Steam produced by the rotary kilns and the fluidised bed reactors is combined and converted to electricity by two turbines. Electricity is used for covering the own needs of the installation of the Plant Simmeringer Haide. Additionally the oven lines are equipped with a cogeneration (CHP) system which decouples heat for the district heating system of Vienna.

### Flue-gas cleaning system and emissions to the air

*Electrostatic precipitator:* In the first flue-gas cleaning step dust emissions are reduced to 10 - 30 mg Nm<sup>-3</sup>.

*Flue-gas scrubbing:* The wet flue-gas cleaning system consists of two cross flow scrubbers for separation of acid, water soluble gases as well as dust and heavy metals. The subsequent venturi scrubber is used for separation of fine dust and for preconditioning of flue-gases for an electrodynamic venturi scrubber.

*SNCR:* Nitrogen oxides are reduced by injection of an aqueous solution of ammonia into the flue-gas.

*Activated coke filter:* Post-treatment takes place in a countercurrent plant using activated coke separately for each combustion line. This unit consists of two parallel arranged adsorbers that are filled with lignite-furnace coke. The adsorbers for the fluidised bed reactors consist of 4 modules each, whereby each module is filled with 15 t adsorbent. Flue-gas flows through the layer from the bottom up while the coke slowly moves downwards.

Using these flue-gas cleaning measures emission levels shown in Table 10.75 are achieved:

Parameter	Emission (mg Nm <sup>-3</sup> ) <sup>a</sup>	Total mass (kg yr <sup>-1</sup> ) <sup>b,d</sup>	Specific emissions (g t <sup>-1</sup> ) <sup>c,d</sup>
Dust <sup>*</sup>	0.6	498.63	7.8
HCl <sup>*</sup>	0.11	91.41	1.45
HF	<0.05	41.55	0.65
SO <sub>2</sub> <sup>*</sup>	<sup>e</sup>		
CO <sup>*</sup>	4	3324.17	52.44
NO <sub>x</sub> as NO <sub>2</sub> <sup>*</sup>	100	83104.29	1311
Cr	0.0004	0.33	0.0052
As	<0.0001	0.083	0.0013
Ni	0.0006	0.499	0.0079
Cd	0.0006	0.499	0.0079
Hg	0.0015	1.25	0.02
Cu	0.0009	0.75	0.012
PAH	0.0069	5.73	0.09
NH <sub>3</sub>	3.55	2950.2	46.54
PCDD+PCDF	0.00079 ng TE Nm <sup>-3</sup>	0.66 mg yr <sup>-1</sup>	0.01 µg t <sup>-1</sup>

<sup>\*</sup> Continuous measurement  
<sup>a</sup> Half hourly average values in mg Nm<sup>-3</sup>; dioxin emissions are given in ng Nm<sup>-3</sup> (11 % O<sub>2</sub>; dry flue-gas; standard conditions)  
<sup>b</sup> In kg yr<sup>-1</sup>, dioxin loads in mg yr<sup>-1</sup>  
<sup>c</sup> Emissions related to one tonne used waste in g t<sup>-1</sup>; dioxin emissions in µg t<sup>-1</sup>  
<sup>d</sup> Total mass and specific emissions are calculated based on average half hourly mean values, using the quantity of dry flue-gas (13110 Nm<sup>3</sup> t<sup>-1</sup> waste) and the waste quantity (63390 t yr<sup>-1</sup>).  
<sup>e</sup> below detection limit (0.3 mg Nm<sup>-3</sup>)

**Table 10.75: Emissions to air from the fluidised bed reactors (reference year: 2000)**

### Waste water treatment and emissions to water

The waste water from the three fluidised bed reactors is precleaned together with those of the two rotary kilns. Afterwards it is conducted into the main waste water treatment plant of Vienna. Waste water cleaning is performed using gravity separation, neutralisation, flocculation, filtration and precipitation processes. Neutralisation is performed in order to separate HCl and HF.

### Waste

*Bed- and filter ash:* Bed- and filter ashes are landfilled.

*Filter cake:* The filter cake from the waste water cleaning plant is filled into “big bags” and landfilled.

Chemical data of wastes from the fluidised bed reactors are shown in Table 10.76. Results from leaching tests are presented in Table 10.77.



Parameter	Fly ash
TOC (%) (air dried basis - ad)	0.97
Cl (%) (ad)	0.18
SO <sub>3</sub> (%) (ad)	3.3
Main components (mg kg <sup>-1</sup> ) (dry basis)	
SiO <sub>2</sub>	225
Al	41948
MgO	25
Fe	179107
CaO	164
K <sub>2</sub> O	1.3
Heavy metals (mg kg <sup>-1</sup> )	
Zn	2738
Pb	378
Mn	414
Cr	108
Cd	10.4
As	11.6
Hg	0.76
Ni	87

**Table 10.76: Chemical data of wastes from the fluidised bed reactors (reference year: 2000)**

Parameter	Concentration (mg kg <sup>-1</sup> )
pH value	9.5
SO <sub>4</sub>	1284
Cl	58
NH <sub>3</sub> as N	0.75
NO <sub>3</sub>	5
NO <sub>2</sub>	0.1
Fe	0.01
Mn	<0.01
Ni	<0.1
Cd	<0.01
Cr	0.03
Cu	<0.01
Pb	0.1
Zn	0.04
Hg	0.001

**Table 10.77: Leaching tests according to ÖNORM S 2115 – fluidised bed reactors (reference year: 2000)**

### 10.3.3.2 Bubbling FB with CHP, SNCR, flue-gas re-circulation, EP, wet scrubbing and bag filters with coke/calcium carbonate injection

Total capacity 78840 t m<sub>T</sub>/yr, currently 42000 t of sewage sludge and 7000 t of rakings

Stationary fluidized bed furnaces

3 incineration lines with 26280 t m<sub>T</sub>/yr each

Start-up: 1997

Sewage sludge and rakings as incineration materials may be described as follows:

Parameter	Measure	Sewage sludge	Rakings
Calorific value	kJ/kg	3190 - 5300	2900 - 7000
Solid contents	% m <sub>T</sub>	39 - 46	22 - 34
Loss on ignition	% by weight	48 - 56	

**Table 10.78: Characterization of the incineration materials**

### Reduction of emissions into the air

The waste gas cleaning system consists of the following components:

- SNCR nitrogen removal
- Flue-gas recirculation
- Electrostatic filter (2-stage)
- HCl scrubber (pH value 2.3)
- SO<sub>2</sub> scrubber (1-stage neutralization with lime milk)
- Tissue filter with coke/calcium hydrate/calcium carbonate dosing

Waste gas quantity per line: 15000 m<sup>3</sup>/h

Parameter	Measure	Half-hour average values	Daily average values	Annual average values
Continuous measurement				
Total dust	mg/m <sup>3</sup>	<5	<2.5	0.2
HCl	mg/m <sup>3</sup>	<10	<5	0.2
SO <sub>x</sub>	mg/m <sup>3</sup>	<50	<20	3.3
NO <sub>x</sub>	g/m <sup>3</sup>	<0.220	<0.12	43
Total C	mg/m <sup>3</sup>	<10	<7	0.7
CO	mg/m <sup>3</sup>	<100	<20	2.4
Periodical measurement				
HF	mg/m <sup>3</sup>	<0.06	-	
Cd, Tl	mg/m <sup>3</sup>	<0.001	-	0.0002
Hg	mg/m <sup>3</sup>	<1	-	0.0008
Σ Sb, As, Pb, Cr, Co, Cu, Mn, Ni, V, Sn	mg/m <sup>3</sup>	<0.013	-	0.007
PCDD/PCDF, I-TE	ng/m <sup>3</sup>	<0.011	-	0.0012

**Table 10.79: Average values measured in clean gas (operating values) – BAT5**

### Reduction of emissions into the water

The waste gas cleaning system operates with zero waste water discharge.

### Energy utilization

With a combusted sewage sludge total of 102127 t (m<sub>T</sub> content approx. 42 %), there was an output of 48000 MWh electric power and 62630 MWh process steam.

### Noise emissions/immissions

No information.

**Costs**

- Investment costs: approx.  $180 \cdot 10^6$  DM
- Specific treatment costs: no information

**10.3.3.3 Bubbling FB Plant with CHP, EP and wet scrubbing**

- Total capacity 100000 t m<sub>T</sub>/yr
- Stationary fluidized bed furnaces
- 2 incineration lines with 30 t m<sub>T</sub>/h each

**Reduction of emissions into the air**

The waste gas cleaning system consists of the following components:

- Electrostatic filters
- 4-stage waste gas washing

Waste gas per line: 62535 m<sup>3</sup>/h

The incineration material sewage sludge can be described as follows:

Parameter	Measure	Filter cake
Calorific value	kJ/kg	13000
Solid content	% m <sub>T</sub>	45
Loss on ignition	% by weight	

**Table 10.80: Characterization of the incineration material**

Parameter	Measure	Half-hour average values	Daily average values	Annual average values
Continuous Measurement				
Total dust	mg/m <sup>3</sup>	<30	<10	
HCl	mg/m <sup>3</sup>	<60	<10	
SO <sub>x</sub>	mg/m <sup>3</sup>	<200	<50	
NO <sub>x</sub>	g/m <sup>3</sup>	<0.4	<0.2	
Total C	mg/m <sup>3</sup>	<20	<10	
CO	mg/m <sup>3</sup>	<100	<50	
Hg	mg/m <sup>3</sup>	<0.05	<0.03	
Periodic measurement (Average values over sample taking period)				
HF	mg/m <sup>3</sup>		<1	
Cd, Tl	mg/m <sup>3</sup>		<0.05	
Σ Sb, As, Pb, Cr, Co, Cu, Mn, Ni, V, Sn	mg/m <sup>3</sup>		<0.5	
PCDD/PCDF, I-TE	ng/m <sup>3</sup>		<0.1	

**Table 10.81: Average values measured in clean gas (operating values) – BAT6**

### Reduction of emissions to water

The waste water cleaning system consists of a chemical (heavy metal precipitation) and a biological phase.

Parameter	2-hour composite sample (mg/l)
Suspended solid matter	
Hg	0.05
Cd	0.05
Tl	-
As	-
Pb	0.1
Cr	0.5
Cu	0.5
Ni	0.5
Zn	1.0
PCDD/PCDF (ng I-TE/l)	
pH value	
Temperature	

**Table 10.82: Emission values of the waste water from the waste gas cleaning system before mixing (BAT6)**

### Energy utilization

#### Heat generation/output

Total heat generation: 70000 MWh

Internal consumption:

#### Power generation/output

Total power generation: 80000 MWh

Internal use (additional supplies included): 20000 MWh

Power output: 60000 MWh

### Noise emissions/immissions

Distance of plant to immision site: 1200 m

The immission values admissible according to Item 2.321 TA Noise are observed at the prominent immission sites.

### Costs

No information.

## 10.3.4 Examples of combined incineration of various wastes

### 10.3.4.1 Circulating FB for selected/pre-treated wastes with heat recovery, dry and wet FGT, SCR and ash treatment

Following types of waste are combusted at AVE - Reststoffverwertung Lenzing:

- packaging materials from the separated collection
- rejects
- light fractions/sieve overflow from mechanical-biological plants
- waste wood, particularly contaminated
- sewage sludge.

In 2000 134715 tonnes of waste were treated in total.

Types of waste	Waste quantity (t yr <sup>-1</sup> )
Plastic wastes	34454
Rejects	19464
Sewage sludge	31986
Mixed plastic fractions	41913
Old wood	6898

**Table 10.83: Types of waste and waste quantities treated at AVE - Reststoffverwertung Lenzing (reference year: 2000)**

General data of the fluidised bed reactor of AVE-RVL Lenzing are presented in Table 10.84

AVE - Reststoffverwertung Lenzing	
Operator	RVL GmbH
Start up	September 1998
Technology	Circulating fluidised bed reactor
Waste throughput (2001)	134715 t
Calorific value of the waste	6.5 - 29 MJ kg <sup>-1</sup>
Rated thermal input	110 MW <sub>th</sub>
Operating hours (2000)	About 6100

**Table 10.84: General data of the fluidised bed reactor of AVE-RVL Lenzing**

Fuel oil, natural gas and coal are used as additional fuels for start up and shut down if necessary. The maximum rated thermal input of the plant is about 110 MW as continuous load. The plant is constructed for the treatment of wastes with a mixed calorific value of 6.5 - 29 MJ kg<sup>-1</sup>. The required waste quantity is defined by the thermal output and is about 7 - 60 tonnes per hour.

### Plant concept

A process flow diagram of AVE - Reststoffverwertung Lenzing is shown in two following figure. The plant basically consists of the following units:

- delivery
- treatment and storage of waste
- fluidised bed combustion with fluidised bed cooler and afterburning chamber
- waste heat boiler
- dry, wet and catalytic flue-gas cleaning devices
- waste water treatment.

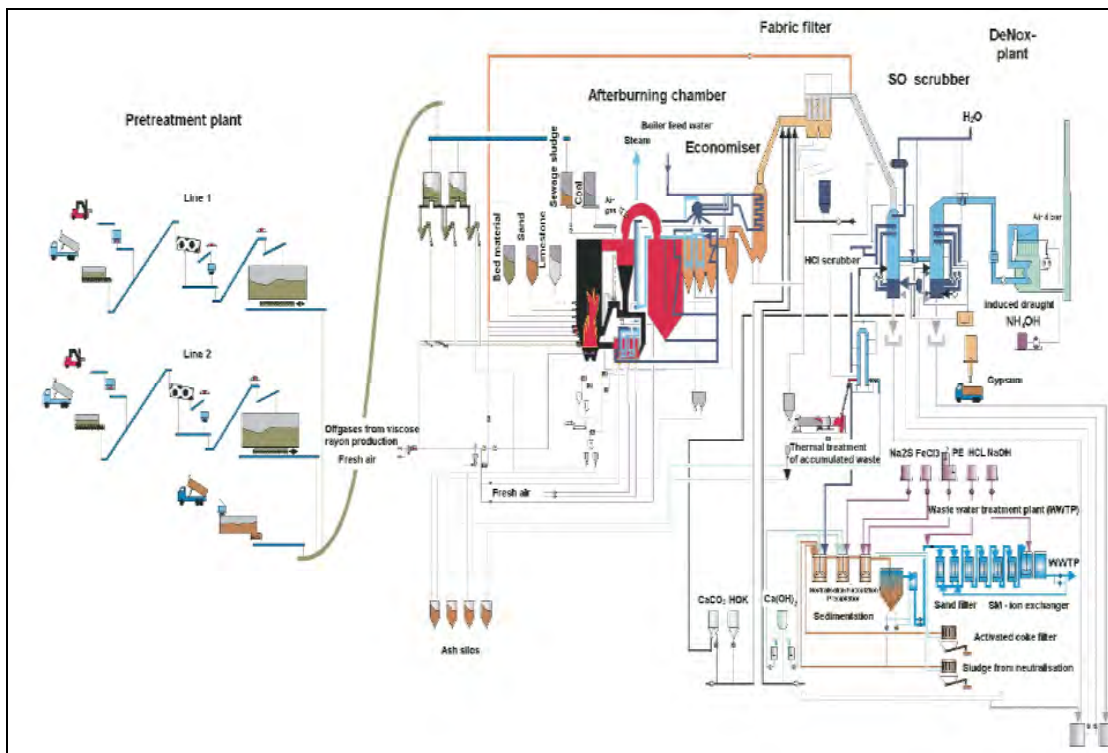

Figure 10.12: Process flow scheme of AVE-Reststoffverwertung Lenzing

### Acceptance, treatment and storage of waste

Delivered wastes such as packaging materials, rejects, light fraction and waste wood are declared by the deliverer and randomly tested by the operator, crushed and ground-up and interim stored in two daily bunkers that are situated directly near the boiler. Feeding of waste into the pulveriser, distribution in the daily bunker and discharge from the daily bunker is carried out in view of good homogenization.

Sewage sludge is directly dumped into two charging hoppers with discharge floor and interim stored in a silo. Sewage sludge is usually stabilized and combusted a few hours after delivery. In all cases transport from the pretreatment site to the boiler house is performed periodically with a pipe belt conveyor.

### Waste introduction and supply of combustion air

Ground up wastes such as plastics, rejects, sieve overflow and waste wood can be fed from the charging hopper into the firing zone using 3 pneumatic conveyors. For sewage sludge, a separate conveyor line with a plug screw as dosing device is provided. For oil and natural gas, burners and oil lances are installed. Coal can be fed with a separate dosing plant.

Exhaust gas from the neighbouring viscose rayon production containing  $H_2S$  (hydrogen sulphide) and  $CS_2$  (carbon disulphide) is used as combustion air. Exhaust gas from waste treatment and storage is dedusted with fabric filters and discharged into the atmosphere.

Combustion air is injected into the combustion chamber through the valve tray, two secondary air levels and several process-related places such as pneumatic conveyors and fluidising plates in the ash circle.

Dosing of particular wastes, co-fired fuels and combustion air is regulated by a firing performance control system. The demand for air and fuel is calculated online. The most important parameters such as calorific value and demand on combustion air are calculated automatically from process data and adapted to the combusted wastes.

### **Fluidised bed combustion with afterburning chamber**

The firing system mainly consists of:

- uncooled combustion chamber with slightly conical shape at the bottom and cylindrical form at the top
- cyclone
- afterburning chamber
- recirculation system for bed material with a siphon and a fluidised bed cooler.

Wastes are mixed homogeneously into the lower part of the combustion chamber and transported through the firing chamber with combustion air. In order to pre-separate SO<sub>2</sub> limestone is continuously added to the fluidised bed reactor of AVE - Reststoffverwertung Lenzing. This is a necessary procedure, because the exhaust air of the viscose rayon production that is used as combustion air contains high amounts of sulphurous compounds.

Bed material is separated from the flue-gas by a cyclone and fed into the siphon and fluidised bed cooler. A regulated quantity of bed material is passed over the fluidised bed cooler in order to extract heat from bed material either for steam production and superheating of steam or temperature regulation of the combustion chamber.

Flue-gases leaving the cyclone are fully combusted in the afterburning chamber at sufficient temperature and residence time.

#### **Waste heat boiler**

Flue-gases leaving the afterburning chamber are passing two vertical void zones with heating surfaces for evaporation, a horizontal zone with hanging heating surfaces for evaporation and superheating, a cyclone battery system and a preheater for feed water.

The steam system is connected to that of the adjacent Lenzing AG. Feed-water is pumped from the existing feed-water system into the boiler drum through the feed-water preheater. The water passes in the so-called natural circulation the evaporator surfaces in the fluidised bed cooler and the waste heat boiler and evaporates to some extent. Steam is separated from water in the steam drum and conducted into the steam network of Lenzing AG via the superheater. The first superheaters are arranged in the waste heat boiler, the last superheaters are arranged in the fluidised bed cooler.

#### **Utilisation of energy**

The steam parameters of the produced fresh steam are 78 bar and 500 °C. Electricity is produced by the turbines of Lenzing AG. The major part of the steam is withdrawn at 4 bar from the turbines and introduced into the process steam system of Lenzing AG. The overall demand for process steam is several times higher than the produced amount, exists all over the year and is covered by another fluidised bed reactor, two waste liquor boilers and an oil and gas fired reserve boiler.

#### **Flue-gas cleaning and emissions into the air**

*Dry flue-gas:* The dry flue-gas cleaning system is constructed as transport reactor with downstream fabric filter. The flue-gas temperature is regulated by the boiler to a constant value of about 160 °C.

The dry flue-gas cleaning system is used for dedusting, heavy metal precipitation and pre-separation of acid components such as HCl, HF and SO<sub>3</sub>. Lime, limestone and activated coke can be dosed into the ducts before the fabric filter. Separated dust is recirculated to some part.

*Wet flue-gas cleaning:* The wet flue-gas cleaning system consists of a co-current scrubber with acid circulating water, a countercurrent scrubber with gypsum suspension, droplet separators after each scrubber and a downstream steam heated gas preheater. The first step is used for the separation of acid components such as HCl, HF, SO<sub>3</sub> and for separation of volatile components.

The second step is used for the separation of SO<sub>2</sub>. The gypsum suspension of a partial flow is dewatered. Waste water from both scrubbers is treated by the waste water treatment plant. Cleaned waste water is partly returned to the first step. Limestone is injected in dry form as neutralizing agent.

*Catalytic flue-gas cleaning:* The catalytic flue-gas cleaning system is arranged in clean gas application with preheating by a gas/gas heat exchanger and a high pressure steam preheater. It is used for reduction of NO<sub>x</sub> and oxidation of organic pollutants such as dioxins and furans.

The whole plant is designed in terms of precautionary environmental protection what means that the particular plant elements are dimensioned and arranged in such a way that the prescribed emission limit values can be observed even in cases of highest possible pollutant loads of combusted wastes.

Achieved emission values of the fluidised bed reactor are shown in Table 10.85.

Parameter	Emission <sup>a</sup> (mg Nm <sup>-3</sup> )
Dust	0.6
HCl	0.8
HF	0.02
SO <sub>2</sub>	4.1
C <sub>org</sub>	0.6
CO	2.3
NO <sub>x</sub> as NO <sub>2</sub>	14.6
Σ Pb, Cr, Zn	0.003
Σ As, Co, Ni, Sb, Cu, Mn, V, Sn	0.00075
Cd+Tl	0.001
Hg	0.003
NH <sub>3</sub>	1.8
PCDD+PCDF	0.05 ng Nm <sup>-3</sup>
<sup>a</sup> Half hourly average values in mg Nm <sup>-3</sup> ; dioxin emissions are given in ng Nm <sup>-3</sup> (11 % O <sub>2</sub> ; dry flue-gas; standard conditions)	

**Table 10.85: Emissions to air from the fluidised bed reactor of AVE - Reststoffverwertung Lenzing**

### Waste water treatment

The waste water treatment plant consists of following units: Neutralisation, precipitation, flocculation and sedimentation and post treatment with gravel filters, ion exchanger and activated coke filter. For neutralisation lime milk is added.

### Waste

As far as waste from combustion is concerned a process concept was chosen by AVE-RVL Lenzing with the following goals:

- minimizing the amount of waste
- concentration of pollutants in small amounts of waste
- low concentration of volatile heavy metals in the main part of the ash
- minimization of the PCDD/F content in the predominant part of the ash
- reduction of the metallic Al content in the ash.

For that purpose the major part of the ash is separated in a cyclone battery at the end of the superheater zone. A part of this fine ash is recirculated into the combustion chamber again, in order to reduce volatile components and oxidise the major part of metallic Al.



Following wastes accumulate:

*Bed ash:* Coarse ash and interfering materials such as ferrous fragments and stones, that are separated by a coarse sieve and a magnetic separator.

*Coarse ash:* Overflow of the coarse sieve of the bed ash.

*Ferrous scrap:* Separated with magnetic separators from bed ash.

*Ash from pre-dedusting:* Fine ash with a grain size between 40 and 100  $\mu\text{m}$ , that is separated in the cyclone battery in the temperature range of 900 to 400  $^{\circ}\text{C}$ . Additionally fine ash can be withdrawn by the air separator in the ash cycle of the firing system.

*Eco- and fabric filter ash:* Very fine ash ( $<40 \mu\text{m}$ ) that arises in the flue-gas zone after pre-dedusting in the temperature range between 400 and 160  $^{\circ}\text{C}$  and in the dry flue-gas cleaning system. The mass fraction of very fine ash is less than 30 % of the overall ash but contains the main part of the volatile heavy metal and PCDD/F load. Very fine ash can be thermally post-treated in a rotary kiln. As this ash is disposed of underground anyway and already has the required properties without treatment, the rotary kiln was in operation only at the beginning of the test operation.

*Neutralisation sludge from the waste water treatment plant:* Inorganic sludge dewatered in chamber filter presses.

*Gypsum:* Arising in the suspension scrubber and dewatered in the centrifuge.

Bed ash, coarse ash and pre-dedusting ash are exempted and disposed of at landfills.

Eco- and fabric filter ash and neutralisation sludge are exported as hazardous wastes and disposed of underground.

#### 10.3.4.2 Fluidized bed plant for selected hazardous and non-hazardous wastes with heat recovery, EP, fabric filter, wet scrubber and SCR

##### Fluidised bed reactors of the waste incineration plant Arnoldstein

The fluidised bed reactor of the waste incineration plant Arnoldstein was upgraded in 2000 and is continuously operated since January 2001. In 2001 26000 tonnes of hazardous and non hazardous wastes (oily waste, solvent-water mixtures, treated and untreated wood waste, wood packaging, plastic waste, sludge and waste water) were combusted. The catalogue of key numbers of wastes permitted for thermal treatment can be found on the homepage of the waste incineration plant ([www.abrg.at](http://www.abrg.at)). General data of the fluidised bed reactor of the waste incineration plant Arnoldstein are given in Table 10.86.

Fluidised bed reactor Arnoldstein	
Operator	Asamer Becker Recycling Gesellschaft mbH
Start-up	1994
Start-up after overhaul	31.12.2000
Firing technology	Fluidised bed reactor
Waste throughput	26000 t
Average calorific value of the waste	5000 - 30000 $\text{kJ kg}^{-1}$
Thermal output	8 MW
Operating hours (test operation)	7300

**Table 10.86: General data of the fluidised bed reactor of the waste incineration plant Arnoldstein (reference year: 2001)**

### Plant concept

A process flow diagram is shown in Figure 10.13. The plant basically consists of the following units:

- treatment hall for crushing and grinding and mixing of wastes
- hall for intermediate storage of wastes
- firing system: Stationary fluidised bed reactor with waste heat boiler
- flue-gas cleaning devices: Electrostatic precipitator, two-stage wet scrubbing with NaOH scrubber, flow injection process and catalytic flue-gas cleaning system (clean gas application)
- central waste water treatment plant.

If necessary oil is used as additional fuel for start up and shut down.

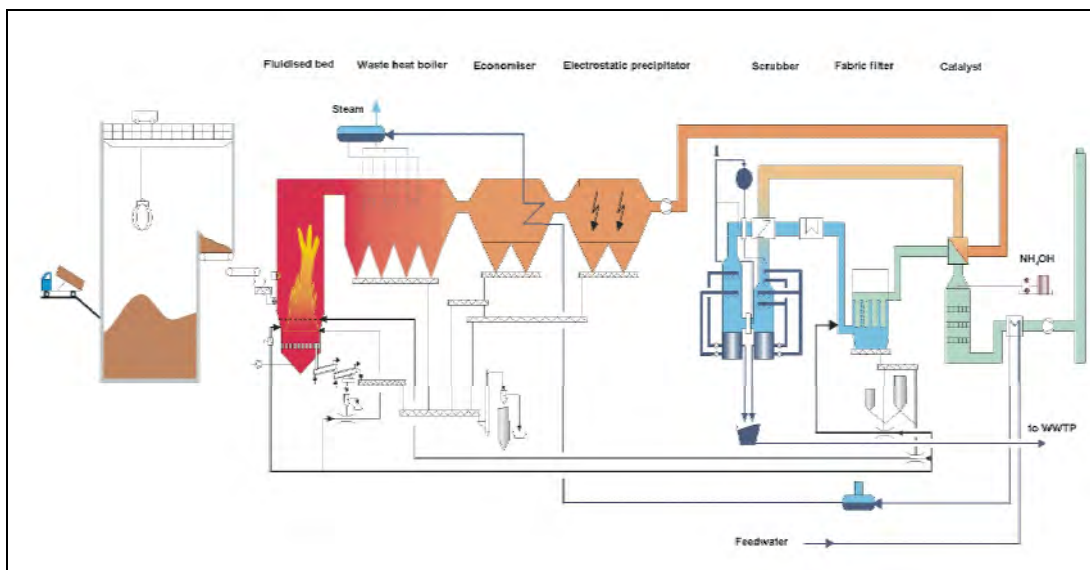

**Figure 10.13: Process flow scheme of the Fluidised bed reactors at Arnoldstein**

In Table 10.87 output flows of the fluidised bed reactors of the waste incineration plant Arnoldstein are shown.

Outputs	
Steam (25 bar; 180 °C)	4.5 t h <sup>-1</sup>
Ash	9000 t yr <sup>-1</sup>
Ferrous scrap	170 t yr <sup>-1</sup>
Filter cake	200 t yr <sup>-1</sup>
Waste water	13000 m <sup>3</sup> yr <sup>-1</sup>
Flue-gas	15500 Nm <sup>3</sup> h <sup>-1</sup>

**Table 10.87: Output flows of the fluidised bed reactors of the waste incineration plant Arnoldstein (reference year: 2001)**

### Acceptance, treatment and storage of waste

Incoming wastes are declared by the deliverer and always controlled optically by the operator of the waste incineration plant. Depending on the waste and on the deliverer singular or mixed samples are taken regularly in order to determine various parameters such as pH, calorific value, ignition loss, halogens, heavy metals, density and others. Waste is intermediately stored in boxes. Immediately before combustion they are transported to the waste bunker using a crane. Liquid waste fractions are intermediately stored in tanks.

**Waste introduction and supply of combustion air**

Mixed, crushed and grinded solid wastes are fed into the bunker by means of a crane. The bottom of this bunker is constructed as slowly moving conveyer belt. Waste discharged from the bunker falls onto another conveyor belt and is conveyed into a charging hopper for a dosing screw. Using the dosing screw solid wastes are charged regularly onto a so-called throw feeder, which distributes the waste uniformly across the fluidised bed. Liquid wastes are injected by means of a lance. For start up of the plant two burners firing fuel oil are installed. Exhaust air from the waste storage facilities and the tanks are used as combustion air.

The combustion air is introduced into the combustion chamber as secondary air through nozzles and as conveying air for recirculated bed ash. In order to regulate the dosage of waste, fuel oil and combustion air, a control system for the regulation of the firing performance is installed.

**Combustion chamber**

The combustion chamber is constructed as an uncooled, brick-lined stationary fluidised bed system. Immediately above the stationary fluidised bed reactor the afterburning zone with secondary air injection is arranged. Hydrated lime and limestone from the flow injection process are pneumatically conveyed into the combustion chamber for pre-separation of SO<sub>2</sub>.

**Waste heat boiler**

The waste heat boiler is constructed as a horizontal boiler with radiation heating surfaces in the first and convection surfaces in the second part. These heating surfaces are pure evaporating heating surfaces. The horizontal waste heat boiler is followed by a feed-water preheater. In the energy system saturated steam is produced which is fed into the local steam network using a pressure reducing valve.

**Flue-gas cleaning system and emissions into the air**

*Dedusting:* Dedusting of flue-gases leaving the boiler is performed by means of an electrostatic precipitator. The temperature of flue-gases entering the electrostatic precipitator depends on the boiler load and the travel time.

*Wet flue-gas cleaning:* The wet flue-gas cleaning system consists of a co-current scrubber with acid circulation water and a countercurrent scrubber with NaOH as neutralizing agent. Each scrubber is followed by a droplet separator. Heat from the flue-gases entering the scrubber is transferred to the flue-gases leaving the scrubber by means of a gas/gas heat exchanger. The outlet temperature can be regulated by a downstream steam heated gas preheater.

*Flow injection process:* The flow injection unit consists of a flue-gas channel with injection of furnace coke, limestone and hydrated lime and a fabric filter. The operating temperature is about 120 °C.

Added chemicals are recirculated several times and then injected into the combustion chamber.

*Catalytic flue-gas cleaning:* The catalytic flue-gas cleaning system is constructed as clean gas application with heat transfer system (gas/gas heat exchanger). It exclusively serves the function of NO<sub>x</sub> reduction. An aqueous solution of ammonia (25 %) is used as reducing agent. After the catalytic flue-gas cleaning system flue-gases are cooled in a heat exchanger. The heat is used for preheating water for the feed-water tank.

Using these cleaning steps emission levels shown in Table 10.88 are achieved.

Parameter	Emission (mg Nm <sup>-3</sup> ) <sup>a</sup>	Total mass (kg yr <sup>-1</sup> ) <sup>b, d</sup>	Specific emissions (g t <sup>-1</sup> ) <sup>c, d</sup>
Dust <sup>*</sup>	1.5	169.73	6.53
HCl	0.14	15.84	0.61
HF	0.038	4.3	0.16
SO <sub>2</sub> <sup>*</sup>	<5	565.75	21.76
C <sub>org</sub> <sup>*</sup>	<1	113.15	4.35
CO <sup>*</sup>	<5	565.75	21.76
NO <sub>x</sub> as NO <sub>2</sub> <sup>*</sup>	<150	16972.5	652.79
Cd	0.003	0.34	0.013
Hg	0.003	0.34	0.013
PCDD+PCDF	0.022 ng Nm <sup>-3</sup>	2.489 mg yr <sup>-1</sup>	0.096 µg t <sup>-1</sup>

<sup>\*</sup> Continuous measurement  
<sup>a</sup> Half hourly average values in mg Nm<sup>-3</sup>; dioxin emissions are given in ng Nm<sup>-3</sup> (11 % O<sub>2</sub>; dry flue-gas; standard conditions)  
<sup>b</sup> In kg yr<sup>-1</sup>, dioxin loads in mg yr<sup>-1</sup>  
<sup>c</sup> Emissions related to one tonne used waste in g t<sup>-1</sup>; dioxin emissions in µg t<sup>-1</sup>  
<sup>d</sup> Total mass and specific emissions are calculated based on average half hourly mean values, using the quantity of dry flue-gas (5388 Nm<sup>3</sup> t<sup>-1</sup> waste; calculated from the hourly flue-gas volume of 15500 Nm<sup>3</sup>, the operating hours and the waste input) and the waste quantity (26000 t yr<sup>-1</sup>).

**Table 10.88: Emissions to air from the waste incineration plant Arnoldstein (reference year: 2001)**

### Waste water treatment and emissions to water

Waste water from the fluidised bed reactors (13000 m<sup>3</sup> yr<sup>-1</sup> or 36 m<sup>3</sup> h<sup>-1</sup>) and landfill leachate are cleaned in the waste water treatment plant. After cleaning using heavy metal precipitation, neutralisation and gypsum precipitation the waste water is released into the receiving water.

Using these cleaning steps emission levels shown in Table 10.89 are achieved.

Parameter	Measured value (mg l <sup>-1</sup> )
pH value	7.2
Filterable substances	7
As	<0.01
Cd	<0.05
Total Cr	<0.05
Cu	<0.05
Fluoride	8
Ni	0.06
Hg	<0.005
Pb	<0.1
Sb	<0.1
Sulphate (SO <sub>4</sub> )	8000
Zn	<0.5
Cyanides (easy releasable)	<0.1
NH <sub>4</sub> – N	127
TOC	25
Phenol	<0.1
EOX	<0.1

**Table 10.89: Waste water parameters (composite sample) of the waste incineration plant Arnoldstein after waste water treatment (reference year: 2001)**

### Waste

Wastes arising from the whole process (bed ash, fly ash, gypsum and filter cake) are mixed, exempted and disposed of on a landfill for residual waste. Occurring metal scrap is recycled.

Parameter	Measured value (mg kg <sup>-1</sup> ) (dry basis)	Limit value
Hg	<1	20/3000
As	55	5000
Pb	2550	10000
Cd	20	5000

**Table 10.90: Chemical data of ash from the fluidised bed combustion of the waste incineration plant Arnoldstein (reference year: 2001)**

Parameter	concentration		Measured value (mg kg <sup>-1</sup> ) (dry basis)
	Limit value eluate (mg kg <sup>-1</sup> ) (dry basis)	Limit value concentrate (mg l <sup>-1</sup> ) (dry basis)	
Residue on evaporation	100000	30000	46000
pH value	6 - 13	2 - 11.5	10.2
Sb	50	5	1
As	50	5	<1
Pb	100	10	<1
Total Cr	300	30	<0.5
Cr (VI) as Cr	20	2	<0.2
Co	100	10	<0.5
Cu	100	10	<0.5
Ni	500	50	<0.5
Hg	0.5	0.05	<0.05
Tl	20	2	<0.5
V	200	20	<1
Zn	1000	100	<0.5
Sn	1000	100	<1
F	500	50	55
Ammonia as N	10000	1000	825

**Table 10.91: Concentration of pollutants in the eluate of ash from the waste incineration plant Arnoldstein (reference year: 2001)**

### 10.3.4.3 Water cooled grate furnace with CHP, cyclone de-dusting, SNCR and high dust SCR de-NO<sub>x</sub>, and dry fabric filter

Capacity 175000 t/yr

3 incineration lines, 2 with 12.5 t/h each and 1 with 15.5 t/h

reverse current furnace with reverse grate or with water-cooled feed grate

Incineration temperature 850 °C at a residence time of >2 seconds

Start-up: 1984, expansion: 1998 (line 3), modernization: 2000 (grate with water enclosure)

#### Reduction of emissions into the air

The waste gas cleaning system consists of the following components:

Line 1+2:

- Cyclone
- Evaporation cooler
- Current flow system with tissue filter
- DeNO<sub>x</sub> catalyser

Line 3:

- SNCR
- Cyclone
- DeNO<sub>x</sub> catalyser (high dust)
- Evaporation cooler
- Current flow system with tissue filter

Waste gas quantity per line: 2 x 70000 m<sup>3</sup>/h  
1 x 88000 m<sup>3</sup>/h

Manufacturer: Noell KRC GmbH

Special features: Waste gas recirculation behind multi-cyclone (branch current approx. 20–25 % of the waste gas quantity at 300–400 °C, economizer at 190 °C, injection into constriction between secondary incineration chamber and incineration chamber)

Parameter	Measure	Daily average value	Daily average value	Annual average value (reference year 2000)	Portion in % (over the annual operation time)	
		Minimum	Maximum		hav <sup>1</sup> >lv <sup>3</sup>	dav <sup>2</sup> >lv
Continuous measurement						
Total dust	mg/m <sup>3</sup>	0.04	15.15	0.45	0.0	0.0
HCl	mg/m <sup>3</sup>	0.24	15.15	3.27	0.0	0.5
SO <sub>x</sub>	mg/m <sup>3</sup>	0.56	42.56	11.41	0.0	0.0
NO <sub>x</sub>	g/m <sup>3</sup>	15.42	249	166	0.0	2.2
Total C	mg/m <sup>3</sup>	0.02	0.41	0.41	0.0	0.5
CO	mg/m <sup>3</sup>	1.29	70.67	6.39	0.2	0.5
Hg <sup>2</sup>	mg/m <sup>3</sup>	0.00014	0.01717	0.00413	0.04	0.0
Periodical measurement (average value over sample taking period)						
HF	mg/m <sup>3</sup>			<0.1		
Cd, Tl	mg/m <sup>3</sup>			0.0017		
Σ Sb, As, Pb, Cr, Co, Cu, Mn, Ni, V, Sn	mg/m <sup>3</sup>			<0.01		
PCDD/PCDF, I-TE	ng/m <sup>3</sup>			0.0053		
<sup>1</sup> hav – half-hour average value <sup>2</sup> dav – daily average value <sup>3</sup> lv – limit value						

**Table 10.92: Average values measured in clean gas (operating values)**

Toxic agent	Measuring device
Dust	Sick RM 210
HCl	Perkin Elmer MCS 100 E
C <sub>total</sub>	M&A Thermo FID
SO <sub>2</sub>	Perkin Elmer MCS 100 E
NO <sub>x</sub>	Perkin Elmer MCS 100 E
CO	Perkin Elmer MCS 100 E
Hg	Perkin Elmer ACE 100 Mercem
O <sub>2</sub> (secondary incineration)	Perkin Elmer MCS 100 E
Temperature (secondary incineration)	NiCr-Ni
Temperature (waste gas)	Sensycon PT 100

**Table 10.93: Measuring devices used for continuous measuring**

Toxic agent	Concentration in (mg/m <sup>3</sup> )		Deposition degree in %
	before cleaning	after cleaning	
HCl	1.700	10	99.4
HF	10	1	90
SO <sub>x</sub>	400	50	87.5
NO <sub>x</sub>	400	200	50
Dust	800	10	98.7
Cd/Tl	5	0.05	99
Hg	1	0.05	95
Other heavy metals	100	0.5	99.5
PCDD/PCDF (ng I-TE/ m <sup>3</sup> )	10	0.1	99

**Table 10.94: Deposition degrees in waste gas cleaning**

### Reduction of emissions into the water

There is no waste water resulting from waste gas cleaning, as the plant uses the conditioned dry process.

### Energy utilization (reference year 1999)

#### Heat generation/output

Heat generation in total:	115000 MWh
Internal consumption:	50000 MWh
Heat output, external:	65000 MWh

#### Steam generation/output

Fresh steam production:	580000 t/yr
-------------------------	-------------

#### Electric power generation/output

Electric power generation in total:	95000 MWh
Internal consumption (additional supplies incl.):	23100 MWh
Electric power output:	71900 MWh

Waste quantity combusted: approx. 174.100 t		Energy in (MWh)		Energy efficiency ratio in (%)		
		El. power	Heat	El. Power	Heat	Total
	<b>generated</b>	95.000	115.000	17 22.7 <sup>1</sup>	20.6 27.5 <sup>1</sup>	37.6 50.2 <sup>1</sup>
	<b>released</b>	71.900	65.000	12.9 17.2 <sup>1</sup>	11.7 15.6 <sup>1</sup>	24.6 32.8 <sup>1</sup>

<sup>1</sup> Energy efficiency ratio taking into account a combustion efficiency ratio of 75 % of the energy input

**Table 10.95: Energy efficiency ratio (supposed average calorific value Hu ≈ 11500 kJ/kg)**

**Residues – slag**

The contents of toxic agents are in the following ranges:

TOC	0.1 - 2 %
Loss on ignition	<3 %
PCDD/F	15 ng I-TE/kg
Cl <sup>-</sup>	4100 mg/kg
SO <sub>4</sub> <sup>2-</sup>	21000 mg/kg
Fluoride	600 mg/kg
As	1 - 20 mg/kg
Cd	1 - 25 mg/kg
Cr	100 - 1000 mg/kg
Cu	500 - 5000 mg/kg
Hg	0.01 - 0.5 mg/kg
Ni	30 - 600 mg/kg
Pb	300 - 6000 mg/kg
Zn	300 - 10000 mg/kg

**Table 10.96: Slag quality – BAT2**

**Noise emissions/immissions**

Allowable immission values according to Item 2.321 TI Noise are observed on the prominent immission sites.

**Costs**

- Investment costs incl. planning: 130 x10<sup>6</sup> DM
- Specific treatment costs: 120 to 339 DM/t

#### **10.3.4.4 Grate incinerator treating MSW, SS & CW with SNCR (urea), dry Na bicarbonate FGT, activated C injection and electricity generation**

**GENERAL information**

The plant is owned and operated by Tecnoborgo S.p.A. : 51 % Tesa S.p.A. which is the district for Waste and water treatment - City of Piacenza and 49 % private company.

Notable are : High electricity selling price (CIP6 contract), Project financing

The waste treated are: municipal solid waste; sewage sludge - delivered as liquid (3 % solids) and dried on site; clinical waste - received in plastic and cardboard hard boxes



**DESIGN/CONSTRUCTION DATA**

- combustion technique : Reverse acting reciprocating grates, 2 x 8.5 t/h
- plant capacity : design 136000 t/yr; permit 105000 t/yr; LCV range : 7540 - 13400 kJ/kg; nominal : 9600 kJ/kg
- design thermal input to the grate : 2 x 22.7 MW
- steam boiler, 39 bar, 390 °C; horizontal design, 3 free vertical passes and 1 horizontal
- energy valorisation : Electricity for export and internal use, steam for internal use only
- turbo-generator : 11.5 MW
- FGT system (Flue-gas Treatment) : Dry process, with active carbon injection and SNCR.
- SNCR de-NO<sub>x</sub> (solid urea). De-dusting by 1 ESP 2 fields (Electrostatic Precipitator) + 1 BHF (Bag House Filter). Dry scrubber with separate upstream injection of bicarb. De-diox by Active Carbon injection before the BHF
- no waste water from the FGT. Waste water treatment (precipitation) and release to the sewer
- bottom ash treatment : quenched scrap ferrous metals removal, landfilled
- FGT solid residues : Fly ash and Reaction products (salts) : landfilled
- material valorisation : Ferrous metals recovered
- start-up : 2002
- complies fully with the WID-2000 (Waste Incin. Directive).

**OPERATING DATA**

- year of reference (for the following data) : 2003
- waste throughput : 105000 t/yr. Municipal solid waste 90.5 %, Industrial waste 8 %, Clinical waste 0.5 %, Sewage sludge 1 %
- average NCV: 9630kJ/kg
- working hours including partial load hours (availability) : 7530 h/yr
- reagents consumption : Bicarb. : 15 kg/t // Urea : 2.2 kg/t // Activated carbon : 0.2 kg/t // Polyelectrolyte : 13.5 kg/tds
- imported electricity: 203280 kWh
- electricity consumption : 8.774.674 kWh
- electricity produced kWh, exported: 56.680.800 kWh
- material recovery : Ferrous metals : 2 %
- material residues : Bottom ash to landfill : 21 % // Fly ash + Reaction Products : 2.9 %.

Continuous concentrations measurement in clean gas. Annual average/Max 24h/Max 1/2h (over the year), in mg/Nm<sup>3</sup>:

Total dust : 1.2/1.3/0.8

HCl : 7.8/8.7/9.8

HF : 1.3/1.7

SO<sub>x</sub> as SO<sub>2</sub> : 3.2/5.3/48

TOC : 1.5/3.2/5.7

CO : 10/15/60

NO<sub>x</sub> : 180/199/400

Average value of concentration samplings in clean gas (periodic measurement of substances listed in the WID-2000) :

Cd + Tl : 0.000007 mg/Nm<sup>3</sup>

Hg : 0.000026 mg/Nm<sup>3</sup>

Sb+As+Pb+Cr+Co+Cu+Mn+Ni+V+Sn: 0.0041 mg/Nm<sup>3</sup>

PCDD/F : 0.004 ng<sub>iteq</sub>/m<sup>3</sup>

Concentration samplings in clean gas : (substances not listed in the WID-2000)

NH<sub>3</sub> : 8.9 mg/Nm<sup>3</sup>

Concentrations in clean waste water

Total suspended solids : 42 mg/l

Cd : <limit

Pb : 0.01 mg/l

Cr : 0.01 mg/l

Cu : 0.03 mg/l

Ni : 0.01 mg/l

Zn : 0.14 mg/l

pH value : 7.8

### **ECONOMICS**

Investment costs : EUR 60 million (VAT excluded, value 2001)

Gate fee :EUR 92.1/t (includes Investment cost, operating cost, residue disposal, energy and materials revenue, VAT excluded, value 2004);EUR 276.4/t for clinical waste residues.

#### **10.3.4.5 Grate incinerator treating MSW and industrial waste with EP, wet scrubbing, effluent evaporation, SCR and high pressure steam electricity generation**

##### **GENERAL information**

The plant is owned by a private company, Azalys, and operated by Novergie for the Municipality of Carrieres sous Poissy, Yvelines, Ile-de-France.

Municipal solid waste & Industrial waste are treated

Of particular note are:

- high steam characteristics
- high energy efficiency
- evaporation and crystallization of aqueous effluents
- SCR de-NO<sub>x</sub> and de-diox
- project financing.

##### **DESIGN/CONSTRUCTION DATA**

- combustion technique : Reciprocating grates, 2 x 7.5 t/h
- plant capacity : 115000 t/yr; nominal LCV : 10260 kJ/kg
- design thermal input to the grate : 2 x 21.4 MW
- steam boiler, 46 bar, 365 °C; vertical design, 4 passes
- energy valorisation : Electricity for export and internal use, steam for internal use only
- turbo-generator : 9.3 MW
- FGT system (Flue-gas treatment): ESP, Wet scrubbers, Wet ESP, SCR, Evapo-Crystallisation.
- de-dusting by ESP. Wet scrubbers, 3 stages : lime milk/HCl, lime milk/ SO<sub>x</sub>, venturi scrubber. De-diox and de-NO<sub>x</sub> by SCR (low dust, 280 °C)
- no aqueous effluents :
- FGT effluents : waste water treatment (precipitation, flocculation, filtration) + onsite offline evaporation & crystallization (salt recovery),
- other aqueous effluents are re-used in the plant (FGT)
- bottom ash : quenched, scrap ferrous metals removal, stored for ageing, recovered for road construction
- FGT solid residues : Fly ash : mixed with cement and landfilled (Hazardous waste landfill). filter cake : mixed with fly ash and cement and landfilled (Haz. landfill). Reaction products (salts)
- material valorisation : Bottom ash for road construction, Ferrous metals
- start-up : 1998
- complies with the emissions requirements of the WID-2000 since 7/1998, (Waste Incin. Directive).

**OPERATING DATA**

- reference year (for the following data) : 2003
- waste throughput : 106200 t/yr, 69 % municipal waste, 31 % industrial
- average NCV : 11390 kJ/kg
- working hours (availability) including partial load hours : line 1 : 8102/8760 hr; line 2 : 6500/8760 (Stopped 3 month for works; availability: 8000 hr)
- reagents consumption : Lime : 3.8 kg/tw
- energy input : Elec. : 9500 MWh, i.e. 80 kWh/t of waste (the TG set was stopped too during the works) // steam for incineration process (deaerator, soot blowing, ...)
- energy consumption : Elec. : 16 316 MWh, i.e. 153 kWh/tw of waste (including the imported 80 kWh/tw)
- electricity output : generated : 501 kWh/tw/exported 353 kWh/tw
- material recovery : Bottom ash for road construction : 23 600 t/yr // Ferrous metals : 289 t/yr
- material residues : Fly ash : 2345 t/yr // Filter cake : 476 t/yr // Salts : 1528 t/yr
- max 24h Concentrations in clean gas (continuous measurement) : HCl : <8 mg/Nm<sup>3</sup> // SO<sub>x</sub> <15 mg/Nm<sup>3</sup> // TOC : <2 mg/Nm<sup>3</sup> // CO : <25 mg/Nm<sup>3</sup> // NO<sub>x</sub> : <60 mg/Nm<sup>3</sup>
- average concentrations in clean gas (periodic measurement), 4 samplings : Cd : <0.009 mg/Nm<sup>3</sup> // Hg : <0.045 mg/Nm<sup>3</sup> // Sb : <0.009 mg/Nm<sup>3</sup> // As : <0.0015 mg/Nm<sup>3</sup> // Pb : <0.016 mg/Nm<sup>3</sup> // Cr : <0.09 mg/Nm<sup>3</sup> // Co : <0.0017 mg/Nm<sup>3</sup> // Cu : <0.0045 mg/Nm<sup>3</sup> // Mn : <0.012 mg/Nm<sup>3</sup> // Ni : <0.05 mg/Nm<sup>3</sup> // V : <0.0023 mg/Nm<sup>3</sup>
- PCDD/F (1 sampling) : :0.07 ngiteq/ Nm<sup>3</sup>.

#### **10.3.4.6 Grate incinerator treating MW, IW, SS and waste sorting refuse with SNCR, EP, wet scrubbing (on-line evaporation of effluent), bag filters and CHP**

**GENERAL information**

The plant is owned by a Municipal authority, Sidompe (122 municipalities, Ile-de-France, West of Paris), and operated by CNIM.

It treats Municipal waste, Industrial waste, Sorting refuse, Fresh (22 % dry) Sewage sludge

Of particular note are :

- FGT without aqueous effluent
- co-combustion of fresh sewage sludge with the waste
- hot water boiler for feeding a DH network and a steam boiler for electricity generation.
- the long history of the plant with successive upgrading
- ISO 14001 since 1999
- OHSAS 18001 (Safety & Hygiene, 2003).

## DESIGN/CONSTRUCTION DATA

- combustion technique : Reverse acting Reciprocating grates, 2 x 10t/h + 1 x 14.7t/h
- plant capacity : 240000 t/yr; nominal LCV : 7955 kJ/kg; range 1st & 2nd lines : 5025 - 10050 kJ/kg; range 3rd line : 5025 - 10470 kJ/kg
- design thermal input to the grate : 2 x 22 MW + 1 x 32.6 MW
- steam/hot water & Boiler design :
- lines 1 & 2 : hot water 37 bar, 220 °C; hot water boilers, vertical design, 2 passes
- line 3 : steam 42 bar 380 °C; steam boiler, vertical design, 4 passes
- energy valorisation :
- hot water (from lines 1 & 2) to D.H. network. Satisfy heat demand of 5000 equivalent habitants
- steam (from line 3) to TG set for export and internal use
- turbo-generator : 7 MW (steam from line 3 only)
- FGT system (Flue-gas Treatment) : ESP, Wet scrubbers and upstream online evaporation, with active carbon injection in the upstream evaporator and in the wet scrubbers.
- de-dusting by 2 ESP 3 fields (lines 1 & 2) or 1 BHF (line 3). Wet scrubbers 2 stages : lime & NaOH. Double active carbon injection : before the 1st BHF and in the wet scrubber. SNCR, urea (in 2005)
- no waste water from the FGT : (online evaporation of the aqueous effluents).
- other aqueous effluents : Re-use in the plant + Waste water treatment (precipitation) and release to the sewer. In 2005 no reject at all
- bottom ash : quenched, first removal of scrap ferrous metals on site. Offsite : second scrap ferrous metals removal, scrap non ferrous removal, stored for ageing, recovered for road construction
- FGT solid residues : Fly ash to landfill
- material valorisation : Bottom ash for road construction, Ferrous and non ferrous metals (offsite)
- start-up (main phases) : 1974 two grates, 1986 two hot water boilers, 1993 third line with its boiler + 3 FGT (wet without effluent), 2003 sewage sludge injection, 2004 de-diox, 2005 de-NO<sub>x</sub>
- complies with the WID-2000 (Waste Incin. Directive) emissions requirements since April 2004 except de-NO<sub>x</sub> SCR to be started in 9/2005.

**OPERATING DATA**

- reference year (for the following data) : 2003
- waste throughput 194964 t/yr; 67 % municipal waste, 30 % industrial, 3 % s. sludge
- average NCV : 9610 kJ/kg
- working hours (availability) including partial load hours L1 : 7854 h/yr, L2 : 7624 h/yr, L3 : 7662 h/yr
- reagents consumption : Lime 508 t/yr, NaOH 71 t/yr, urea, active carbon, Fresh water : 162043 m<sup>3</sup>/yr
- energy input : Electricity : 2688 MWh (when line nr 3 is off)
- electricity consumption : 19 GWh, including imported elec.
- energy output : Electricity exported : 28 285 MWh // Heat exported : 66 706 MWh
- material recovery : Bottom ash for road construction : 37477 t/yr // Ferrous metals : 3079 t/yr
- material residues : Fly ash : 5123 t/yr
- concentrations in clean gas (continuous measurement) "Annual average, plus maximum 1/2 hour average and max daily average :
- HCl in mg/Nm<sup>3</sup>: 0.4/<2.5/<5
- CO in mg/Nm<sup>3</sup>: 12.3/<30/<80
- average Concentrations in clean gas (periodic measurement); 2 samplings :
- Cd : <0.012 mg/Nm<sup>3</sup> // // Tl : <0.004 mg/Nm<sup>3</sup> // Cd + Tl : <0.016 mg/Nm<sup>3</sup> // Hg : <0.026 mg/Nm<sup>3</sup> // Sb : <0.014 mg/Nm<sup>3</sup> // As : <0.005 mg/Nm<sup>3</sup> // Pb : <0.061 mg/Nm<sup>3</sup> // Cr : <0.006 mg/Nm<sup>3</sup> // Co : <0.005 mg/Nm<sup>3</sup> // Cu : <0.021 mg/Nm<sup>3</sup> // Mn : <0.006 mg/Nm<sup>3</sup> // Ni : <0.006 mg/Nm<sup>3</sup> // V : <0.005 mg/Nm<sup>3</sup>
- Sb + As + Pb + Cr + Co + Cu + Mn + Ni + V : 0.127 mg/Nm<sup>3</sup>
- PCDD/F (1 sampling) : 0.036 ng iteq/Nm<sup>3</sup>
- concentrations in clean waste water (substances listed in the WID-2000) :
- total suspended solids : 9.4 mg/l // Hg : <0.002 mg/l // Cd : <0.01mg/l // As : <0.01mg/l// Pb : 0.09 mg/l// Cr : <0.05 mg/l // Cu : 0.14 mg/l // Ni : <0.05 mg/l // Zn : 0.16 mg/l
- PCDD/F : 0.005 ng i-TEQ/l

#### **10.3.4.7 Grate incinerator treating MSW, industrial and commercial waste with SNCR and semi-wet FGT and 20 bar 260 °C to district heating network**

**GENERAL information**

The owner of the plant is the Sitdce (Syndicat Intercommunal de Traitement des Dechets de Colmar et Environ) Municipal authority (Final customer). The operator is SCCU (Societe Colmarienne de Chauffage Urbain)

Waste type : Municipal solid waste & Industrial and commercial waste

Of note for : Recovered energy sent entirely to the Colmar D.H. network (4 km piping)

**DESIGN/CONSTRUCTION DATA**

- Combustion technique : Reverse acting Reciprocating grate, 2 x 6 t/h
- Plant Capacity : Nominal 78000 t/yr. Effective: 80 to 82000 t/yr. Design LCV range : 5440 - 9210 kJ/kg
- Design thermal input to the grate : 2 x 14.5 MW
- Steam Boiler: 20 bar, 260 °C, vertical design, with superheater & economiser
- Energy valorisation : Heat only; steam sent to the heating plant, itself connected to the District Heating network
- FGT system (Flue-gas Treatment) : SNCR + semi-wet process + active carbon injection
- De-dusting by BHF. Semi-wet scrubber with lime milk from hydrated lime. Active carbon injection before the scrubber. SNCR (solid urea)
- Aqueous effluents : No aqueous effluent from FGT. Other aqueous effluents (bottom ash releases, boilers blowdown, ground and road cleaning) : Waste water treatment (precipitation) and release to the sewer
- Bottom ash : quenched, scrap ferrous and non ferrous metals removal, recovered for road construction.
- FGT solid residues : Fly ash and Reaction products (salts) in hazardous waste landfill
- Material valorisation : Bottom ash for road construction. Ferrous and non-ferrous metals recovered. Screening residue 0.4 % to landfill.
- Start-up (main phases) : 1988; FGT upgrading in 2002 (de-NO<sub>x</sub> + de-diox)
- Complies with the WID-2000 emissions requirements since October 2002.

**OPERATING DATA**

- reference year (for the following data) 2003
- waste throughput : 80 400 t/yr; 70 % municipal waste, 10 % public direct supply, 18 % industrial and commercial waste
- average LCV : 10050 to 11700 kJ/kg
- working hours (availability) including partial load hours : line 1 : 8500 h/yr, line 2 : 8350 h/yr.
- energy output : Exported heat :124 000 MWh
- reagents consumption : Hydrated lime : 1420 t/yr; Urea: 235 t/yr; Active carbon : 45 t/yr; Water : 59 000 m<sup>3</sup>/yr
- material recovery : Bottom ash for road construction : 14800 t/yr; Ferrous metals : 2450 t/yr; Non Ferrous metals : 100 t/yr
- material residues : Bottom ash to landfill : 200 t/yr; FGT residues : 3350 t/yr
- annual average concentrations in clean gas (continuous measurement) :
- Dust: 1.7 mg/Nm<sup>3</sup> // HCl: 6.8 mg/Nm<sup>3</sup> // HF: 0.1 mg/Nm<sup>3</sup> // SO<sub>x</sub>: 9.5 mg/Nm<sup>3</sup> // COT: 1.9 mg/Nm<sup>3</sup> // CO: 15.4 mg/Nm<sup>3</sup> // NO<sub>x</sub>: 178 mg/Nm<sup>3</sup>
- concentrations in clean gas (periodic measurement of substances listed in the WID-2000):
- Cd: 0.0054 mg/Nm<sup>3</sup> // Tl: 0.0128 mg/Nm<sup>3</sup> // Cd+Tl: <0.019 mg/Nm<sup>3</sup> // Hg: 0.0014 mg/Nm<sup>3</sup> // Sb: 0.039 mg/Nm<sup>3</sup> // As: 0.029 mg/Nm<sup>3</sup> // Pb: 0.017 mg/Nm<sup>3</sup> // Cr: 0.016 mg/Nm<sup>3</sup> // Co: 0.005 mg/Nm<sup>3</sup> // Cu: 0.056 mg/Nm<sup>3</sup> // Mn: 0.01 mg/Nm<sup>3</sup> // Ni: 0.139 mg/Nm<sup>3</sup> // V: 0.009 mg/Nm<sup>3</sup>
- Sb+As+Pb+Cr+Co+Cu+Mn+Ni+V: <0.28 mg/Nm<sup>3</sup>
- PCDD/F: 0.006 ngiteq/Nm<sup>3</sup>
- concentrations in clean gas (substances not listed in the WID-2000) : NH<sub>3</sub>: 7.3 mg/Nm<sup>3</sup>
- concentrations in clean waste water (substances listed in the WID-2000) :
- M.E.S.: 90 mg/l // Hg: <0.0001 mg/l // Cd: 0.012 mg/l // As: 0.003 mg/l // Pb: 0.137 mg/l // Cr: 0.044 mg/l // Cu: 0.41 mg/l // Ni: 0.05 mg/l // Zn: 0.46 mg/l
- PCDD/F: <0.010 ngiteq/l.
- clean waste water (not listed in the WID-2000) : 5.5<pH<8.5

**ECONOMICS**

Investment costs : Plant 92 million French Francs, Connection to the heating plant 24 MFF (VAT excluded, 1986 value // In 2002, when euro replaced French Franc, EUR 1 = 6.55957 FRF) + Conformity with WID2000 : EUR 6.3 million (VAT excluded, 2002 value).

**10.3.4.8 Grate incinerator treating MSW, IW and clinical waste with SNCR, dry FGT and electricity generation****GENERAL information**

The plant is owned by the Syndicat Inter Arrondissement de Valorisation et d'Elimination des Déchets (Siaved) for the Arrondissements de Denain et de Saint Amand

The Waste treated are Municipal solid waste, Sorting refuse, Industrial waste water and Clinical waste received in metal containers.

Notable for the co-combustion of the Clinical waste and the long history of the plant with successive upgrading, no material residues.

**DESIGN/CONSTRUCTION DATA**

- combustion technique : Reverse acting Reciprocating grates, 2 x 5.5 t/h
- nominal capacity (permit) : 88000 t/yr
- design LCV : nominal : 8375 kJ/kg; range : 4600 - 9210 kJ/kg
- thermal input to the grate : 2 x 12.8 MW
- steam Boiler: 40 bar, 360 °C, vertical design, 3 passes
- energy valorisation : Electricity for export and internal use, steam for internal use only.
- turbo-generator : 6 MW
- FGT system (Flue-gas Treatment) : SNCR + Dry scrubbers+ Active carbon injection
- de-dusting by 1 ESP (1 field) and 1 BHF. Active carbon injection and bicarb. injection before the 2nd de-duster (BHF). De-NO<sub>x</sub> by SNCR (NH<sub>3</sub>), 900 °C.
- aqueous effluents : No waste water from the FGT. Internal industrial waste water evaporated in the furnace, sanitary water evacuated to the municipal waste water treatment, rainwater released to the river.
- bottom ash : quenched, scrap ferrous metals removal, recovered for road construction.
- material valorisation : Bottom ash : for road construction // Fly ash and Reaction products : recovery by underground storage // Ferrous metals // Non ferrous metals.
- start-up (main phases) : 1976 Furnace building, 2000 Active carbon + bicarb., 2004 boiler + SNCR.
- complies fully with the WID-2000 since 10/2004

## OPERATING DATA

- reference year (for the following data) Design/2004/2005 forecast
- waste throughput : 88000 t/yr, 80 % municipal waste, 15 % sorting refuse, 5 % clinical waste.
- average NCV: 8370 kJ/kg
- working hours (availability) including partial load hours : 8000 h/yr.
- reagents consumption : Bicarb. : 28 kg/t, Ammonia NH<sub>3</sub>: 3.1 kg/t, Activated carbon : 0.5 kg/t, Fresh water : 0.2 m<sup>3</sup>/t
- energy input : Petrol gas.
- electricity consumption : 80 kWh/t
- electricity generated : 530 kWh/t
- material recovery :
- bottom ash. Ratio 24 %. Recovered for road construction
- fly ash, reaction products. Ratio: 28 kg/tw. Recovery by underground storage "
- ferrous metals
- non ferrous metals
- material residues : none
- concentrations in clean gas (continuous measurement)
- Total dust : 3.27 mg/Nm<sup>3</sup> // HCl : 4.16 mg/Nm<sup>3</sup> // HF : 0.15 mg/Nm<sup>3</sup> // SO<sub>x</sub> : 1.94 mg/Nm<sup>3</sup> // TOC : 1.10 mg/Nm<sup>3</sup> // CO : 18.81 mg/Nm<sup>3</sup> // NO<sub>x</sub> : 137.54 mg/Nm<sup>3</sup> // NH<sub>3</sub> : 30.28 mg/Nm<sup>3</sup>
- concentrations in clean gas (periodic measurement of substances listed in the WID-2000)
- Cd : 0.0003 mg/Nm<sup>3</sup> // Tl : <0.0128 mg/Nm<sup>3</sup> // Hg : 0.0044 mg/Nm<sup>3</sup> // Sb : 0.0013 mg/Nm<sup>3</sup> // As : <0.0128 mg/Nm<sup>3</sup> // Pb : 0.0264 mg/Nm<sup>3</sup> // Cr : 0.0079 mg/Nm<sup>3</sup> // Co : <0.0128 mg/Nm<sup>3</sup> // Cu : 0.0025 mg/Nm<sup>3</sup> // Mn : 0.0232 mg/Nm<sup>3</sup> // Ni : <0.0130 mg/Nm<sup>3</sup> // V : <0.0128 mg/Nm<sup>3</sup> PCDD/F : 0.013 ngiteq/Nm<sup>3</sup>.
- Concentrations in clean gas (periodic measurement of substances not listed in the WID-2000) : NH<sub>3</sub> : 30.28 mg/Nm<sup>3</sup>

## ECONOMICS

Investment costs :EUR 20 million (for the boilers and SNCR upgrading phase).

### 10.3.4.9 Grate incinerator treating MSW, waste sorting residues and sludges with SNCR, dry FGT and heat supply to DH and local electricity plant

#### GENERAL information

The plant is owned by the Sivom of Metz for the City of Metz and operated by Haganis  
Waste type : Municipal solid waste & sorting refuse + Sludges (65 % by gravity in the waste hoppers).



**DESIGN/CONSTRUCTION DATA**

- combustion technique : Reciprocating grate, 2 x 8 t/h
- capacity : 90000 t/yr of waste & 18 000 t/yr of sludge
- design NCV : 9210 kJ/kg
- design thermal input to the grate : 2 x 20.5 MW
- steam Boiler : 24 bar, 325 °C, horizontal design, 3 vertical passes, 1 horizontal pass
- energy valorisation : Steam exported to a District heating network and to the Electricity Plant of Metz
- FGT system (Flue-gas Treatment) : Dry process with active carbon injection
- de-NO<sub>x</sub> by Urea SNCR in the first pass of the boiler. Dry scrubbers before BHF. De-dusting by 2 BHF(Bag House Filter). De-diox by active carbon injection
- aqueous effluents: No aqueous effluents from the FGT. Continuous blow-down recycled towards the bottom ash extractor
- bottom ash : quenched, scrap ferrous metals removal, scrap non ferrous removal (eddy current machine), stored for ageing
- FGT solid residues : Fly ash landfilled. Filter cake landfilled separately
- material valorisation :
- bottom ash for road construction
- ferrous metals
- non ferrous metals
- residual sodium salts recycled
- start-up whole plant : 2001
- complies fully with the WID-2000 since 2001 (Waste Incin. Directive).

**OPERATING DATA**

Reagents: Bicarbonate of soda, active carbon, liquid urea (32 %).

## 10.4 Energy calculation methodology and example calculation

Data appear in this document that was calculated and compiled by members of the *Energy sub-group of the TWG (ESG)*. This annexe provides the calculation method that was developed and used by some of the members of this sub-group when compiling the data shown. It should be noted that there exist various methods for the calculation of energy efficiency, however it is anticipated that the provision of the method developed and used by the TWG sub-group may help reader to understand the basis for the figures derived by energy sub-group work.

### 10.4.1 General explanations of terms and system boundary of the energy calculation

For the purposes of the BREF the calculation was restricted to the waste “incineration site”. The diagram below summarises the system inputs and outputs used by the BREF ESG:

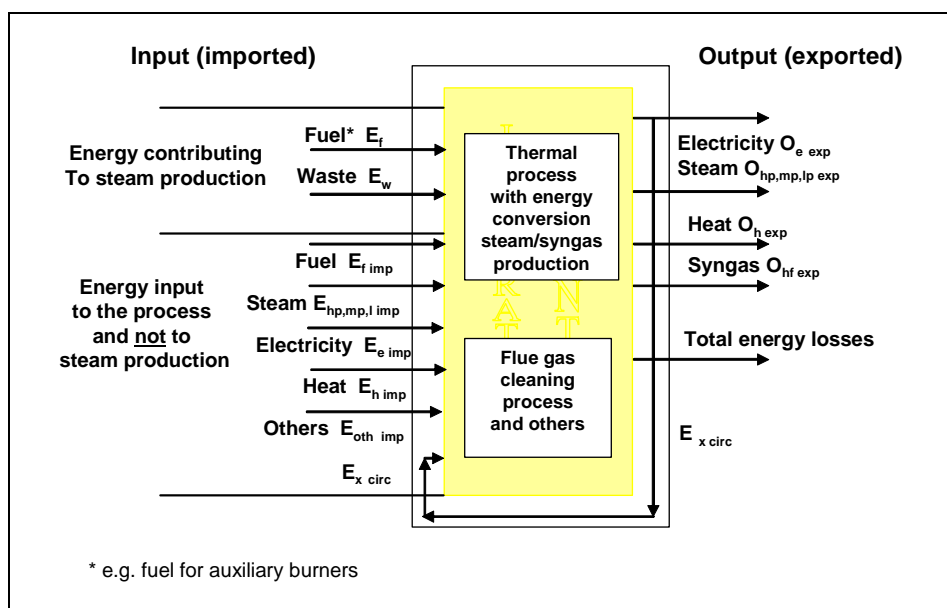

Figure 10.14: Summary of the energy system inputs and outputs used by BREF ESG

The main energy flows in waste incinerators can be summarised as:

#### a) Energy inputs (imported)

- only the energy input that is imported for the incineration process itself is included (see also d below). This will include, for example, the energy required for operation of a bulky waste shredder
- energy required to operate, for example, a full RDF plant (whether on site or not) is (for the purposes of this calculation) outside the system boundary and should not be included in the calculation (however it should be noted that this may be very significant if a wider life cycle boundary calculation is attempted)
- do not include energy required for waste collection, transportation and external pretreatment that is not necessary for the incineration process
- other energy imported to the site is included as an input e.g. electricity, natural gas for flue-gas reheating and/or oil for auxiliary burners, as long as they are partly or totally used to cover the energy needed in the incineration process.

**b) Energy conversion**

This is the energy from wastes/fuels that is converted in the incinerator to another form (e.g. steam or syngas) for export or circulation.

**c) Energy outputs (exported)**

- only the actual amount of energy exported is included (i.e. the gross production minus the energy circulated and consumed as losses to run the process itself)
- auxiliary on-site energy usage such as lighting and heating for offices should only be taken into account in the efficiency calculation if these figures are available and if a very precise balance is wanted. Otherwise this influence is considered small and can be neglected
- where energy is used on-site for another process (e.g. drying of sewage sludge or for running a district heating) this is counted as an output (export).

**d) Circulated energy as energy losses (for explanation see figure above)**

This is the energy that is generated by the process (e.g. steam/heat/electricity) that is then used in the process itself. This energy is not considered to count as a system input because it has not been imported from outside the system boundary. However, it is considered important that such circulation (if it is providing for energy losses) should be identified (as they substitute for imported energy) and should therefore be included in the check-list.

**10.4.2 Example of NCV calculation used by energy sub-group**

The data required for the calculation are generally available to incineration plant and are either measured or calculated from dimensioning figures such as steam parameters.

Method to calculate NCV of incinerated mono- and mixed waste

$$c = (1.133 \times (m_{st\ w}/m) \times c_{st\ x} + 0.008 \times T_b) / 1.085 \text{ (GJ/tonne)}$$

**c = lower (net) calorific value (NCV) of the incinerated waste with  $m_{st\ w} / m \geq 1$  (GJ/tonne)**

$$m_{st\ w} = m_{st\ x} - (m_f \times c_f \times c_{st\ x}) \times \eta_b$$

$m_{st\ w}$  = amount of the produced steam out of waste in the corresponding time period to  $m_{st\ x}$  e.g. per year (tonne/y)

$m_{st\ x}$  = total amount of the produced steam in a defined time period e.g. per year (tonne/y)

$m_f$  = amount of fuel with steam production (see  $E_f$  in checklist) in the corresponding time period to  $m_{st\ x}$  e.g. per year (tonne/y)

$m$  = amount of incinerated waste (see  $E_w$  in checklist) in a defined time period to  $m_{st\ x}$  e.g. per year (tonne/y)

$c_{st\ x}$  = net enthalpy of steam (enthalpy of steam minus enthalpy of boiler water) (GJ/tonne)  
see e.g. VDI Steam Tables in general constant for every single plant

$c_f$  = net calorific value of fuel with steam production see table 1 (GJ/tonne)

$T_b$  = temperature of flue-gas after boiler (at 4 – 12 %  $O_2$  in flue-gas) ( $^{\circ}C$ )

0.008 = spec. energy content in flue-gas (GJ/tonne  $\times$   $^{\circ}C$ )

1.133 and 1.085 = constant figures by regression equation

$\eta_b$  = efficiency of heat exchange (as approach 0.80)

**Reference:**

The basic equation for the calculation of NCV is taken from:

“Technology of Waste Incineration in Theory and Practice (Verbrennungstechnik von Abfällen in Theorie und Praxis)”, 1995 ed. by Reimann, D.O.; Hämmerli, H.; and

VDI “Steam Tables”, 1968 ed. by Schmidt, E.

**Example NCV calculation for an average MSW:**

Steam parameters 40 bar, 400 °C,  $C_{st\ hp} = 3.217$  GJ/tonne

boiler water 3.2 bar, 135 °C  $C_{st\ bw} = 0.565$  GJ/tonne

(constant for this W-t-E plant)  $C_{st\ x} = 2.652$  GJ/tonne

$m_{st\ hp} = 404623$  (tonne of HP steam)

$m_f = 95.875$  (tonne of fuel) (light oil)

$C_f = 42.73$  GJ/tonne

$\eta_b =$  efficiency of heat exchange (as approach 0.80)

$m_{st\ w} = m_{st\ hp} - (m_f \times (C_f / C_{st\ x}) \times 0.80)$

$= 404623 - (95.875 \text{ (tonne)} \times (42.73 / 2.652) \times 0.80) = 404623 - 1236 = 403387$  (tonne)

$m = 126692$  tonne of mixed municipal solid waste (MSW)

$T_b = 220$  °C (at 6 – 11 % O<sub>2</sub> in flue-gas)

$C = (1.133 \times (m_{st\ w} / m \times C_{st\ x}) + 0.008 \times T_b) / 1.085$

$C = (1.133 \times (403387 / 126692) \times 2.652) + 0.008 \times 220) / 1.085 = (9.567 + 1.760) / 1.085$

**NCV = C = 10440 GJ/ tonne = 2900 MWh/tonne as average of mixed MSW**

**10.4.3 Basic operational data for three examples of the energy calculation**

Annual basic operational data and figures may be collected using check-list shown below.

The check-list shown includes the data for the example of CHP production and export. Instead of generating an individual list for operational basic data of a plant the use of a standard checklist will deliver higher accuracy and reduce the risk of forgetting data to be taken into account for the energy calculation method.

Questionnaire/check-list	Accounting Period	Example calculation			
Name of the plant:	Plant W-t-E with CHP production				
<b>Scope of the energy balance: W-t-E plant only</b>					
INFORMATION TO BE PROVIDED FOR ENERGY CALCULATION AS BASIS FOR PLANT-EFFICIENCIES AND ENERGY RESULTS. THE YELLOW FIELDS SHOULD BE FILLED OUT WITH THE RELEVANT DATA FOR THE PLANT AS ACCURATE AS POSSIBLE:					
<b>Basic data</b>					
Name of plant	Example of calculation of combined heat and power recovery in accordance to BREF				
Name of company	(2. draft) chapter 3.5.4.3				
Address					
Contact person					
Telephone					
Fax					
E-mail					
<b>Energy input from waste for <math>E_w</math></b>					
Amount of all kind of waste incinerated, irrespective of type and composition	Total amount of waste incinerated	126692 [Mg](t) $E_w$			
Of which , waste for energetic recovery is included		0 [Mg](t)			
<b>Imported energy with steam/heatproduction <math>E_f</math> amount</b> (only one column to be filled out)					
Imported energy <b>contributing to steam-/heat production</b> , e.g. for auxiliary burners, start-up and shut-down proportionately <sup>1</sup> , etc.	Natural gas	NCV [GJ/10 <sup>3</sup> Nm <sup>3</sup> ]	0,0 [MWh]	0,000 [1000 Nm <sup>3</sup> ]	$E_f$
	Digestion gas	NCV [GJ/10 <sup>3</sup> Nm <sup>3</sup> ]	0,0 [MWh]	0,000 [1000 Nm <sup>3</sup> ]	$E_f$
	Light fuel oil	42,730 Hu [GJ/Mg]	0,0 [m <sup>3</sup> ]	95,9 [Mg](t)	$E_f$
	Heavy fuel oil	NCV [GJ/Mg]	0,0 [m <sup>3</sup> ]	0,0 [Mg](t)	$E_f$
	Other oils	NCV [GJ/Mg]	0,0 [m <sup>3</sup> ]	0,0 [Mg](t)	$E_f$
	Browncoal, Torf	NCV [GJ/Mg]		0,0 [Mg](t)	$E_f$
	Hard coal, Coke	NCV [GJ/Mg]		0,0 [Mg](t)	$E_f$
	Wood	NCV [GJ/Mg]		0,0 [Mg](t)	$E_f$
	RDF/SRF	NCV [GJ/Mg]		0,0 [Mg](t)	$E_f$
	Others	NCV [GJ/Mg]		0,0 [Mg](t)	$E_f$
	Hot water, district heat			0 [MWhh]	$E_f$
If this cannot be determined exactly, 50% <u>with</u> and 50% <u>without</u> , steam generation can be assumed in the case of <u>minor</u> use of auxiliary fuel and 70% <u>with</u> and 30% <u>without</u> , steam production in the case of <u>increased</u> use of auxiliary fuel					
<b>Imported energy without steam-/energy production <math>E_{v,imp}</math> amount</b> (only one column to be filled out)					
Imported energy <b>not contributing to steam-/heat production</b> , e.g. for flue gas treatment, start-up and shut-down proportionately <sup>1</sup> , etc.	Natural gas	NCV [GJ/10 <sup>3</sup> Nm <sup>3</sup> ]	0,0 [MWh]	[1000 Nm <sup>3</sup> ]	$E_{imp}$
	Digestion gas	NCV [GJ/10 <sup>3</sup> Nm <sup>3</sup> ]	0,0 [MWh]	[1000 Nm <sup>3</sup> ]	$E_{imp}$
	Methane	NCV [GJ/Mg]	0,0 [MWh]	[1000 Nm <sup>3</sup> ]	$E_{imp}$
	Light fuel oil	42,730 Hu [GJ/Mg]	0,0 [m <sup>3</sup> ]	95,9 [Mg](t)	$E_{imp}$
	Heavy fuel oil	NCV [GJ/Mg]	0,0 [m <sup>3</sup> ]	0,000 [Mg]	$E_{imp}$
	Gasoil, other oils	NCV [GJ/Mg]	0,0 [m <sup>3</sup> ]	0,000 [Mg]	$E_{imp}$
	Electricity			180,0 [MWh]	$E_{imp}$
	Hot water, district heat			0,000 [MWhh]	$E_{imp}$
	Steam <sub>hp,mp,lp</sub>	Steamquantity		0,000 [Mg](t)	$E_{at, hp,mp,lp, imp}$
		Steamparameters	[bar], [°C]		
		Boilerwater/condensate	[°C]		
	Steam <sub>hp,mp,lp</sub>	Steamquantity		0,000 [Mg](t)	$E_{st, hp,mp,lp, imp}$
		Steamparameters	[bar], [°C]		
		Boilerwater/condensate	[°C]		
alternative: Steam in MWh <sub>a</sub>			0 [MWhh]	$E_{st, hp,mp,lp, imp}$	
Others	NCV [GJ/Mg]		0,000 [Mg](t)	$E_{other, imp}$	

Table 10.97: Energy efficiency calculation data checklist 1

Circulated energy $E_{x,circ}$		Total energy $E_{x,circ}^*$	amount	Demand and losses out of $E_{x,circ}^{**}$
Self produced energy used in the process as circulated energy. For BREF/EUGH energy efficiency numbers and self demand only the energy losses (demand) are taken into account.	<b>Electricity</b>		17520,0 [MWhe]	17520,0 [MWhe] $E_{x,circ}$
	<b>Steam</b> hp,mp,lp	Steam quantity <sup>2</sup>	32458 [Mg](t)	32458 [Mg](t) $E_{st, hp,mp,lp, circ}$
		Steam parameters	[bar], [°C]	40 bar, 400 °C
		Boiler water/condensate	[°C]	135 °C
	<b>Steam</b> hp,mp,lp	Steam quantity <sup>3</sup>	68000 [Mg](t)	6800 [Mg](t) $E_{st, hp,mp,lp, circ}$
		Steam parameters	[bar], [°C]	40 bar, 400 °C
		Boiler water/condensate	[°C]	0 °C
	<b>Steam</b> hp,mp,lp	Steam quantity <sup>4</sup>	0 [Mg](t)	0 [Mg](t) $E_{st, hp,mp,lp, circ}$
		Steam parameters	[bar], [°C]	
		Steam backflow	[°C]	
<b>alternative: Steam in MWh<sub>a</sub>/a</b>			0 [MWhh]	0 [MWhh] $E_{st, hp,mp,lp, circ}$
<b>Hot water, district heat<sup>5</sup></b>			3760 [MWhh]	3760 [MWhh] $E_{h, circ}$
<b>Others</b>		NCV [GJ/Mg]		0,000 [Mg](t) $E_{other, circ}$

\* The total circulated energy should be filled in this column ( $E_{x,circ}$  total)

\*\* Only the part of the total circulated energy from \*, which is used to cover the total losses/demand of the process. These losses can reach as a maximum  $E_x$  circulated but are in general by far lower. For self control the information under <sup>2-6</sup> are necessary.

<sup>2-6</sup> to find out not only the consumption but even the real losses of the process it is necessary to distinguish between self produced energy which is circulated and only used for the purpose of covering energy losses e.g. heating up flue gas before chimney or SCR system without influencing the steam/heat production and used energy for mixed purposes of covering energy losses plus influencing/increasing the steam/heat production by circulation of this energy e.g. for heating up of the combustion air in the combustion chamber or boiler water/condensate as well as partially for cleaning up the boiler with steam. To take this fact into account the use of the circulated energy should be described in the following lines under # <sup>2-6</sup> in a short version and it's distribution in quantity of the total corresponding consumption too e.g. for heating up flue gas or heating up boiler water, to avoid misinterpretation.

Short wording of the consumed circulated energy and quantity of it's corresponding total amount:

<sup>2</sup> Consumption for heating up flue gases before SCR = 32458 Mg/a
<sup>3</sup> HP-steam for sootblowing 10 % of 68000 Mg/a = 6800 Mg/a
<sup>4</sup>
<sup>5</sup> Heating of plant buildings = 3760 MWhh
<sup>6</sup>

If multiple use of the consumed circulated energy is happening e.g. in more than one stage please indicate this too.

Exported energy $O_{x,exp}$		amount	
<b>Exported energy</b>	<b>Electricity</b>	31730,0 [MWhe] $O_{e, exp}$	
	<b>Steam</b> hp,mp,lp	Steam quantity	0,000 [Mg](t) $O_{st, hp,mp,lp, exp}$
		Steam parameters	[bar], [°C]
		Boiler water/condensate	[°C]
	<b>Steam</b> hp,mp,lp	Steam quantity	0,000 [Mg](t) $O_{st, hp,mp,lp, exp}$
		Steam parameters	[bar], [°C]
		Boiler water/condensate	[°C]
	<b>Steam</b> hp,mp,lp	Steam quantity	0,000 [Mg](t) $O_{st, hp,mp,lp, exp}$
		Steam parameters	[bar], [°C]
		Boiler water/condensate	[°C]
	<b>Steam</b> hp,mp,lp	Steam quantity	0,000 [Mg](t) $O_{st, hp,mp,lp, exp}$
		Steam parameters	[bar], [°C]
		Boiler water/condensate	[°C]
	<b>Heat</b>	Hot water quantity	0,000 [Mg](t) $O_{h, exp}$
		Hot water effluent	[°C]
		Hot water backflow	[°C]
	<b>alternative: Steam in MWh<sub>a</sub>/a</b>		0 [MWhh] $O_{st, hp,mp,lp, exp}$
<b>Hot water, district heat</b>		0,000 [MWhh] 137375,000 [MWhh] $O_{h, exp}$	
<b>Others</b>		NCV [GJ/Mg] 0,000 [Mg](t) $O_{other, exp}$	

Table 10.98: Energy efficiency calculation data checklist 2

Thermal output/ calorific value/ O <sub>2</sub> -content			
Total thermal output of the entire plant		54,0 [MW]	
Average net calorific value (NCV) of the waste, estimated by operator		no info	
Average net calorific value (NCV) of the waste, calculated by operator		10,440 [GJ/Mg]	
Average net calorific value (NCV) of the waste acc. to formula by BREF/BAT		10,439 [GJ/Mg]	
Boiler efficiency		83,0 [%]	
O <sub>2</sub> -content of the raw gas (after boiler) as dry		8,0 [%]	
O <sub>2</sub> content after stack of the clean gas as dry		8,5 [%]	
Steam/ hot water production			
Produced steam/hot water out of boiler or wherever useable steam/heat is produced during the total incineration process e.g. by heat pumps SCR with heat recovery, additional Eco's in the thermal waste treatment.	Steam hp,mp,lp after boiler	steam quantity	404623 [Mg](t)
		steam parameters [bar], [°C]	40 bar/400 °C
		condensate backflow [°C]	135°C
	Steam hp,mp,lp elsewhere	steam quantity	0,000 [Mg](t)
		steam parameters [bar], [°C]	
		condensate backflow [°C]	
	Steam	alternative: Steam produced in MWh <sub>h</sub> /a	0 [MWhh]
	Hot water after boiler	hot water quantity	0,000 [Mg](t)
		hot water effluent [°C]	
		hot water backflow [°C]	
	Hot water elsewhere	hot water quantity	0,000 [Mg](t)
		hot water effluent [°C]	
hot water backflow [°C]			
Hot water, district heat		0,000 [MWhh]	
Flue gas/ Clean gas			
Flue gas temperature after boiler (corresponding to the point of previous data for steam or hot water production)		220 [°C]	
Volume flow of clean gas (under standard conditions, dry)	3 lines	96603 [Nm <sup>3</sup> /h]	
Volume flow of clean gas as annual total for the entire plant (under standard conditions, dry)	3 lines	655000000 [Nm <sup>3</sup> /a]	
Flue gas temperature after chimney		120 [°C]	

Table 10.99: Energy efficiency calculation data checklist 3

#### 10.4.4 Energy calculation formulas with basic operational data for three examples of the energy calculation

The annual basic operational figures and data are the basis for the calculation of specific energy results and percentage efficiencies.

For the purpose of aggregation of data relating to the consumption/production/export of different sources of energy, reference has been made to GJ. However, more commonly electrical energy is reported as MWh<sub>e</sub>, and steam, heat and hot water as MWh<sub>h/st</sub>, therefore the examples are calculated with this unit.

To enable the comparison between different incineration plants in an easy and reliable way, simple formulas are adopted, all based on annual balances. Where used, international equivalency factors have been considered for energy conversions to obtain energy balances.

**Method 1:** Net annual specific (i.e. per tonne of waste treated) energy needed for and recovered by the installation, expressed as absolute and equivalent energy figures (N), in correlation to the quantity of incinerated waste (investigation period one year)

The specific value for the amount of energy produced, exported or needed per tonne of waste input is obtained simply by dividing the annual data by the waste throughput. The result delivers specific information for the considered plant because the NCV of waste itself is not taken into account.

This technique uses annual totals to calculate separate figures for:

- total specific energy demand of the entire plant per tonne of waste input  $N_{op\ sp}$
- total specific electrical energy production/export per tonne of waste input  $N_{e\ sp\ prod/exp}$
- total specific heat and steam production/export per tonne of waste input  $N_{h/st\ sp\ prod/exp}$
- total specific electrical energy and heat/steam production/export of the entire plant
- per tonne of waste input  $N_{e+h/st\ sp\ prod/exp}$

### Method 2: Percentage yield ( $\eta$ )

This method calculates the overall percentage of energy needed for and recovered by the installation in relation to the steam producing energy inputs from the waste, as well as other energy inputs (e.g. support fuels) i.e. in relation to the total energy input into the plant.

Because the energy content of the waste input is included, an advantage of this method is that comparison is possible between incineration plants, independent of the waste type. This calculation method is widespread and the results are generally well understood. If the NCV of the waste is not known, it can be obtained from knowledge of the produced steam.

In this method, separate efficiency values are calculated for electricity and heat production/consumption using absolute figures as well as energy equivalents. These figures may be added together to give a total efficiency figure.

This technique uses annual totals for the entire plant to calculate separate figures for:

- percentage of energy demand of the entire plant in relation to the total energy input  $\eta_{op\ sp}$
- percentage of electrical energy production/export in relation to the total energy input  $\eta_{e\ sp\ prod/exp}$
- percentage of heat and steam production/export in relation to the total energy input  $\eta_{h/st\ sp\ prod/exp}$
- percentage of electrical energy and heat/steam production/export of in relation to the total energy input  $\eta_{e+h/st\ sp\ prod/exp}$

The basic equations are:

#### a) in absolute figures

In this case all data even for electricity and heat must be counted not as equivalents but as measured figures e.g.  $MWh_e$  and  $MWh_h$  or in  $GJ_e$  and  $GJ_h$  all others with their energy content

#### b) in equivalent figures

Here all data for electricity and heat must be counted as equivalents e.g.  $MWh_{e\ equ}$  and  $MWh_{h\ equ}$  all others with their energy content

Specific energy demand of the entire plant in correlation to the quantity of waste incinerated:

$$N_{op\ sp} = (E_f + E_{x\ imp} + E_{x\ circ}) / m$$

a) as  $MWh_{op\ abs}/t$  (of waste) or  $GJ_{op\ abs}/t$  (of waste)

b) as  $MWh_{op\ equ}/t$  (of waste) or  $GJ_{op\ equ}/t$  (of waste)

Examples for specific energy demand in relation to the basis data of table 1 in section 3 and Chapter 3.5.5 of the BREF

a) plant with only electricity production (in absolute)  $N_{op\ sp} = (1138 + 1318 + 51269) / 126692 = 0.424 MWh\ abs/t$

b) plant with only electricity production (in equivalent)  $N_{op\ sp} = (1138 + 1612 + 80226) / 126692 = 0.655 MWh\ equ/t$

a) plant with only heat/steam production (in absolute)  $N_{op\ sp} = (1138 + 18838 + 33749) / 126692 = 0.424 MWh\ abs/t$

b) plant with only heat/steam production (in equivalent)  $N_{op\ sp} = (1138 + 47717 + 34121) / 126692 = 0.655 MWh\ equ/t$



- a) plant with CHP (in absolute)  $N_{op,sp} = (1138+1318+51269)/126692 = 0.424$  MWh abs/t  
 b) plant with CHP (in equivalent)  $N_{op,sp} = (1138+1612+80226)/126692 = 0.655$  MWh equ/t

Percentage of total specific energy demand of the entire plant in correlation to the total energy input

$$\eta_{op,abs} = ((E_f + E_{x,imp} + E_{x,circ}) / (E_f + E_{x,imp} + E_w)) \times 100 \{ \% \}$$

Examples for percentages of energy demand in connection with the basis data of table 1 in section 3.

- a) plant with only electricity production (in absolute)  $\eta_{op,abs} = ((1138+1318+51269)/(1138+1318+367406))*100 = 14.5$  (%)  
 b) plant with only electricity production (in equivalent)  $\eta_{op,equ} = (1138+1612+80226)/(1138+1612+367406))*100 = 22.4$  (%)  
 a) plant with only heat/steam production (in absolute)  $\eta_{op,abs} = (1138+18838+33749)/(1138+1318+367406))*100 = 13.9$  (%)  
 b) plant with only heat/steam production (in equivalent)  $\eta_{op,equ} = (1138+47717+34121)/(1138+1612+367406))*100 = 19.9$  (%)  
 a) plant with CHP (in absolute)  $\eta_{op,abs} = (1138+1318+51269)/(1138+1318+367406))*100 = 14.5$  (%)  
 b) plant with CHP (in equivalent)  $\eta_{op,equ} = (1138+1612+80226)/(1138+1612+367406))*100 = 22.4$  (%)

Total specific electricity produced in correlation to the quantity of waste incinerated:

$$N_{e,sp,prod} = (O_e + E_{e,circ}) / m$$

Total specific electricity exported in correlation to the quantity of waste incinerated:

$$N_{e,sp,exp} = (O_e,exp) / m$$

- a) as MWh<sub>op,abs</sub>/t (of waste) or GJ<sub>op,abs</sub>/t (of waste)  
 b) as MWh<sub>op,equ</sub>/t (of waste) or GJ<sub>op,equ</sub>/t (of waste)

Examples for specific electricity produced and exported:

- a) plant with only electricity production (in absolute)  $N_{e,sp,prod} = (17520+50800)/126692 = 0.539$  MWh<sub>e</sub> abs/t  
 $N_{e,exp} = (50800)/126692 = 0.401$  MWh<sub>e</sub> abs/t  
 b) plant with only electricity production (in equivalent)  $N_{e,sp,prod} = ((17520+50800)*2.6316)/126692 = 1.419$  MWh<sub>e</sub> equ/t  
 $N_{e,exp} = (50800*2.6316)/126692 = 1.055$  MWh<sub>e</sub> equ/t  
 a) plant with only heat/steam production (in absolute)  $N_{e,sp,prod} = (0)/126692 = 0.0$  MWh<sub>e</sub> abs/t  
 $N_{e,exp} = (0)/126692 = 0.0$  MWh<sub>e</sub> abs/t  
 b) plant with only heat/steam production (in equivalent)  $N_{e,sp,prod} = (0)/126692 = 0.0$  MWh<sub>e</sub> equ/t  
 $N_{e,exp} = (0)/126692 = 0.0$  MWh<sub>e</sub> equ/t  
 a) plant with CHP (in absolute)  $N_{e,sp,prod} = (17520+31730)/126692 = 0.389$  MWh<sub>e</sub> abs/t  
 $N_{e,exp} = (31730)/126692 = 0.250$  MWh<sub>e</sub> abs/t  
 b) plant with CHP (in equivalent)  $N_{e,sp,prod} = ((17520+31730)*2.6316)/126692 = 1.023$  MWh<sub>e</sub> equ/t  
 $N_{e,exp} = (31730*2.6316)/126692 = 0.659$  MWh<sub>e</sub> equ/t

Percentage of total electricity produced and exported in correlation to the total energy input:

$$\eta_{e,abs} = ((O_e + E_{e,circ}) / (E_f + E_{x,imp} + E_w)) \times 100 \{ \% \}$$

Examples for percentages of electricity produced and exported:

- a) plant with only electricity production (in absolute)  $\eta_{e,abs,prod} = (17520+50800)/(1138+1318+367406))*100 = 18.5$  (%)  
 $\eta_{e,abs,exp} = (50800)/(1138+1318+367406))*100 = 13.7$  (%)  
 b) plant with only electricity production (in equivalent)  $\eta_{e,equ,prod} = ((17520+50800)*2.6316)/(1138+1612+367406))*100 = 48.6$  (%)  
 $\eta_{e,equ,exp} = (50800*2.6316)/(1138+1612+367406))*100 = 36.1$  (%)  
 a) plant with only heat/steam production (in absolute)  $\eta_{e,abs,prod} = (0)/(1138+1318+367406))*100 = 0$  (%)  
 $\eta_{e,abs,exp} = (0)/(1138+1318+367406))*100 = 0$  (%)  
 b) plant with only heat/steam production (in equivalent)  $\eta_{e,equ,prod} = (0)/(1138+1612+367406))*100 = 0$  (%)  
 $\eta_{e,equ,exp} = (0)/(1138+1612+367406))*100 = 0$  (%)  
 a) plant with CHP (in absolute)  $\eta_{e,abs,prod} = (17520+31730)/(1138+1318+367406))*100 = 13.3$  (%)  
 $\eta_{e,abs,exp} = (31730)/(1138+1318+367406))*100 = 8.8$  (%)  
 b) plant with CHP (in equivalent)  $\eta_{e,equ,prod} = ((17520+31730)*2.6316)/(1138+1612+367406))*100 = 35.0$  (%)  
 $\eta_{e,equ,exp} = (31730*2.6316)/(1138+1612+367406))*100 = 22.6$  (%)

Total specific heat/steam produced in correlation to the quantity of waste incinerated:

$$N_{h/st\ sp\ prod} = (O_{h/st\ exp} + E_{h/st\ circ})/ m$$

Total specific heat/steam exported in correlation to the quantity of waste incinerated:

$$N_{h/st\ sp\ exp} = (O_{h/st\ exp})/ m$$

a) as  $MWh_{op\ abs}/t$  (of waste) or  $GJ_{op\ abs}/t$  (of waste)

b) as  $MWh_{op\ equ}/t$  (of waste) or  $GJ_{op\ equ}/t$  (of waste)

Examples for specific heat/steam produced and exported:

a) plant with only electricity production (in absolute)	$N_{h/st\ sp\ prod} = (33749+0)/ 12669$	=0.266 MWhh/st abs/t
	$N_{h/st\ exp} = (0)/ 126692$	=0.0 MWhh/st abs/t
b) plant with only electricity production (in equivalent)	$N_{h/st\ sp\ prod} = (34121+0)/ 126692$	=0.269 MWhh/st equ/t
	$N_{h/st\ exp} = (0)/ 126692$	=0.0 MWhh/st equ /t
a) plant with only heat/steam production (in absolute)	$N_{h/st\ sp\ prod} = (33749+242443)/ 126692$	=2.180 MWhh/st abs/t
	$N_{h/st\ exp} = (242443)/ 126692$	=1.914 MWhh/st abs/t
b) plant with only heat/steam production(in equivalent)	$N_{h/st\ sp\ prod} = (34121+242443)/ 126692$	=2.183 MWhh/st equ /t
	$N_{h/st\ exp} = (242443)/ 126692$	=1.914 MWhh/st equ /t
a) plant with CHP (in absolute)	$N_{h/st\ sp\ prod} = (33749+137375)/ 126692$	=1.351 MWhh/st abs/t
	$N_{h/st\ exp} = (137375)/ 126692$	=1.084 MWhh/st abs/t
b) plant with CHP (in equivalent)	$N_{h/st\ sp\ prod} = (34121+150961)/ 126692$	=1.461 MWhh/st equ /t
	$N_{h/st\ exp} = (150961)/ 126692$	=1.192 MWhh/st equ /t

Percentage of total heat/steam produced and exported in correlation to the total energy input:

$$\eta_{h/st\ abs} = ((O_{h/st} + E_{h/st\ circ})/(E_f + E_{x\ imp} + E_w)) \times 100 \{ \% \}$$

Examples for percentages of heat/steam produced and exported:

a) plant with only electricity production (in absolute)	$\eta_{h/st\ abs\ prod} = (33749+0)/ (1138+ 1318+367406)*100$	=18.5 (%)
	$\eta_{h/st\ abs\ exp} = (0)/ (1138+ 1318+367406)*100$	=13.7 (%)
b) plant with only electricity production (in equivalent)	$\eta_{h/st\ equ\ prod} = (34121+0)/ (1138+ 1612+367406)*100$	= 48.6 (%)
	$\eta_{h/st\ equ\ exp} = (0)/ (1138+ 1612+367406)*100$	= 36.1 (%)
a) plant with only heat/steam production (in absolute)	$\eta_{h/st\ abs\ prod} = (33749+242443)/ (1138+ 1318+367406)*100$	=71.3 (%)
	$\eta_{h/st\ abs\ exp} = (242443)/ (1138+ 1318+367406)*100$	=62.6 (%)
b) plant with only heat/steam production (in equivalent)	$\eta_{h/st\ equ\ prod} = (34121+242443)/ (1138+ 1612+367406)*100$	=66.4(%)
	$\eta_{h/st\ equ\ exp} = (242443)/ (1138+ 1612+367406)*100$	=58.2 (%)
a) plant with CHP (in absolute)	$\eta_{h/st\ abs\ prod} = (33749+137375)/ (1138+ 1318+367406)*100$	=9.1 (%)
	$\eta_{h/st\ abs\ exp} = (131730)/ (1138+ 1318+367406)*100$	=0.0 (%)
b) plant with CHP (in equivalent)	$\eta_{h/st\ equ\ prod} = (34121+150961)/ (1138+ 1612+367406)*100$	=9.2 (%)
	$\eta_{h/st\ equ\ exp} = (150961)/ (1138+ 1612+367406)*100$	=0.0 (%)

Total specific electricity and heat/steam produced in correlation to the quantity of waste incinerated:

$$N_{e+h/st\ sp\ prod} = N_{e\ sp\ prod} + N_{h/st\ sp\ prod}$$

Total specific electricity and heat/steam exported in correlation to the quantity of waste incinerated:

$$N_{e+h/st\ sp\ exp} = N_{e\ sp\ exp} + N_{h/st\ sp\ exp}$$

a) as  $MWh_{op\ abs}/t$  (of waste) or  $GJ_{op\ abs}/t$  (of waste)

b) as  $MWh_{op\ equ}/t$  (of waste) or  $GJ_{op\ equ}/t$  (of waste)

## Examples for specific heat/steam produced and exported:

a) plant with only electricity production (in absolute)	Ne+h/st sp prod = 0.539 + 0.266 Ne+h/st exp = 0.401 + 0	=0.805MWhe+h/st abs/t =0.401MWhe+h/st abs/t
b) plant with only electricity production (in equivalent)	Ne+h/st sp prod = 1.419 + 0.269 Ne+h/st exp = 1.055 + 0	=1.688 MWhe+h/st equ/t =1.055 MWhe+h/st equ /t
a) plant with only heat/steam production (in absolute)	Ne+h/st sp prod = 0 + 2.180 Ne+h/st exp = 0 + 1.914	=2.180 MWhe+h/st abs/t =1.914 MWhe+h/st abs/t
b) plant with only heat/steam production (in equivalent)	Ne+h/st sp prod = 0 + 2.183 Ne+h/st exp = 0 + 1.914	=2.183 MWhe+h/st equ/t =1.914 MWhe+h/st equ /t
a) plant with CHP (in absolute)	Ne+h/st sp prod = 0.389 + 1.351 Ne+h/st exp = 0.250 + 1.084	=1.740 MWhe+h/st abs/t =1.334 MWhe+h/st abs/t
b) plant with CHP(in equivalent)	Ne+h/st sp prod = 1.023 + 1.461 Ne+h/st e exp = 0.659 + 1.192	=2.484 MWhe+h/st equ /t =1.851 MWhe+h/st equ /t

**Percentage of total electricity and heat/steam produced and exported in correlation to the total energy input:**

$$\eta_{e+h/st \text{ abs}} = \eta_{e \text{ abs}} + \eta_{h/st \text{ abs}} \{\%\}$$

$$\eta_{e+h/st \text{ equ}} = \eta_{e \text{ equ}} + \eta_{h/st \text{ equ}} \{\%\}$$

## Examples for percentages of heat/steam produced and exported:

a) plant with only electricity production (in absolute)	$\eta_{e+h/st \text{ abs prod}} = 18.5 + 9.1$ $\eta_{e+h/st \text{ abs exp}} = 13.7 + 0$	= 27.6 (%) =13.7 (%)
b) plant with only electricity production (in equivalent)	$\eta_{e+h/st \text{ equ prod}} = 48.6 + 9.2$ $\eta_{e+h/st \text{ equ exp}} = 36.1 + 0$	= 57.8 (%) = 36.1 (%)
a) plant with only heat/steam production (in absolute)	$\eta_{e+h/st \text{ abs prod}} = 0 + 71.3$ $\eta_{e+h/st \text{ abs exp}} = 0 + 62.6$	= 71.3 (%) = 62.6 (%)
b) plant with only heat/steam production (in equivalent)	$\eta_{e+h/st \text{ equ prod}} = 0 + 66.4$ $\eta_{e+h/st \text{ equ exp}} = 0 + 58.2$	= 66.4(%) = 58.2 (%)
a) plant with CHP (in absolute)	$\eta_{e+h/st \text{ abs prod}} = 13.3 + 46.3$ $\eta_{e+h/st \text{ abs exp}} = 8.6 + 37.1$	= 59.6 (%) = 5.7 (%)
b) plant with CHP (in equivalent)	$\eta_{e+h/st \text{ equ prod}} = 35.0 + 50.0$ $\eta_{e+h/st \text{ equ exp}} = 22.6 + 40.8$	= 85.0 (%) = 63.3 (%)

**Boiler efficiency by heat/steam production in absolute figures in correlation to the total heat/steam producing energy input:**

$$\eta_b = (E_{h/st \text{ boiler}} / (E_f + E_w)) \times 100 \{\%\}$$

or because by losses of energy in the bottom ash, boiler dewatering and radiation estimated only 97 % released heat out of the furnace into the boiler

$$\eta_b (97 \%) = (E_{h/st \text{ boiler}} / 0.97 \times (E_f + E_w)) \times 100 \{\%\}$$

## Examples for boiler efficiency by heat/steam production in absolute figures in correlation to the total heat/steam producing energy input:

$$\begin{aligned} \eta_b &= (E_{h/st \text{ boiler}} / (E_f + E_w)) \times 100 &= (289207 / (1138 + 367407)) \times 100 &= 80.9 \text{ (\%)} \\ \eta_b (97 \%) &= (E_{h/st \text{ boiler}} / 0.97 \times (E_f + E_w)) \times 100 &= (289207 / (0.97 \times (1138 + 367407))) \times 100 &= 83.4 \text{ (\%)} \end{aligned}$$

### 10.4.5 Equations to calculate the plant efficiency (PI ef)

Annual basic operational figures and data are the basis for the calculation of the plant efficiency figures for the 3 examples given here. Both calculations provide a figure for the total efficiency of a plant (PI ef) but with different correlation.

The exported (sold) energy minus the net part of imported energy is divided by the total energy demand for the waste incineration process, including flue-gas cleaning, generation of heat and electricity etc.

Because the calculation does nearly not take into account the energy content in the waste, it only allows efficiency comparison of incinerators processing similar wastes.

$$PI_{ef} = (O_{exp} - (E_f + E_{imp})) / (E_f + E_{imp} + E_{circ})$$

all figures as equivalents in accordance to BREF, Chapter 3.5.6

$E_f$  = annual energy input to the system by fuels with steam production (GJ/y)

$E_{imp}$  = annual imported energy (Note: energy from the treated waste ( $E_w$ ) is not included)

$E_{circ}$  = annual energy circulated

$O_{exp}$  = annual exported energy (combined total of heat plus electricity as equivalents)

For the calculation of  $PI_{ef}$  the figures of section 3, enclosure 2 and 3 are used:

**plant with only electricity (13.7 % abs) export** (in equivalent)

$$PI_{ef} = (133685 - (1138+1612)) / (1138+1612+80226) = 1.58$$

**plant with only heat/steam (steam 62.6 % abs) export** (in equivalent)

$$PI_{ef} = (242443 - (1138+47717)) / (1138+47717+34121) = 2.33$$

**plant with CHP (H= 37.1 % abs and P= 8.6 % abs) export** (in equivalent)

$$PI_{ef} = (234462 - (1138+1612)) / (1138+1612+80226) = 2.79$$

**If the resulting figure is 0 or <0:**

*This means that no energy is exported (BREF) or produced (ECJ) but some imported energy is needed. This could be because no energy is recovered or because the energy that is recovered is consumed by the waste incineration process itself and not available for export and further more some imported energy is necessary.*

**If the result is higher than 1:**

*This shows that the plant minus imported energy with steam production is exporting (BREF) or producing (ECJ) more energy than that which is required to operate the total waste incineration process.*

This calculation does not require knowledge of the energy content of the waste. However, the result will be influenced by the waste energy content, and it can be expected that wastes with a higher energy content can result in greater energy exports, and hence higher values of  $PI_{ef}$ .

## 10.5 Example of a multi-criteria assessment used for the selection of FGT systems

The tables below provides an example of how, in an actual project, the assessment and selection of FGT system was carried out:

<b>Criteria</b>				
<b>Process</b>		<b>Semi-wet</b>	<b>Dry double filtration</b>	<b>Dry simple filtration</b>
<b>1- NATURAL RESOURCES CONSERVATION</b>				
a- raw material & EFFICIENCY (IPPC dir. Criterion nr. 9)				
water	m <sup>3</sup> /tw	0.2	-	-
reagents		lime	bicarb	bicarb
type	kg/tw	18	26	26
quantity	kg/tw	5	5	5
type 2 (ammonia)	kg/tw	0.6	0.6	0.6
type 3 (activated carbon)				
energy consumption		-	-	-
auxiliary fuel	kg/tw	25	30	20
electricity				
b- recovery & recycling (IPPC dir. Criterion nr.3)	kg/tw			
energy recovery				
metal recovery				
construction material recovery		-	possible	-
<b>salts recovery</b>				
<b>2- EMISSIONS</b>				
a- low waste techniques (IPPC dir. Criterion nr.1)				
liquid effluents		-	-	-
solid residues				
FGC residues quantity	kg/tw	54	-	45
Flying ashes		-	25	-
Salts		-	20	-
FGC/salts residues quality		calcic	sodic	sodic
b- emissions and impact (criteria nr 6 and 10 of the IPPC directive)				
emissions to atmosphere				
pollutants				
noise				
odours				
emissions to waters				
emissions via residues				
<b>3- RISKS (IPPC dir. Criteria nr. 2, 10, 11)</b>				
risks from hazardous substances		Little negligible	None negligible	None negligible
chemicals				
risks from emissions				
risks from accidents				
<b>4- ECONOMICS</b>				
costs and benefits (IPPC dir annex 4 introduction)				
annuity (corresp. to the invest. principal and interests)		2.8	3.5	2.7
		20.3	20.4	20.9
operation costs		23.1	23.9	23.6
availability				
construction duration				

**Table 10.100: Example of a multi-criteria assessment of FGT system selection**

200000 t <sub>w</sub> /yr								
Process Reagent(s)		Semi-wet Lime		Dry double filtration Bicarb		Dry simple filtration Bicarb		
<b>I) Variables costs:</b>								
<b>Reagents:</b>	Unit (u)	Cost (€u)	Quant. (u/t <sub>w</sub> )	Cost (€t <sub>w</sub> )	Quant. (u/t <sub>w</sub> )	Cost (€t <sub>w</sub> )	Quant. (u/t <sub>w</sub> )	Cost (€t <sub>w</sub> )
Lime	Kg	0.1	18	1.8				
sodium bicarbonate	Kg	0.2			26	5.2	26	5.2
ammonia	Kg	0.15	5	0.8	5	0.8	5	0.8
activated carbon	Kg	1.5	0.6	0.9	0.6	0.9	0.6	0.9
<b>Utilities:</b>								
water	m <sup>3</sup>	0.5	0.2	0.1				
electricity	kWh	0.04	25	1.0	30	1.2	20	0.8
<b>1- Total reagents and utilities</b>		<b>€t<sub>w</sub></b>		<b>3.8</b>		<b>7.3</b>		<b>6.9</b>
<b>Residues and effluents:</b>								
flying ashes	Kg	0.27			25	6.8		
FGC Residues	Kg	0.27	54	14.6			45	12.2
salts	Kg	0.20			20	4.0		
<b>2- Total residues and effluents</b>		<b>€t<sub>w</sub></b>		<b>14.6</b>		<b>10.8</b>		<b>12.2</b>
<b>TOTAL 1+2</b>		<b>€t<sub>w</sub></b>		<b>18.4</b>		<b>10.8</b>		<b>19.0</b>
<b>3- Total workforce</b>		<b>€t<sub>w</sub></b>		<b>0.2</b>		<b>0.2</b>		<b>0.2</b>
<b>4- Total daily maintenance</b>		<b>€t<sub>w</sub></b>		<b>0.5</b>		<b>0.6</b>		<b>0.5</b>
<b>II) Fixed costs:</b>								
<b>5- Provision for mainten. &amp; renewal</b>		<b>€t<sub>w</sub></b>		<b>1.3</b>		<b>1.6</b>		<b>1.2</b>
<b>6 Annuity (corresp. to the invest. principal + interest)*</b>		<b>€t<sub>w</sub></b>		<b>2.8</b>		<b>3.5</b>		<b>2.7</b>
<b>Total variable costs 1+2+3+4</b>		<b>€t<sub>w</sub></b>		<b>19.1</b>		<b>18.8</b>		<b>19.7</b>
<b>Total variable costs 5+6</b>		<b>€t<sub>w</sub></b>		<b>4.1</b>		<b>5.0</b>		<b>3.9</b>
<b>GLOBAL COST</b>		<b>€t<sub>w</sub></b>		<b>23.1</b>		<b>23.9</b>		<b>23.6</b>

\*Fixed rate 6 % - duration 20 years

Table 10.101: Example of a multi-criteria cost assessment used for comparing FGT system options